

Regular Session

RS

Milwaukie City Council

COUNCIL REGULAR SESSION

REVISED AGENDA

City Hall Council Chambers, 10501 SE Main Street
& Zoom Video Conference (www.milwaukieoregon.gov)

JUNE 4, 2024

(Revised May 31, 2024)

Council will hold this meeting in-person and by video conference. The public may come to City Hall, join the Zoom webinar, or watch on the [city's YouTube channel](#) or Comcast Cable channel 30 in city limits. For Zoom login visit <https://www.milwaukieoregon.gov/citycouncil/city-council-regular-session-373>.
Written comments may be delivered to City Hall or emailed to ocr@milwaukieoregon.gov.

Note: agenda item times are estimates and are subject to change.

Page #

- 1. **CALL TO ORDER** (6:00 p.m.)
 - A. **Pledge of Allegiance**
 - B. **Native Lands Acknowledgment**

- 2. **ANNOUNCEMENTS** (6:01 p.m.) 2

- 3. **PROCLAMATIONS AND AWARDS**
 - A. **Pride Month – Proclamation** (6:05 p.m.) 5
Presenter: Shane Abma, City Councilor
 - B. **Juneteenth – Proclamation** (6:15 p.m.) 6
Presenter: Lisa Batey, Mayor

- 4. **SPECIAL REPORTS**
 - A. **None Scheduled.**

- 5. **COMMUNITY COMMENTS** (6:25 p.m.)
To speak to Council, please submit a comment card to staff. Comments must be limited to city business topics that are not on the agenda. A topic may not be discussed if the topic record has been closed. All remarks should be directed at the whole Council. The presiding officer may refuse to recognize speakers, limit the time permitted for comments, and ask groups to select a spokesperson. **Comments may also be submitted in writing before the meeting, by mail, e-mail (to ocr@milwaukieoregon.gov), or in person to city staff.**

- 6. **CONSENT AGENDA** (6:30 p.m.)
Consent items are not discussed during the meeting; they are approved in one motion and any Council member may remove an item for separate consideration.
 - A. **Approval of Council Meeting Minutes of:** 9
 - 1. **May 7, 2024, work session, and**
 - 2. **May 7, 2024, regular session.**
 - B. **Appointments to City Boards and Committees – Resolution** 16
 - C. **Authorization of a Broadcast Services Contract – Resolution** 21
 - D. **Authorization of an Audit Services Contract – Resolution** 25
 - E. **Authorization of a Fleet Fuel Services Purchase** (removed from the agenda)
 - F. **Approval of a Collective Bargaining Agreement (CBA) with the Milwaukie Police Employees Association (MPEA) – Resolution** 28

7. BUSINESS ITEMS

A. None Scheduled.

8. PUBLIC HEARINGS

- A. 2025-2026 Consolidated Fee Schedule Adoption – Resolution (6:35 p.m.) 32**
Staff: Michael Osborne, Finance Director
- B. 2025-2026 State Revenue Sharing Election – Resolutions (2) (6:50 p.m.) 100**
Staff: Michael Osborne, Finance Director
- C. 2025-2026 Biennial City Budget and Capital Improvement Plan (CIP) Adoption – Resolution (7:05 p.m.) 104**
Staff: Michael Osborne, Finance Director

9. COUNCIL REPORTS (7:35 p.m.)

10. ADJOURNMENT (7:40 p.m.)

Milwaukie Redevelopment Commission (MRC) Meeting.

After the regular session Council will meet as the MRC. For information about that meeting visit <https://www.milwaukieoregon.gov/bc-rc/redevelopment-commission-16>.

Executive Session.

After the MRC meeting, Council will meet in executive session pursuant to Oregon Revised Statute (ORS) 192.660 (2)(h) to consult with counsel concerning the legal rights and duties of a public body with regard to current litigation or litigation likely to be filed, and (f) to consider information or records that are exempt from disclosure. (second citation added)

Meeting Accessibility Services and Americans with Disabilities Act (ADA) Notice

The city is committed to providing equal access to public meetings. To request listening and mobility assistance services contact the Office of the City Recorder at least 48 hours before the meeting by email at ocr@milwaukieoregon.gov or phone at 503-786-7502. To request Spanish language translation services email espanol@milwaukieoregon.gov at least 48 hours before the meeting. Staff will do their best to respond in a timely manner and to accommodate requests. Most Council meetings are broadcast live on the [city's YouTube channel](#) and Comcast Channel 30 in city limits.

Servicios de Accesibilidad para Reuniones y Aviso de la Ley de Estadounidenses con Discapacidades (ADA)

La ciudad se compromete a proporcionar igualdad de acceso para reuniones públicas. Para solicitar servicios de asistencia auditiva y de movilidad, favor de comunicarse a la Oficina del Registro de la Ciudad con un mínimo de 48 horas antes de la reunión por correo electrónico a ocr@milwaukieoregon.gov o llame al 503-786-7502. Para solicitar servicios de traducción al español, envíe un correo electrónico a espanol@milwaukieoregon.gov al menos 48 horas antes de la reunión. El personal hará todo lo posible para responder de manera oportuna y atender las solicitudes. La mayoría de las reuniones del Consejo de la Ciudad se transmiten en vivo en el [canal de YouTube de la ciudad](#) y el Canal 30 de Comcast dentro de los límites de la ciudad.

Executive Sessions

The City Council may meet in executive session pursuant to Oregon Revised Statute (ORS) 192.660(2); all discussions are confidential; news media representatives may attend but may not disclose any information discussed. Final decisions and actions may not be taken in executive sessions.



COUNCIL REGULAR SESSION

City Hall Council Chambers, 10501 SE Main Street
& Zoom Video Conference (www.milwaukieoregon.gov)

2404th Meeting

MINUTES

JUNE 4, 2024

Council Present: Councilors Shane Abma, Adam Khosroabadi, Rebecca Stavenjord, and Council President Robert Massey, and Mayor Lisa Batey

Staff Present: Keisha Brewster, Administrative Specialist III
Joseph Briglio, Acting Assistant City Manager
Matt Deeds, Assistant Finance Director
Shawn Flye, Cross Connection Specialist
Jessalynn Gale, Children's Librarian
Justin Gericke, City Attorney
Ben Green, Engineering Technician I
Adam Heroux, Associate Planner
Brent Husher, Library Director
Jacob Lehrbach, Water Treatment Operator
Brandi Leos, Human Resources Director
Korin Liebl, Administrative Specialist II
Christine Mackie, Adult Service Librarian

Nicole Madigan, Deputy City Recorder
Michael Osborne, Finance Director
Brandon Pederson, Information
Technology (IT) Analyst I
Emma Sagor, Assistant City Manager
Gabriela Santoyo Gutierrez, Equity &
Inclusion Coordinator
Scott Stauffer, City Recorder
Nicole Tetrick, Library Assistant I
Damian Tucker, Utility Technician I
Jacob White, Utility Technician II
Courtney Wilson, Urban Forester
Eanna Zaya, Engineering Technician I

Mayor Batey called the meeting to order at 6:01 p.m.

1. CALL TO ORDER

A. Pledge of Allegiance.

B. Native Lands Acknowledgment.

2. ANNOUNCEMENTS

Mayor Batey announced upcoming activities, including the 2024 State of the City (SOTC) address, bulky waste pick-up days, Juneteenth and Pride events, restoration events at Elk Rock Island and Minthorn Springs Wetlands, and the Porchfest concert series.

Mayor Batey read a haiku poem.

3. PROCLAMATIONS AND AWARDS

A. Pride Month – Proclamation

Abma, Spoke and Word bookshop owner **Cierra Cook**, and **Husher** remarked on the importance of marking Pride month, remaining vigilant in defending lesbian, gay, bisexual, transgender, queer or questioning, intersex, asexual (LGBTQIA+) rights, and creating a welcoming community. **Mayor Batey** proclaimed June to be Pride Month in Milwaukie.

Councilor Stavenjord remarked on the importance of taking Pride Month action beyond Milwaukie's borders.

B. Juneteenth – Proclamation

Mayor Batey noted the upcoming Juneteenth event and Planning Commission Vice Chair **Josh Freeman** and Milwaukie residents **Miles and Naomi Freeman** remarked on the importance of Juneteenth. **Mayor Batey** proclaimed June 19th to be Juneteenth.

4. SPECIAL REPORTS

A. None Scheduled.

5. COMMUNITY COMMENTS

Mayor Batey reviewed the public comment procedures. **Sagor** provided an update on May 21 comments regarding the maintenance of trees in public right-of-way (ROW).

Madigan, speaking on behalf of the American Federation of State, County, and Municipal Employees (AFSCME) Local 350-5, remarked on the challenges of balancing work and life and asked Council to consider adopting a four-day work week.

Heroux and **Lehrbach**, speaking on behalf of AFSCME 350-5, remarked on the union's collective bargaining requests including increased wages and balancing workloads, and empowering staff to make decisions.

Tucker, speaking on behalf of AFSCME 350-5, read a statement from Administrative Specialist II Emilie Bushlen regarding the challenges of living in Milwaukie on a city salary.

Gale, speaking on behalf of AFSCME 350-5, read a statement from Library Assistant I Nicole Tetrick regarding the cost of healthcare benefits for part-time employees.

Mayor Batey thanked AFSCME members for respectfully addressing Council.

Rodney Smith, Milwaukie resident, expressed solidarity with AFSCME 350-5, and commented on the Oregon Department of Transportation's (ODOT's) response to inquiries about the maintenance of trees in public ROW.

Will Anderson, Councilor-elect, thanked AFSCME members for addressing Council and encouraged Council to work on the budget over the next two years.

6. CONSENT AGENDA

It was moved by Councilor Khosroabadi and seconded by Councilor Abma to approve the Consent Agenda as presented.

A. City Council Meeting Minutes:

1. **May 7, 2024, work session, and**
2. **May 7, 2024, regular session.**

B. Resolution 23-2024: A resolution of the City Council of the City of Milwaukie, Oregon, making appointments to city boards and committees.

C. Resolution 24-2024: A resolution of the City Council of the City of Milwaukie, Oregon, acting as the Local Contract Review Board, authorizing a personal services agreement with Willamette Falls Studios to provide government and public access broadcast services.

D. Resolution 25-2024: A resolution of the City Council of the City of Milwaukie, Oregon, acting as the Local Contract Review Board, authorizing a contract with Moss Adams LLP for financial audit services.

E. ~~A resolution authorizing a purchase order for PetroCard Secondary Fueling System.~~ (removed from the agenda)

F. Resolution 26-2024: A resolution of the City Council of the City of Milwaukie, Oregon, authorizing a collective bargaining agreement with the Milwaukie Police Employees Association (MPEA).

Motion passed with the following vote: Councilors Abma, Khosroabadi, Massey, and Stavenjord and Mayor Batey voting "aye." [5:0]

7. BUSINESS ITEMS

A. None scheduled.

8. PUBLIC HEARING

A. 2025-2026 Consolidated Fee Schedule Adoption – Resolution

Call to Order: **Mayor Batey** called the public hearing on the proposed Consolidated Fee Schedule to order at 6:56 p.m. and announced that the purpose of the hearing was to hear the report, take public comment, and consider adopting the fee schedule.

Conflict of Interest: No Council member declared a conflict of interest.

Staff Presentation: **Osborne** introduced Deeds, the new assistant finance director, and provided an overview of the proposed revised fee schedule noting significant changes.

Correspondence: No correspondence had been received on the topic.

Audience Testimony: No audience member wished to comment on the topic.

Close Public Comment: **It was moved by Councilor Abma and seconded by Council President Massey to close the public comment part of the hearing on the proposed Consolidated Fee Schedule. Motion passed with the following vote: Councilors Khosroabadi, Massey, Stavenjord, and Abma, and Mayor Batey voting “aye.” [5:0]**

Mayor Batey closed the public comment part of the hearing at 7:07 p.m.

Council Discussion: **Councilors Stavenjord and Khosroabadi** expressed interest in discussing fees for mobile homes in the next fiscal year. **Sagor** noted staff’s intention to move to a quarterly fee and budget review cycle in the next year.

Council Decision: **It was moved by Councilor Khosroabadi and seconded by Councilor Stavenjord to approve the resolution revising fees and charges and updating the Consolidated Fee Schedule for fiscal years 2025 and 2026. Motion passed with the following vote: Councilors Khosroabadi, Massey, Stavenjord, and Abma, and Mayor Batey voting “aye.” [5:0]**

Resolution 27-2024:

A RESOLUTION OF THE CITY COUNCIL OF THE CITY OF MILWAUKIE, OREGON, REVISING FEES AND CHARGES AND UPDATING THE CONSOLIDATED FEE SCHEDULE FOR FISCAL YEARS 2025 AND 2026.

B. 2025-2026 State Revenue Sharing Election – Resolutions (2)

Call to Order: **Mayor Batey** called the public hearing on the proposed state revenue sharing election to order at 7:10 p.m. and announced that the purpose of the hearing was to hear the report, take public comment, and consider accepting state revenues.

Conflict of Interest: No Council member declared a conflict of interest.

Staff Presentation: **Osborne** explained that the city was required to elect to receive state shared revenues from the sale of regulated products and certify that the city provided certain services. The group discussed how shared revenues are estimated and if Milwaukie and other cities were planning for the projected decline of gas tax revenue.

Correspondence: No correspondence had been received on the topic.

Audience Testimony: No audience member wished to comment on the topic.

Close Public Comment: It was moved by Council President Massey and seconded by Councilor Stavenjord to close the public comment part of the hearing on the proposed state revenue sharing election. Motion passed with the following vote: Councilors Khosroabadi, Massey, Stavenjord, and Abma, and Mayor Batey voting “aye.” [5:0]

Mayor Batey closed the public comment part of the hearing at 7:16 p.m.

Council Decision: It was moved by Councilor Khosroabadi and seconded by Council President Massey to approve the resolution certifying that the city is eligible in the 2025-2026 biennium to receive state shared revenues because it provided four or more municipal services. Motion passed with the following vote: Councilors Khosroabadi, Massey, Stavenjord, and Abma, and Mayor Batey voting “aye.” [5:0]

Resolution 28-2024:

A RESOLUTION OF THE CITY COUNCIL OF THE CITY OF MILWAUKIE, OREGON, CERTIFYING THAT THE CITY IS ELIGIBLE IN THE 2025-2026 BIENNIUM TO RECEIVE STATE SHARED REVENUES BECAUSE IT PROVIDES FOUR OR MORE MUNICIPAL SERVICES.

It was moved by Councilor Khosroabadi and seconded by Council President Massey to approve the resolution declaring the city’s election to receive state revenue sharing funds (general funds of the state) in the 2025-2026 biennium. Motion passed with the following vote: Councilors Khosroabadi, Massey, Stavenjord, and Abma, and Mayor Batey voting “aye.” [5:0]

Resolution 29-2024:

A RESOLUTION OF THE CITY COUNCIL OF THE CITY OF MILWAUKIE, OREGON, DECLARING THE CITY’S ELECTION TO RECEIVE STATE REVENUE SHARING FUNDS (GENERAL FUNDS OF THE STATE) IN THE 2025-2026 BIENNIUM.

C. 2025-2026 Biennial City Budget and Capital Improvement Plan (CIP) Adoption – Resolution

Call to Order: **Mayor Batey** called the hearing on the budget and CIP to order at 7:18 p.m. and announced that the purpose of the hearing was to hear the report, take comments, and consider adopting the budget and CIP.

Conflict of Interest: No Council member declared a conflict of interest.

Staff Presentation: **Osborne** provided an overview of the budget creation process and reviewed the fiscal challenges the city faces beyond the 2025-2026 biennium.

Correspondence: No correspondence had been received on the topic.

Audience Testimony: No audience member wished to comment on the topic.

Questions from Council to Staff: **Council President Massey** encouraged the public to watch the Budget Committee meetings for further details on the budget and **Osborne** suggested the public contact finance department staff with any questions.

Close Public Comment: It was moved by Council President Massey and seconded by Councilor Abma to close the public comment part of the hearing on the proposed 2025-2026 biennial budget. Motion passed with the following vote: Councilors Khosroabadi, Massey, Stavenjord, and Abma, and Mayor Batey voting “aye.” [5:0]

Mayor Batey closed the public comment part of the hearing at 7:23 p.m.

Council Decision: It was moved by Councilor Khosroabadi and seconded by Councilor Abma to approve the resolution adopting the City of Milwaukie budget and Capital Improvement Plan for the biennium commencing July 1, 2024, making appropriation, levying ad valorem taxes, and classifying levies pursuant to Section 11b, Article XI of the Oregon Constitution. Motion passed with the following vote: Councilors Khosroabadi, Massey, Stavenjord, and Abma, and Mayor Batey voting “aye.” [5:0]

Resolution 30-2024:

A RESOLUTION OF THE CITY COUNCIL OF THE CITY OF MILWAUKIE, OREGON, ADOPTING THE CITY OF MILWAUKIE BUDGET AND CAPITAL IMPROVEMENT PLAN FOR THE BIENNIUM COMMENCING JULY 1, 2024, MAKING APPROPRIATIONS, LEVYING AD VALOREM TAXES, AND CLASSIFYING LEVIES PURSUANT TO SECTION 11b, ARTICLE XI OF THE OREGON CONSTITUTION.

9. COUNCIL REPORTS

Council President Massey reported on recent North Clackamas Watershed Council (NCWC) meetings and projects including the Kellogg Creek Dam removal.

Councilor Stavenjord reported on recent meetings of the Houseless Solutions Coalition and low-income housing developments in Oregon City.

Mayor Batey remarked on low-income housing services opening in Milwaukie, the upcoming 2024 SOTC address, how the City of West Linn’s SOTC address had gone, and how the West Linn City Council structured their goals.

10. ADJOURNMENT

Mayor Batey announced that after the meeting Council would first convene as the Milwaukie Redevelopment Commission (MRC) and would then reconvene as Council to meet in executive session pursuant to Oregon Revised Statute (ORS) 192.660 (2)(h) to consult with counsel concerning the legal rights and duties of a public body with regard to current litigation or litigation likely to be filed.

It was moved by Council President Massey and seconded by Councilor Stavenjord to adjourn the Regular Session. Motion passed with the following vote: Councilors Abma, Khosroabadi, Massey, and Stavenjord and Mayor Batey voting “aye.” [5:0]

Mayor Batey adjourned the meeting at 7:38 p.m.

Respectfully submitted,

 Scott Stauffer, City Recorder

This page intentionally left blank.

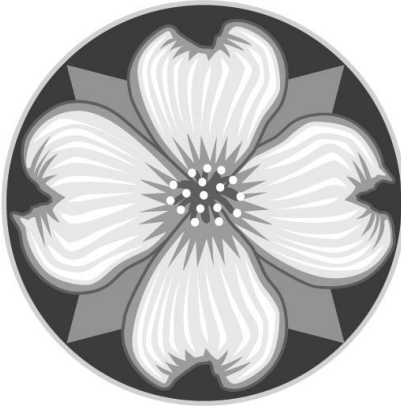

RS Agenda Item

2

Announcements



COMMUNITY EVENT
Saturday, June 15th 2024

4TH ANNUAL

JUNETEENTH CELEBRATION

MILWAUKIE BALL—MICHEL PARK

11AM-3 PM



Mayor's Announcements – June 4, 2024

- **State of the City – Fri., Jun. 7 (4:30 PM)**
 - Join Mayor Lisa Batey to learn more about the city's recent accomplishments and what is to come in 2024 and stay downtown for First Friday.
 - City Hall (Community Room), 10501 SE Main St.
- **First Friday – Fri., Jun. 7 (5-8 PM)**
 - More information at firstfridaymilwaukie.com
- **Curbside Bulky Waste Disposal Event – Sat., June 8 or June 15 (Depending on home address)**
 - For more information contact your hauler or visit milwaukieoregon.gov/bulkywaste
- **Juneteenth Celebration – Sat., Jun. 15 (11 AM – 3 PM)**
 - Celebrate, reflect and amplify Black voices in the city
 - Ball Michel Park, 9781 SE Stanley Ave.
- **Elk Rock Island Volunteer Restoration Event – Sat., Jun. 15 (9:30 AM – 12 PM)**
 - Help remove invasive plants while also picking up litter
 - Meet at 19th and Sparrow at 9:30 a.m.
- **Pride Celebration – Sat., Jun. 29 (10 AM – 12 PM)**
 - Celebrate LGBTQIA+ Pride Month
 - South Downtown Plaza, SE Washington St. and SE Main St.
- **Porchfest – July 12, 19 & 26 – Sign up to be a performer, host, or volunteer**
 - Learn how to get involved at milwaukieporchfest.com
- **LEARN MORE AT WWW.MILWAUKIEOREGON.GOV OR CALL 503-786-7555**

That's too much bacon.

Please bring me some kale chips.

Said no one ever.

- Unknown source

Share your Milwaukie Haiku!

Email yours to bateyl@milwaukieoregon.gov

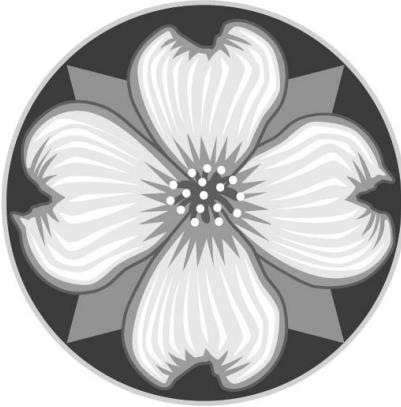

RS Agenda Item

3

Proclamations & Awards

PROCLAMATION

WHEREAS the fight for equality continues for lesbian, gay, bisexual, transgender, queer, questioning, intersex, asexual, and other historically marginalized members of our community (LGBTQIA+), and the responsibility falls on all of us to form a more inclusive and equitable society, and

WHEREAS June 28, 2024, marks the fifty-fifth anniversary of the Stonewall Uprising, six days of demonstrations sparked by the targeting and arrest by police of gay, lesbian, and transgender bar patrons in violation of their civil rights, an event widely recognized as the beginning of the modern gay rights movement, and

WHEREAS history has failed to properly recognize the role of the leaders of the Stonewall Uprising, including Marsha P. Johnson and Sylvia Rivera, transgender women of color who helped spark this movement, and

WHEREAS in 2000, President Bill Clinton declared June to be “Gay & Lesbian Pride Month” to commemorate the Stonewall Uprising, and in 2009, President Barack Obama expanded the commemoration by declaring June to be “Lesbian, Gay, Bisexual, and Transgender Pride Month,” and

WHEREAS despite the progress of recent years, LGBTQIA+ Americans continue to face discrimination and new attacks by state governments and other political figures on the legitimacy of their human rights including their very right to exist.

NOW, THEREFORE, I Lisa Batey, Mayor of the City of Milwaukie, a municipal corporation in the County of Clackamas, in the State of Oregon, do hereby proclaim **JUNE 2024** as **LGBTQIA+ PRIDE MONTH** in Milwaukie in support of our LGBTQIA+ family, friends, and neighbors and to proclaim that love is love, you are valued and welcome, and your city stands with you.

IN WITNESS, WHEREOF, and with the consent of the City Council of the City of Milwaukie, I have hereunto set my hand on this 4th day of June 2024.

Lisa M. Batey, Mayor

ATTEST:

Scott S. Stauffer, City Recorder

PRIDE MONTH
MILWAUKIE

PROCLAMATION

A PROCLAMATION FOR THE COMMEMORATION OF JUNETEENTH AS AN ANNUAL CELEBRATION OF BLACK AFRICAN AMERICAN LIBERATION.

WHEREAS President Abraham Lincoln first issued the Emancipation Proclamation effective January 1st, 1863, declaring enslaved people in the Confederate States to be legally free. However, that proclamation could not be enforced in lands under Confederate control. On April 9th, 1865, Confederate forces surrendered, effectively ending the Civil War. On June 19th, 1865, Union soldiers arrived in Galveston, Texas, the westernmost state of the Confederacy, bringing news of the president's order freeing enslaved people two-and-a-half years after it was first decreed. This day, marking the end of chattel slavery in the United States, has since come to be known as Juneteenth; and

WHEREAS Oregon's Constitutional ban on both slavery as well as residence by free African Americans lay the foundation for generations of economic hardship, exclusion, and discrimination against Oregon's Black African American community; and

WHEREAS through other systems of oppression such as sharecropping, Jim Crow, exclusionary and destructive housing and transportation policies, denial and disruption of voting access, and mass incarceration, the plunder of Black bodies and Black wealth continued past slavery and persists to this day, affecting the physical and mental health, safety, education of and opportunities available to Black African Americans; and

WHEREAS despite these obstacles, Black African Americans in Oregon have been and continue to be dynamic and vital community members and leaders within our state; and

WHEREAS Juneteenth has been celebrated in Oregon since 1945, when Clara Peoples moved to Portland from Oklahoma to work at the Kaiser Shipyards and introduced it to her co-workers; and

WHEREAS the City of Milwaukie, the State of Oregon, and the federal government now recognize Juneteenth as a legal holiday.

NOW, THEREFORE, we, the City Council of the City of Milwaukie, a municipal corporation in the County of Clackamas, in the State of Oregon, do hereby recognize and proclaim **Juneteenth, June 19th**, as an annual celebration of the past, present, and future of Black African American liberation and those who continue the work to realize that liberation.

IN WITNESS, WHEREOF, I have set my hand on this 4th day of **June 2024**.

Lisa Batey, Mayor

ATTEST:

Scott Stauffer, City Recorder

Sources and References:

<https://www.juneteenthor.com>

<https://www.ohs.org/events/oregons-enigmatic-black-history.cfm>

<https://nmaahc.si.edu/blog-post/historical-legacy-juneteenth>

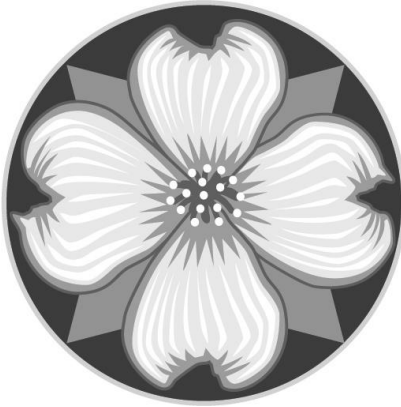

RS Agenda Item

5

Community Comments



**CITY OF MILWAUKIE
CITY COUNCIL**

10722 SE Main Street
P) 503-786-7502
F) 503-653-2444
ocr@milwaukieoregon.gov

Speaker Card

The City of Milwaukie encourages all residents to express their views to their city leaders in a **respectful** and **appropriate** manner. If you wish to speak before the City Council, fill out this card and hand it to the City Recorder. Note that this Speaker Card, once submitted to the City Recorder, becomes part of the public record.

Name: Nicole Madigan

Address: City of Milwaukie/Oak Grove

Organization: Local AFSCME 3505

Phone: Resident

Email: _____

Meeting Date: 6/4/2024 **Topic:** _____

Agenda Item You Wish to Speak to:

- #5 Community Comments**
Note: Council generally does not respond to comments during this meeting. The city manager will respond to comments at the next regular session.
- #7 Other Business, Topic:** _____
- #8 Public Hearing, Topic:** _____

You are Speaking...

- in Support
- in Opposition
- from a Neutral Position
- to ask a Question

Comments:



**CITY OF MILWAUKIE
CITY COUNCIL**

10722 SE Main Street
P) 503-786-7502
F) 503-653-2444
ocr@milwaukieoregon.gov

Speaker Card

The City of Milwaukie encourages all residents to express their views to their city leaders in a **respectful** and **appropriate** manner. If you wish to speak before the City Council, fill out this card and hand it to the City Recorder. Note that this Speaker Card, once submitted to the City Recorder, becomes part of the public record.

Name: Jacob Lehrbach and Adam Heroux

Address: 10301 SE Main St.

Organization: AFSCME 3505

Phone: 971-336-1777

Email:

Meeting Date: 6/4/24 **Topic:** City Council and Union Collaboration

Agenda Item You Wish to Speak to:

#5 Community Comments

Note: Council generally does not respond to comments during this meeting. The city manager will respond to comments at the next regular session.

#7 Other Business, Topic: _____

#8 Public Hearing, Topic: _____

You are Speaking...

in Support

in Opposition

from a Neutral Position

to ask a Question

Comments:

Requesting 10 minute organization slot



**CITY OF MILWAUKIE
CITY COUNCIL**

10722 SE Main Street
P) 503-786-7502
F) 503-653-2444
ocr@milwaukieoregon.gov

Speaker Card

The City of Milwaukie encourages all residents to express their views to their city leaders in a **respectful** and **appropriate** manner. If you wish to speak before the City Council, fill out this card and hand it to the City Recorder. Note that this Speaker Card, once submitted to the City Recorder, becomes part of the public record.

Name: Darrian Tucker

Address:

Organization:

Phone:

Email:

Meeting Date: 6-4-24

Topic: AFSCME Contract

Agenda Item You Wish to Speak to:

#5 Community Comments

Note: Council generally does not respond to comments during this meeting. The city manager will respond to comments at the next regular session.

#7 Other Business, Topic: _____

#8 Public Hearing, Topic: _____

You are Speaking...

in Support

in Opposition

from a Neutral Position

to ask a Question

Comments:

Requesting 3 minutes



**CITY OF MILWAUKIE
CITY COUNCIL**

10722 SE Main Street
P) 503-786-7502
F) 503-653-2444
ocr@milwaukieoregon.gov

Speaker Card

The City of Milwaukie encourages all residents to express their views to their city leaders in a **respectful** and **appropriate** manner. If you wish to speak before the City Council, fill out this card and hand it to the City Recorder. Note that this Speaker Card, once submitted to the City Recorder, becomes part of the public record.

Name: Jessalynn Gale

Address: 2406 SE Monroe

Organization: City of Milwaukie
Leading Library

Phone: 503-504-5527

Email:

Meeting Date: 6/4/24

Topic: AFSCME Contract

Agenda Item You Wish to Speak to:

#5 Community Comments

Note: Council generally does not respond to comments during this meeting. The city manager will respond to comments at the next regular session.

#7 Other Business, Topic: _____

#8 Public Hearing, Topic: _____

You are Speaking...

in Support

in Opposition

from a Neutral Position

to ask a Question

Comments:

Requesting 3 minutes



**CITY OF MILWAUKIE
CITY COUNCIL**

10722 SE Main Street
P) 503-786-7502
F) 503-653-2444
ocr@milwaukieoregon.gov

Speaker Card

The City of Milwaukie encourages all residents to express their views to their city leaders in a **respectful** and **appropriate** manner. If you wish to speak before the City Council, fill out this card and hand it to the City Recorder. Note that this Speaker Card, once submitted to the City Recorder, becomes part of the public record.

Name: Rodney Smith
Organization: _____

Address: _____
Phone: _____
Email: _____
Meeting Date: June 4 **Topic:** Trees on Odot

Agenda Item You Wish to Speak to:

- #5 Community Comments
Note: Council generally does not respond to comments during this meeting. The city manager will respond to comments at the next regular session.
- #7 Other Business, Topic: _____
- #8 Public Hearing, Topic: _____

You are Speaking...

- in Support
- in Opposition
- from a Neutral Position
- to ask a Question

Comments:



**CITY OF MILWAUKIE
CITY COUNCIL**

10722 SE Main Street
P) 503-786-7502
F) 503-653-2444
ocr@milwaukieoregon.gov

Speaker Card

The City of Milwaukie encourages all residents to express their views to their city leaders in a **respectful** and **appropriate** manner. If you wish to speak before the City Council, fill out this card and hand it to the City Recorder. Note that this Speaker Card, once submitted to the City Recorder, becomes part of the public record.

Name: Will Anderson

Address:

Organization:

Phone:

Email:

Meeting Date: _____

Topic: AFSCME

Agenda Item You Wish to Speak to:

#5 Community Comments

Note: Council generally does not respond to comments during this meeting. The city manager will respond to comments at the next regular session.

#7 Other Business, Topic: _____

#8 Public Hearing, Topic: _____

Comments:

You are Speaking...

in Support

in Opposition

from a Neutral Position

to ask a Question

AFSCME 350-5 PUBLIC TESTIMONY BEFORE MILWAUKIE CITY COUNCIL ON JUNE 4, 2024

My name is Adam Heroux and I am the president of AFSCME LOCAL 350–5. I work on the city's Planning team.

Thank you, Mayor Batey , councilor stavenjord,, councilor Khosroabadi, council president massey, councilor abMa... pause and councilor elect will Anderson, congratulations on your election.

I am here tonight with Jacob lehrbach, our locals vice president and many other union members and supporters to tell city council that we know what we are worth and we deserve a fair contract that honors our exceptional commitment to this city.

Our presence here tonight is an invitation for collaboration and for opening a longer term dialogue with Council about how you can better support your workers and how we can better help this city thrive.

Over the last two contracts covering 6 years, our workers lost 6.25% in wages due to low COLAs failing to combat inflation. If you include inflation in 2023 and 2024, our workers are already 14% behind where we were at the start of that six year period—and that's without compounding the inflation.

So far, the city's message to our union has been that workers are going to need to sacrifice , again—take a pay cut, again—for a budget crisis we were told by leadership that “everyone knew was coming.” We provided many ways for the city to meet our needs, but we got told no on virtually every one of our economic proposals. We need bold leaders on City Council who are not afraid to raise revenues and stabilize our city staff and community services, not more of the same old excuses for why we keep falling short.

Milwaukie is hiring for a new City Manager. Our next City Manager must be someone who is willing to take this on, willing to shift our culture, and willing to commit to paying us what we deserve. It is absolutely crucial to the health of our city that our union workers play a major role in deciding who will be bringing their leadership to that important role.

We often hear our managers celebrate our “grit and heart”, our efficiency, how we “do more with less.” It's that “special something” that Milwaukie workers bring to work every day, but there's a darker side to this kind of thinking.

Real “grit and heart” is experienced by your workers as a gut punch — whether it's working late and missing out on family time or the toll it takes working 18 hour shifts in the freezing cold with dangerous equipment and barely enough sleep. The anxiety knots in your stomach when your manager has you doing work you're not qualified to do. The helpless feeling when you are worn down, but the city pays so little that you need a second job to make ends meet. Or you are working part time, and you can't afford to pay 5x more than a full time staff for health insurance, so you go without and risk financial ruin at the hands of our healthcare

system. Or your coworker goes out on leave and the city doesn't find you much help, expecting you to do two jobs for the same pay. Or when your manager denies your request to telework without a reason while your coworkers telework without issues. The problem with grit is that it wears you down to the point where your heart just isn't in it anymore. It's no surprise that we have seen alarming turnover in recent years. More than 1 in 4 of our workers in the bargaining unit started their positions since 2022. And far too many of the staff who started since then, have left or plan to leave. Our median manager tenure even is probably less than 5 years, too, so there has been turnover across the board.

Our Engineering department has been buzzing with overly ambitious construction timelines and development reviews... amid extraordinarily high turnover, our Building office is handling a flood of hundreds of inspections... without the necessary staff to do them, our Planners are constantly scrambling to assess developer proposals and permits for hundreds of units of middle and multi unit housing alongside big long range planning projects, but we can't find funding for economic development programs we have committed to. Our Public Works teams heroically respond to dangerous storms and difficult maintenance issues so that we can all be safe... but the city doesn't pay them all the same rate for the same work, and we open the city for business when it should be closed, putting our staff in unnecessary danger. Our Library staff are on the front lines of public service providing beloved community programs in an often chaotic and flawed environment that makes them a frontline service for people in crisis and the only library in the region that was open during our last winter storm. Our code enforcement team is pounding the pavement to enforce Milwaukie's inundation of code and parking violations due to decisions made above them and our population growth as the city has further developed. And our police records staff are barely treading water under the pressure of supporting our police with several key positions vacant and extremely limited capacity for the last several months. With our move to City Hall, Our administrative staff have been thrown into a totally new environment for engaging with the public, being asked to learn the basic functions of five or six different administrative positions without a pay increase even while training to learn each others jobs.

Milwaukie has taken big strides in recent years despite a global pandemic and housing crisis that make this one of the most expensive regions in the world. But Milwaukie workers have been left behind over and over. It's time to invest in us like we have invested in Milwaukie year after year.

AFSCME 350-5 PUBLIC TESTIMONY BEFORE MILWAUKIE CITY COUNCIL ON JUNE 4, 2024

My name is Jacob Lehrbach and I am AFSCME 350-5's Vice President. I have been here for about six years, currently serving as Water Treatment Operator in Public Works. I was born and raised in Clackamas County and I started my career here at the city as a utility tech 1 and I worked my way up to a Tech 2 and to my current position. Not everyone gets the opportunity to advance like I did and we want all our workers to have that opportunity.

We wouldn't want to leave here tonight without sharing more of our intentions about what we'd like to see change here at the city. Our most critical issue is our declining wages, but there are many other ways we can work together to improve our work culture and make Milwaukie a great place to work. Milwaukie's culture has relied too much on top-down managing and decision making rather than empowering the great leadership potential in our highly skilled and adaptable workers. This needs to change if the city wants to meet the big challenges of our time.

Milwaukie workers support our union—with 97.7% union membership—and we have shown that we know how to work together, too. More than 75% of our unit has participated in crafting our bargaining priorities. We had more than 20 members show up for our first bargaining session, 40 wore green to show support at our last all staff meeting, and another 20 plus members came to witness the city's response to our opening economic offer. Our member meetings routinely draw 30+ engaged members. Our Members are as fired up as ever, and we are united in support of better wages and working conditions. We are organized and we are the experts at what we do.

We know many members who are feeling discouraged with their time here at the city, folks who are considering leaving for better pay and better culture after seeing what the city wants to pay us in our next contract. We don't want to lose any more of my members; We want a shared commitment to improve the culture, pay, and working conditions. We have been losing far too many highly talented workers for far too long and it has cost us dearly. It's time for City Council to step up and ensure that we stabilize our city and our community's services during this critical time of change. We need you all to show us that you respect and value us as much as we respect and value our shared mission as stewards of this great place.

Thank you.

AFSCME 350-5 PUBLIC TESTIMONY BEFORE MILWAUKIE CITY COUNCIL ON JUNE 4, 2024

My name is Damian Alvarado and I am a union member working in the Public Works department. I am reading this testimony on behalf of Emilie Bushlen, one of our administrative staff who works here at City Hall.

City Council,

I would like to start by saying, I love Milwaukie! For 10 years this is where I live, work, play, shop, and where my son now attends school. But it is becoming increasingly harder to do so. I have worked for the city for five and a half years and am now at the top of my pay scale after multiple attempts to grow within the city. After taxes and deductions, I bring home \$3500/ month to support my son and me. I rent a 2 bedroom, 1 bathroom apartment for \$1650 which I feel fortunate to have found in Milwaukie. As much as I would love to live at Henley Place, Axletree or Seven Acres, I can't afford the \$2,200-\$2,600 per month in rent.

Just to quickly summarize my monthly budget:

Take home: \$3500

Rent: \$1650

Car & renters insurance: \$165

Utilities: \$200

Car payment: \$500

Student loan: \$50 (minimum payment)

Gas: \$125

Groceries: \$600

Phone: \$100

Laundry room charges: \$20

This leaves me with \$90 each month for anything extra – school activities, haircuts or any unexpected expense. I couldn't afford childcare if I was lucky enough to find it and am thankful my team works with me to accommodate a schedule that fits both my needs and the city's needs. I am doing everything I can to live as frugally as possible – bringing my own lunch, making my coffee at home, taking advantage of free lunches at school but it's just not cutting it. I am currently looking into second jobs to make ends meet but as a single parent, it's difficult.

I am asking you to show us that we matter, and the way to do that is by giving us the raise we deserve and making it possible to both live and work in our sweet little city.

Thank you for taking the time to listen.

Respectfully,

Emilie Bushlen

My name is Jessalynn Gale and I am a union member working at the Ledding Library. I am reading the following testimony on behalf of another Library staff, Nicole Tetrick.

Hi, my name is Nicole Tetrick and I have worked at the Ledding Library as either an oncall or part time employee for close to 13 years. I love being a part of the Milwaukie community and working for the City. I have some concerns, however, about the cost of healthcare benefits for part time employees here. I think we can agree that healthcare is a very important issue. Every year since I have been eligible to have health care benefits through the city, I look at the cost and try to figure out how it would be feasible financially to access it. The truth is it's still too expensive. For a family of four the cost is currently between \$550-\$600 per month depending on what plan you pick. For a full time employee with the same number of family members the cost is less than \$120 per month. I work 25 hours per week. An employee is considered full time if they work 36 hours per week. There are only a certain number of full time positions available at the library. In the past couple of years there have been three added and one of these I was offered because of my seniority. Part of the problem for me is that there are employees with less seniority than I, that need these benefits and hours more than I do. Yes, I need them too, but I have a spouse that helps provide benefits for me. They aren't great benefits but it is more than having nothing. I would have felt immense guilt over accepting those full time hours. I passed on those hours in part to make sure a person who needed them more than I could have them. It truly is an awful position to be in.

I just don't believe that the gap between what a full time employee pays and a part time employee pays should be so extreme. I work 11 hours less per week than an employee that would be considered full time and I have to pay 5 times the amount that they do for the same insurance plan. I'd like to see the city take on a larger portion of the cost. I think this is the responsible and ethical thing to do.

Thank you very much for your time today.

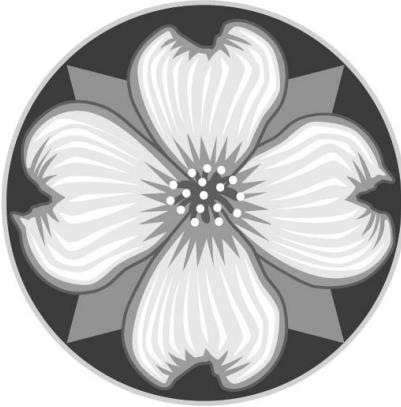

RS Agenda Item

6

Consent Agenda

COUNCIL WORK SESSION

City Hall Council Chambers, 10501 SE Main Street
& Zoom Video Conference (www.milwaukieoregon.gov)

MINUTES

MAY 7, 2024

Council Present: Councilors Shane Abma, Adam Khosroabadi, Rebecca Stavenjord, and Council President Robert Massey, and Mayor Lisa Batey

Staff Present: Joseph Briglio, Acting Assistant City Manager Emma Sagor, Acting City Manager
Jennifer Garbely, City Engineer Scott Stauffer, City Recorder
Justin Gericke, City Attorney Jeff Tolentino, Assistant City Engineer
Josh Neath, Associate Engineer

Mayor Batey called the meeting to order at 4:01 p.m.

1. Safe Access for Everyone (SAFE) and Street Surface Maintenance Program (SSMP) – Annual Report

Garbely reported that staff would be moving this annual report to the fall and provided an overview of the SAFE program. **Tolentino** provided an overview of SSMP, and the pavement condition index (PCI) used to grade roadways. The group discussed SSMP funding and progress in improving collector and side streets PCI.

Councilor Stavenjord arrived at the meeting at 4:08 p.m.

Tolentino reviewed the overall PCI of Milwaukie streets. **Mayor Batey** and **Garbely** noted the city's progress in improving roadways and leveraging other projects to address poor road conditions. The group noted how staff updates the PCI ratings over time.

Garbely provided an overview of integrated SAFE, SSMP, and Americans with Disabilities Act (ADA) projects. The group remarked on how staff leverages elements of projects and prioritizes ADA improvements to complete the most projects possible.

Councilors Abma and Khosroabadi and **Garbely** commented on federal requirements to have an ADA plan and the risk of losing funding for not working to complete the plan.

Garbely provided an update on the Washington Street Area Improvements and the group remarked on how the project had been funded and whether the city undergrounds utility wires as a part of SAFE or SSMP projects.

Tolentino and **Garbely** provided updates on the Ardenwald North, King Road, Harvey Street, and Stanley Avenue improvement projects. The group discussed deadlines to use Safe Routes to Schools (SRTS) funds for the Stanley project and noted a potential lack of funding for the project. There was Council consensus that staff should continue to seek an intergovernmental agreement (IGA) with the county for the Stanley project.

Garbely noted the status of the Monroe Greenway project and **Mayor Batey** reported there would be renewed childcare activity at the site of the former Young Men's Christian Association (YMCA) site at Hwy 224 and Monroe Street.

Garbely reported on the status of the 2024 SSMP slurry seal project, noted where the city was in using the second tranche of SAFE bond fundings, and asked for Council feedback on seeking a third tranche of bond funds. **Sagor** and **Garbely** reviewed the list of projects slated for completion in the third tranche.

Council discussed whether to proceed with a third tranche of SAFE program funding, with **Mayor Batey**, **Council President Massey**, and **Councilors Stavenjord and Khosroabadi** suggesting Council needed more information before they could decide on further bond funding. **Garbely** and **Sagor** suggested Council would need to discuss and decide about a third tranche of bond funding within the next year.

Sagor summarized that Council would revisit bond funding later in 2024 and in 2025.

Garbely reported that staff would be seeking grant funding for a Harrison Street / 42nd Avenue / King Road crash corridor study. The group commented on whether it would be feasible and desirable to install a roundabout on King Road.

2. Neighborhood Greenway Strategies – Update

Garbely and **Neath** provided an update on plans to improve the 29th Avenue Greenway, noting three-phases beginning with the installation of signs. **Councilor Stavenjord**, **Neath**, and **Garbely** commented on neighborhood response to the proposed plan and how the plan for 29th Avenue could inform improvements on other greenways.

Neath explained that phase two, the installation of pavement markers, would occur after slurry seal work is done this summer. **Garbely** noted the plan includes markers for bicycle and pedestrian crossings on one side of the road and **Councilor Stavenjord** wondered whether bikers and walkers cross the street to use such markers.

Neath reported that phase three would include additional pavement markers that are part of the Ardenwald North project and noted neighborhood district association (NDA) meetings and engagement activities staff had done for the project.

The group discussed the location and style of signs to be installed in phase one. **Garbely** noted the neighborhood's request for a slower speed limit on the greenway and that staff would consider the request through the Transportation System Plan (TSP) update.

Mayor Batey supported slower speed limits on greenways and the group remarked on how to establish a process for lowering greenway speed limits. **Garbely** and **Sagor** explained concerns about adding to staff workload and administering other projects.

Councilor Stavenjord asked about contracting with other cities to increase staff capacity to take on processes. **Sagor** said staff would look at workload options.

Mayor Batey and **Garbely** noted that the staff proposal for the TSP would be to lower all greenway speeds to 20 miles per hour. **Council President Massey** and **Garbely** noted that lowering the speed limit does not necessarily lead to vehicles going slower and the group noted the possibility of asking other cities for data about lowered speed limits.

Garbely reviewed the budget and outreach strategy for the 29th Avenue Greenway plan. **Sagor** noted that Council didn't need to authorize funds for the greenway.

The group reviewed the designs for the greenway signs.

3. Adjourn

Mayor Batey adjourned the meeting at 5:33 p.m.

Respectfully submitted,

Scott Stauffer, City Recorder

COUNCIL REGULAR SESSION

City Hall Council Chambers, 10501 SE Main Street
& Zoom Video Conference (www.milwaukieoregon.gov)

MINUTES

MAY 7, 2024

Council Present: Councilors Shane Abma, Adam Khosroabadi, Rebecca Stavenjord, and Council President Robert Massey, and Mayor Lisa Batey

Staff Present: Joseph Briglio, Acting Assistant City Manager
Tony Cereghino, Police Captain
Justin Gericke, City Attorney
Millie the Goose, City Mascot
Adam Heroux, Associate Planner
Vera Kolas, Senior Planner
Brandi Leos, Human Resources Director

Nicole Madigan, Deputy City Recorder
Emma Sagor, Acting City Manager
Scott Stauffer, City Recorder
Jason Wachs, Community Engagement
Coordinator
Laura Weigel, Planning Manager

Mayor Batey called the meeting to order at 6:03 p.m.

1. CALL TO ORDER

A. Pledge of Allegiance.

B. Native Lands Acknowledgment.

2. ANNOUNCEMENTS

Mayor Batey announced upcoming activities including neighborhood district association (NDA) elections, the Friends of the Ledding Library (FOLL) annual plant sale, an open house at Minthorn Springs, the Corporal Diffie Veterans Fund (CDVF) pancake fundraiser, a bioblitz event at Kellogg Creek, and the Kellogg Creek Water Recovery Facilities' 50th anniversary celebration.

Mayor Batey read a haiku about Minthorn Springs wildlife.

3. PROCLAMATIONS AND AWARDS**A. 2023 Volunteer of the Year Presentation – Award**

Wachs and **Mayor Batey** introduced Volunteer of the Year Samantha Swindler. Council congratulated Swindler and **Swindler** remarked on the importance of volunteering.

B. Mental Health Awareness Month - Proclamation

Cereghino introduced the National Alliance on Mental Illness (NAMI) Clackamas executive director Dave Hunt. **Hunt** commented on mental health issues and the center's work. **Mayor Batey** proclaimed May to be Mental Health Awareness Month in Milwaukie.

C. National Law Enforcement Week – Proclamation

Cereghino commented on sacrifices made by law enforcement professionals and **Mayor Batey** proclaimed May 12-18, 2024, to be National Law Enforcement Week in Milwaukie.

D. Public Service Recognition Week – Proclamation

Mayor Batey commented on the importance of public service and proclaimed May 5-11, 2024, to be Public Service Recognition Week in Milwaukie.

4. SPECIAL REPORTS

A. Hillside Park and Scattered Sites Relocation – Update

Briglio introduced **Adam Brown**, Clackamas County Health, Housing, and Human Services (H3S), and **Devin Ellin**, Housing Authority of Clackamas County (HACC).

Brown provided an update on the county's work to reposition and expand public housing facilities across the county. **Ellin** reported on the Hillside Park redevelopment project, noting upcoming construction and the phased approach to relocate current residents.

Councilor Abma and **Ellin** noted that phase 1 of the Hillside project was scheduled to be complete in 2026 and phase 2 would begin soon.

Mayor Batey and **Ellin** noted how many people would live onsite during the Hillside construction and how a housing voucher works. **Brown** and **Ellin** remarked on the challenges of relocating families and noted the county's work to support the residents.

Councilor Khosroabadi and **Ellin** remarked on the impact of moving on children, noting that HACC tries to relocate students within the same school district. **Brown** suggested county staff would check with moved families to confirm schooling had been addressed.

Councilor Stavenjord asked about HACC's partnership with the North Clackamas School District (NCSD). **Brown** noted county staff would follow-up on the NCSD partnership and **Stavenjord** offered to help connect the county and school district.

Councilor Stavenjord and **Ellin** discussed the county's housing waitlist and whether housing vouchers were adjusted to match the household size.

Councilor Abma thanked the county staff and Councilor Stavenjord for their work on housing and **Ellin** thanked the city for working on affordable housing. **Mayor Batey** noted the housing advocacy work of former Council members.

Mayor Batey and **Ellin** discussed the county's process for supporting Hillside residents to become property owners. They noted the timeline for some residents to be relocated.

Councilor Khosroabadi, **Ellin**, and **Brown** remarked on whether Hillside residents had experienced discrimination and the county's work to place families in housing.

Councilor Stavenjord and **Brown** remarked on the number of scattered housing sites in and near Milwaukie and how the city can remain involved in the scattered sites discussion.

Mayor Batey and **Brown** noted the status of the county's new behavioral health clinics.

5. COMMUNITY COMMENTS

Mayor Batey reviewed the comment procedures. **Sagor** reported on staff responses to comments submitted since the last regular session, including questions about broadband internet, downtown residential parking, and a proposed proclamation addressing the Israeli-Palestinian conflict. No audience member wished to speak to Council.

6. CONSENT AGENDA

It was moved by Councilor Khosroabadi and seconded by Councilor Abma to approve the Consent Agenda as revised.

~~A. City Council Meeting Minutes: (removed from the agenda)~~

- ~~1. April 2, 2024, work session, and~~
- ~~2. April 2, 2024, regular session.~~

- B. **Resolution 17-2024:** A resolution of the City Council of the City of Milwaukie, Oregon, making an appointment to the Transportation System Plan Advisory Committee (TSPAC).
- C. **Resolution 18-2024:** A resolution of the City Council of the City of Milwaukie, Oregon, acting as the Local Contract Review Board, authorizing the city manager to execute a contract amendment for municipal court judge services.
- D. **Resolution 19-2024:** A resolution of the City Council of the City of Milwaukie, Oregon, acting as the Local Contract Review Board, approving the award of a contract for construction of 2024 grind and pave project to Eagle Elsner Inc.

Motion passed with the following vote: Councilors Abma, Khosroabadi, Massey, and Stavenjord and Mayor Batey voting “aye.” [5:0]

7. BUSINESS ITEMS

A. Youth Board and Committee (BC) Member Appointments – Resolution

Madigan provided an overview of the youth BC member program history and recruitment and explained that Council was asked to adopt a resolution making new youth BC member appointments.

Councilor Stavenjord welcomed the youth nominees who were present, including Stella Stastny, Avree Hayes, and Harper Paramchuk. **Stastny, Hayes, and Paramchuk** introduced themselves and Council and Millie welcomed the new youth BC appointees.

It was moved by Councilor Stavenjord and seconded by Council President Massey to approve the resolution making youth board and committee member appointments. Motion passed with the following vote: Councilors Abma, Khosroabadi, Massey, and Stavenjord and Mayor Batey voting “aye.” [5:0]

Resolution 20-2024:

A RESOLUTION OF THE CITY COUNCIL OF THE CITY OF MILWAUKIE, OREGON, MAKING YOUTH BOARD AND COMMITTEE MEMBER APPOINTMENTS.

B. City Manager Recruitment Materials – Motion

Leos and Heather Gantz, senior manager with Raftelis, presented the recruitment materials for the city manager position. The group reviewed the materials and discussed how to word the Charter requirement that the city manager live in city limits. It was Council consensus to leave the residency requirement as presented.

It was moved by Councilor Khosroabadi and seconded by Councilor Stavenjord to approve the city manager recruitment materials. Motion passed with the following vote: Councilors Abma, Khosroabadi, Massey, and Stavenjord and Mayor Batey voting “aye.” [5:0]

Mayor Batey recessed the meeting at 7:56 p.m. and reconvened at 8:06 p.m.

8. PUBLIC HEARING

A. Neighborhood Hubs Adoption – Ordinance

Call to Order: Mayor Batey called the public hearing on the proposed neighborhood hubs code adoption, to order at 8:06 p.m.

Purpose: Mayor Batey announced that the purpose of the hearing was to hear the staff report and take public comment on the proposed code amendments.

Conflict of Interest: No Council member declared a conflict of interest.

Staff Presentation: **Kolias** and **Heroux** provided an overview of the proposed neighborhood hubs code, noting how the code had been created, the community engagement work done by staff, the inclusion of hubs in the Comprehensive Plan, and reporting that the changes had received support from the neighborhoods. They reviewed what the hubs code would do to support the development of hubs, the placemaking criteria that would be used to define the hubs and noted the identified hub locations.

Mayor Batey and **Heroux** noted the potential impacts of the North Clackamas School District (NCS D) activating the Hector Campbell School site on potential hub activity.

Kolias presented and explained the proposed hubs code changes, including rezoned areas on 42nd Avenue, 22nd Avenue, Harmony Road, 32nd Avenue, Lake Road, and Monroe Street. The public notices, comments received, Planning Commission recommendation, and Council options were noted.

Correspondence: Staff reported that an email from Zack and Jacquie Foss, Milwaukie residents, had been received.

Council Questions to Staff:

Councilor Khosroabadi asked for clarification about building heights in hub areas and **Kolias** explained that permitted office uses would be allowed on lots of the right size.

Mayor Batey and **Kolias** discussed how the proposed code defined “temporary”, whether marijuana retailers, bars, certain repair shops, and manufacturing businesses could be in a hub, and why a location at 37th Avenue and Monroe Street had been called out in the code. They also noted what type of signs would be allowed in the hub areas and when the hubs code would take effect once adopted.

Audience Testimony:

Douglas Leitz, Milwaukie Floral owner, spoke from a neutral position and remarked on how the zone change could impact the Milwaukie Floral property, and suggested more time was needed for business owners to assess the effects of the proposed code.

Loretta Sharpe, Milwaukie resident, opposed the proposed hubs code citing concern about increased traffic and a tall apartment building being built on 32nd Avenue.

Staff Response to Testimony: **Kolias** clarified that if hub zone changes were made, that zoning could be changed again later through a rezone process and that a new apartment building would need a conditional use approval from the Planning Commission.

Council Questions to Staff: **Councilors Abma and Stavenjord** and **Kolias** clarified the rezoning process steps and that pre-existing non-conforming uses, such as Milwaukie Floral, could continue to operate on rezoned properties or if the property were sold.

Mayor Batey suggested Council was leaning toward continuing the hearing to give the public more time to consider the proposed code changes. **Council President Massey** supported continuing the hearing and suggested there were issues for Council to note for staff to bring back at the continued hearing.

Close Public Comment: **It was moved by Councilor Khosroabadi and seconded by Council President Massey to close the public testimony part of the neighborhood hubs code adoption hearing. Motion passed with the following vote: Councilors Abma, Khosroabadi, Massey, Stavenjord, and Mayor Batey voting “aye.” [5:0]**

Mayor Batey closed the public comment part of the hearing at 9:08 p.m.

Council Decision: **Mayor Batey** noted that it was Council consensus to continue the hearing a date to be determined by staff.

The group discussed issues for staff to provide responses to at the next hearing, including the types of commercial and mixed-use zone uses that would be allowed in a hub, how specific the code could be in not allowing certain commercial uses, what commercial uses are considered administrative service use.

Councilor Stavenjord suggested Council wanted the hubs code to help ensure that the right scale of commercial activity is developed in the hub areas, observing that the city probably couldn't dictate the types of offices that would be allowed.

Weigel reported that staff would take Council's feedback into consideration and revisit the proposed hub zoning changes. The group discussed the process steps that would need to be redone, and the time those steps take, if the Council directed that other zone changes were to be made that go beyond what had been proposed. It was Council consensus that staff would only look at changes to the proposed code and zone changes.

Sagor summarized that Council should continue the hearing to July 16 and staff would work to respond to Council's noted issues. **Mayor Batey** agreed with Sagor and observed that the city could be set up for land use conflicts in the new code without having reasonable commercial hours of operation limitations in the new code. **Council President Massey, Kolia, and Weigel** noted that revisiting hours of operation would not expand the code changes beyond the proposed changes.

Council remarked on how much commercial activity and the kind of activities the city wanted to encourage in the hub areas.

Councilor Stavenjord and **Council President Massey** suggested staff had enough feedback and the group discussed the process to continue the hearing.

It was moved by Councilor Abma and seconded by Councilor Khosroabadi to continue the hearing on the Neighborhood Hubs Adoption (File #ZA-2024-001) to a date certain of July 16, 2024. Motion passed with the following vote: Councilors Abma, Khosroabadi, Massey, and Stavenjord and Mayor Batey voting "aye." [5:0]

9. COUNCIL REPORTS

None.

10. ADJOURNMENT

Mayor Batey announced that Council would meet in executive session pursuant to Oregon Revised Statute (ORS) 192.660 (2)(d) to conduct deliberations with persons designated by the governing body to carry on labor negotiations.

It was moved by Council President Massey and seconded by Councilor Abma to adjourn the Regular Session. Motion passed with the following vote: Councilors Abma, Khosroabadi, Massey, and Stavenjord and Mayor Batey voting "aye." [5:0]

Mayor Batey adjourned the meeting at 9:56 p.m.

Respectfully submitted,

Scott Stauffer, City Recorder

COUNCIL STAFF REPORT

To: Mayor and City Council
Emma Sagor, Acting City Manager

Date Written: May 23, 2024

Reviewed: Scott Stauffer, City Recorder

From: Nicole Madigan, Deputy City Recorder

Subject: **Appointments & Reappointments to City Boards and Committees**

ACTION REQUESTED

As outlined in the Milwaukie Municipal Code (MMC), Council is asked to consider approving a resolution making appointments and reappointments to city boards and committees (BCs).

HISTORY OF PRIOR ACTIONS AND DISCUSSIONS

All individuals recommended for appointment have been nominated by interview panels consisting of members of Council, the BC's staff liaisons, and BC representatives – except the Planning Commission nomination which was submitted by the Mayor as authorized in the MMC.

Those listed below for reappointment were previously appointed by Council to the BC positions they currently hold. In recent years, it has been Council's policy to reappoint BC members if they are eligible for another term and are interested in continuing to serve.

ANALYSIS

Authority to fill city BC vacancies is granted to the Mayor and Council by Section 26 of the City Charter. To fill vacant positions, members of Council, and appropriate staff liaisons and BC chairs, conduct interviews from applications received by the city. The interview panel makes appointment recommendations to Council, which considers and typically approves recommendations through the regular session consent agenda. Appointed individuals serve for a term length determined by the MMC. Upon the completion of a term, if the individual is eligible, they may be reappointed by Council to serve another term.

BC appointments are made when a term has expired or when a position has been vacated. BC terms expire on June 30, but appointments are also made as needed to fill vacancies. Some BCs have positions nominated by neighborhood district associations (NDAs) instead of by an interview panel. NDA-nominated appointments are noted with ^.

All BC positions are term limited, meaning there is a limit to the number of times that members can be re-appointed. Of the 28 recommended appointments below, eight are being reappointed to their current position for the first time (noted with a single *), four have been reappointed once before (noted with two **), and four have been reappointed twice before (noted with three ***). Several individuals being appointed for a third time began their service in a "zero" term, meaning their first term was not complete and had been started before they were appointed. Per the city's customary practice, zero terms are not counted for the purposes of term limits.

BUDGET IMPACT

It is vital for the city to have functional BCs that reflect the community it supports. By making the proposed appointments, Council is helping to ensure that the BCs can continue that vital work. The proposed BC appointments have no financial impact, however certain BCs have authority to make fiscal decisions recommendations.

CLIMATE IMPACT

Making appointments to BCs such as the Park and Recreation Board (PARB), Public Safety Advisory Committee (PSAC), and the Tree Board ensure we have robust representation of community voices that will help to shape and meet Milwaukie's climate goals.

EQUITY IMPACT

Staff strive to make participation with the city's BCs as accessible as possible by holding hybrid meetings and offering BC applications translated into other languages. The recommended BC appointments would help the city achieve its goal of providing a diverse spectrum of voices. The nominated individuals bring experience and expertise to each of their nominated positions.

WORKLOAD IMPACT

By holding an annual recruitment process, staff can dedicate less time throughout the year to arranging interviews and BCs can continue work uninterrupted.

COORDINATION, CONCURRENCE, OR DISSENT

The office of the city recorder (OCR) worked with BC staff liaisons to confirm that the individuals listed below would like to continue serving in their current BC positions.

STAFF RECOMMENDATION

Staff recommends making the following appointments:

Arts Committee: two-year terms, limit of three consecutive terms.

Position	Name	Term Start Date	Term End Date
4	Sarah McCoy*	7/1/2024	6/30/2026
5	Benjamin Dewey	7/1/2024	6/30/2026
9	Hamid Shibata Bennett*	7/1/2024	6/30/2026
10	Gabriella Ugarte**	7/1/2024	6/30/2026

Audit Committee: two-year terms, limit of three consecutive terms.

Position	Name	Term Start Date	Term End Date
2	Mona Henry**	7/1/2024	6/30/2026
5	Matthew Dake**	7/1/2024	6/30/2026

Budget Committee/Citizens Utility Advisory Board (CUAB): four-year terms, limit of two consecutive terms.

Position	Name	Term Start Date	Term End Date
5	David Chitsazan*	7/1/2024	06/30/2028

Equity Steering Committee (ESC): two-year terms, limit of three consecutive terms.

Position	Name	Term Start Date	Term End Date
6	Seyona Belai*	7/1/2024	6/30/2026
7	Roberto Arreola Moreno	7/1/2024	6/30/2026
8	Aneesa Turbovsky*	7/1/2024	6/30/2026
9	Corey Hester*	7/1/2024	6/30/2026
10	Shayna Justus	7/1/2024	6/30/2026

Note: Position 10 is a new seat being added to the ESC with this appointment. The MMC allows for the ESC to be up to 11 positions; to date it has had 9 positions.

Library Board: two-year terms, limit of three consecutive terms.

Position	Name	Term Start Date	Term End Date
2	Joel McLemore*	7/1/2024	6/30/2026
3	Karla Branson***	7/1/2024	6/30/2026
6	Ann Heiliger***	7/1/2024	6/30/2026

Park and Recreation Board (PARB): two-year terms, limit of three consecutive terms.

Position	Name	Term Start Date	Term End Date
3	Laura Jenks	7/1/2024	6/30/2026

Planning Commission: four-year terms, limit of two consecutive terms.

Position	Name	Term Start Date	Term End Date
2	Leesa Gratreak	7/1/2024	6/30/2026
5	Joshua Freeman*	7/1/2024	6/30/2028
7	Jacob Sherman*	7/1/2024	6/30/2028

Public Safety Advisory Committee (PSAC): two-year terms, limit of three consecutive terms for at-large members, no term limit for NDA representatives.

Position	Name	Term Start Date	Term End Date
1	Rachel Burlington	7/1/2023	6/30/2025
2	Stephan Lashbrook^	7/1/2024	6/30/2026
3	Christine Giatti^	7/1/2024	6/30/2026
4	Camden Mckone	7/1/2024	6/30/2026
7	Elvis Clark^	7/1/2024	6/30/2026
10	John Hudson	7/1/2024	6/30/2026
11	Christina Cole***	7/1/2024	6/30/2026

Tree Board: three-year terms, limit of three consecutive terms.

Position	Name	Term Start Date	Term End Date
1	Kathleen Brennan-Hunter**	7/1/2024	6/30/2027
2	Ley Garnett***	7/1/2024	6/30/2027

ALTERNATIVES

Council could decline to make the recommended appointments, which would result in vacancies on the noted boards and committees.

ATTACHMENTS

1. Resolution

COUNCIL RESOLUTION No.
A RESOLUTION OF THE CITY COUNCIL OF THE CITY OF MILWAUKIE, OREGON, MAKING APPOINTMENTS TO CITY BOARDS AND COMMITTEES.

WHEREAS Milwaukie Charter Section 26 authorizes the Mayor, with the consent of the Council, to make appointments to boards and committees (BCs), and

WHEREAS a few BC positions are currently vacant and many BC terms will expire on June 30, 2024, and

WHEREAS the individuals named below currently serve on city BCs and have expressed interest in continuing to serve or are new nominees and are eligible to serve, and

WHEREAS staff recommends the following qualified individuals be appointed.

Arts Committee:

Position	Name	Term Start Date	Term End Date
4	Sarah McCoy	7/1/2024	6/30/2026
5	Benjamin Dewey	7/1/2024	6/30/2026
9	Hamid Shibata Bennett	7/1/2024	6/30/2026
10	Gabriella Ugarte	7/1/2024	6/30/2026

Audit Committee:

Position	Name	Term Start Date	Term End Date
2	Mona Henry	7/1/2024	6/30/2026
5	Matthew Dake	7/1/2024	6/30/2026

Budget Committee/Citizens Utility Advisory Board (CUAB):

Position	Name	Term Start Date	Term End Date
5	David Chitsazan	7/1/2024	06/30/2028

Equity Steering Committee (ESC):

Position	Name	Term Start Date	Term End Date
6	Seyona Belai	7/1/2024	6/30/2026
7	Roberto Arreola Moreno	7/1/2024	6/30/2026
8	Aneesa Turbovsky	7/1/2024	6/30/2026
9	Corey Hester	7/1/2024	6/30/2026
10	Shayna Justus	7/1/2024	6/30/2026

Library Board:

Position	Name	Term Start Date	Term End Date
2	Joel McLemore	7/1/2024	6/30/2026
3	Karla Branson	7/1/2024	6/30/2026
6	Ann Heiliger	7/1/2024	6/30/2026

Park and Recreation Board (PARB):

Position	Name	Term Start Date	Term End Date
3	Laura Jenks	7/1/2024	6/30/2026

Planning Commission:

Position	Name	Term Start Date	Term End Date
2	Leesa Gratreak	7/1/2024	6/30/2026
5	Joshua Freeman	7/1/2024	6/30/2028
7	Jacob Sherman	7/1/2024	6/30/2028

Public Safety Advisory Committee (PSAC):

Position	Name	Term Start Date	Term End Date
1	Rachel Burlington	7/1/2023	6/30/2025
2	Stephan Lashbrook	7/1/2024	6/30/2026
3	Christine Giatti	7/1/2024	6/30/2026
4	Camden Mckone	7/1/2024	6/30/2026
7	Elvis Clark	7/1/2024	6/30/2026
10	John Hudson	7/1/2024	6/30/2026
11	Christina Cole	7/1/2024	6/30/2026

Tree Board:

Position	Name	Term Start Date	Term End Date
1	Kathleen Brennan-Hunter	7/1/2024	6/30/2027
2	Ley Garnett	7/1/2024	6/30/2027

Now, Therefore, be it Resolved by the City Council of the City of Milwaukie, Oregon, that the individuals named in this resolution are appointed to the identified boards and committees of the City of Milwaukie for the term dates noted.

Introduced and adopted by the City Council on **June 4, 2024**.

This resolution is effective immediately.

ATTEST:

Mark F. Gamba, Mayor

APPROVED AS TO FORM:

Scott S. Stauffer, City Recorder

Justin D. Gericke, City Attorney

COUNCIL STAFF REPORT

To: Mayor and City Council
Emma Sagor, Acting City Manager

Date Written: May 23, 2024

Reviewed: Nicole Madigan, Deputy City Recorder, and
Kelli Tucker, Accounting and Contracts Specialist

From: Scott Stauffer, City Recorder

Subject: **Contract Authorization for Broadcast Services**

ACTION REQUESTED

Council is asked to authorize the city manager to sign a contract with Willamette Falls Studios (WFS) for government and public access broadcast services.

HISTORY OF PRIOR ACTIONS AND DISCUSSIONS

Since 2004, the city has worked with WFS for cable studio access, cablecast programming, and audio/visual (AV) support services. WFS operates a studio in Oregon City and coordinates programming for the city on Comcast cable channel 30 (government access) which broadcasts within city limits.

In 2013 and 2018, following formal solicitation processes, the city entered contracts with WFS for broadcast services when WFS was the only respondent. Both contracts were extended to their maximum allowed term length, the most recent of which is set to expire on June 30, 2024.

In April 2024, as required by the city's Public Contracting Rules (PCR), the city conducted a new formal competitive solicitation process for broadcast services. WFS was once again the only organization to respond to this solicitation. A staff panel reviewed WFS' proposal and unanimously agreed that the city should negotiate a new contract with WFS.

ANALYSIS

The city has enjoyed a good working relationship with WFS' leadership and AV technicians for two decades. The regularly scheduled and on-demand technical support provided by WFS has been invaluable and enabled the city to successfully navigate the challenging circumstances of holding public meetings during a global pandemic. WFS' expertise was also critical in building the best possible broadcast capabilities in chambers at new city hall.

WFS has proposed rates for up to five monthly city meetings and public studio access for the initial five years of the contract term (see table below). Any additional broadcast and AV services will be provided to the city at a separate fee. As to be expected, the fees and charges for these services will increase over time but staff find the requested rate increases to be on par with market-wide inflationary increases and have made appropriate budgetary plans to cover these expenses.

Proposed Budget

Fiscal Year 2024/25		
PROGRAM AREA-Schedule B	MONTHLY AMOUNT	BUDGET AMOUNT
Public Access Operation	\$3,291.00	\$39,492
Government Access Operation	\$3,291.00	\$39,492
	\$6,582.00	\$78,984

Fiscal Year 2025/26		
PROGRAM AREA	MONTHLY AMOUNT	BUDGET AMOUNT
Public Access Operation	\$3,422.50	\$41,070
Government Access Operation	\$3,422.50	\$41,070
	\$6,845.00	\$82,140

Fiscal Year 2026/27		
PROGRAM AREA	MONTHLY AMOUNT	BUDGET AMOUNT
Public Access Operation	\$3,559.50	\$42,714
Government Access Operation	\$3,559.50	\$42,714
	\$7,119.00	\$85,428

Fiscal Year 2027/28		
PROGRAM AREA	MONTHLY AMOUNT	BUDGET AMOUNT
Public Access Operation	\$3,685.00	\$44,220
Government Access Operation	\$3,685.00	\$44,220
	\$7370.00	\$88,440

Fiscal Year 2028/29		
PROGRAM AREA	MONTHLY AMOUNT	BUDGET AMOUNT
Public Access Operation	\$3,850.00	\$46,200
Government Access Operation	\$3,850.00	\$46,200
	\$7,700.00	\$92,400

The new contract with WFS will be for an initial five years, with the city reserving the option to extend it for an additional five years, for a total of up to ten years.

BUDGET IMPACT

The contract includes fees for the initial five fiscal years. The budget for the first two fiscal years (2025-2026) is anticipated to not exceed \$161,124 for monthly broadcast services and public studio access, and the initial five-year term not exceeding \$427,392. Broadcast services are included in the Council’s budget and the proposed 2025-2026 biennial budget has enough funds to cover the cost of the first two fiscal years; subsequent years will be budgeted for accordingly.

CLIMATE IMPACT

Part of the ongoing dialogue between the city and WFS has been about how to provide broadcast and AV services in the most efficient and responsible manner possible. Researching and investing in AV equipment that will have a long lifespan with as minimal environmental impact as possible will remain the goal of the city and WFS.

EQUITY IMPACT

The primary reason for investing in broadcast services is to ensure that the city’s public meetings meet state requirements for accessibility and transparency. By continuing to provide these services, the city is working to ensure that all Milwaukie community members have access to their local government’s business and discussions. WFS has been a great partner in working

to make sure all reasonable Americans with Disabilities Act accommodations can be provided to meeting and public event attendees.

WORKLOAD IMPACT

Staff do not anticipate any new work resulting from the new contract.

COORDINATION, CONCURRENCE, OR DISSENT

The Office of the City Recorder worked with the city manager’s office and the finance and planning departments to conduct the solicitation and review the submitted proposal.

STAFF RECOMMENDATION

Staff recommends that Council authorize the contract for government and public access broadcast services with WFS.

ALTERNATIVES

Council could decline to authorize the contract which would result in the city not having a broadcast services provider as of July 1, 2024. A new formal competitive procurement would then be required to select a provider.

ATTACHMENTS

1. Resolution

COUNCIL RESOLUTION No.

A RESOLUTION OF THE CITY COUNCIL OF THE CITY OF MILWAUKIE, OREGON, ACTING AS THE LOCAL CONTRACT REVIEW BOARD, AUTHORIZING A PERSONAL SERVICES AGREEMENT WITH WILLAMETTE FALLS STUDIOS TO PROVIDE GOVERNMENT AND PUBLIC ACCESS BROADCAST SERVICES.

WHEREAS the city requires government and public access broadcast infrastructure and personnel to provide to record and broadcast public meetings and events; and

WHEREAS the city's current contract Willamette Falls Studios (WFS) for broadcast services ends June 30, 2024, and a formal competitive solicitation was required to enter into a new contract for services; and

WHEREAS WFS was the only responsive and responsible proposer to the city's formal solicitation to provide government and public access broadcast services; and

WHEREAS the city has determined that WFS continues to provide quality and unmatched broadcast services to the city.

Now, Therefore, be it Resolved by the City Council of the City of Milwaukie, Oregon, that the acting city manager or designee is authorized to execute a personal services agreement, including any renewal terms, with Willamette Falls Studios to provide government and public access broadcast services for the City of Milwaukie and its community members.

Introduced and adopted by the City Council on **June 4, 2024**.

This resolution is effective immediately.

Lisa M. Batey, Mayor

ATTEST:

APPROVED AS TO FORM:

Scott S. Stauffer, City Recorder

Justin D. Gericke, City Attorney

COUNCIL STAFF REPORT

To: Mayor and City Council
Emma Sagor, Acting City Manager

Reviewed: Kelli Tucker, Accounting & Contracts Specialist

From: Michael Osborne, Finance Director

Subject: **Authorization of Audit Services Contract**

Date Written: May 22, 2024

ACTION REQUESTED

Council is asked to adopt a resolution authorizing the acting city manager to sign a personal services agreement with Moss Adams LLP for financial audit services for fiscal years 2024-2028.

HISTORY OF PRIOR ACTIONS AND DISCUSSIONS

April 2022: Staff issued a formal competitive solicitation to select a new audit firm.

June 7, 2022: Council adopted [Resolution 37-2022](#) authorizing execution of a contract with Aldrich CPAs + Advisors LLP for audit services beginning with fiscal year 2022.

March 2024: Staff terminated the contract with Aldrich CPAs + Advisors LLP and issued a formal competitive solicitation to select a new audit firm.

ANALYSIS

Oregon Revised Statute (ORS) Chapter 297 requires local governments to file annual financial reports with the Oregon Secretary of State's Audit Division. The annual financial report is required to be audited by independent auditors registered with the Oregon Board of Accountancy. The independent auditor must conduct an audit to an extent satisfactory to the Secretary of State, prepare the independent auditor's report, and express an opinion on the financial statements in accordance with applicable statutes.

The city also follows best practices set by the Government Finance Officers Association (GFOA). The GFOA recommends that local governments rotate audit firms every 5-10 years. The rotation of audit firms is beneficial to allow a fresh perspective on the city's financials and internal control procedures.

The city's contract with Aldrich CPAs + Advisors LLP was originally scheduled to be in effect through the audit of fiscal year 2026; however, the city terminated the contract early due to lack of the firm's communication with Council and the city manager. Additionally, Aldrich requested to renegotiate the contract terms every year despite having a signed contract in effect, causing delays in beginning the audit process. Staff decided to end this relationship and seek audit services from a new firm.

In accordance with the city's Public Contracting Rules (PCRs), staff issued a formal competitive solicitation for audit services and received two responsive proposals – one each from Moss Adams LLP and SingerLewak Accountants & Consultants.

The proposal evaluation and interview process were conducted by both finance staff and two members of the Audit Committee. It was determined that Moss Adams LLP was most qualified to perform the services, pending a formal recommendation from the Audit Committee.

On May 13, staff attended an Audit Committee meeting to discuss the proposals. Following that conversation, the committee voted to recommend that Council award the audit services contract to Moss Adams.

The proposed initial term of the contract with Moss Adams will be through February 28, 2028, with the city reserving the right to extend the contract up to two additional one-year periods and fiscal year (FY) 2024 being the first reporting period to be audited.

BUDGET IMPACT

Over the initial five-year term, the contract with Moss Adams will cost \$441,475. The first two years of service are budgeted in the proposed biennial budget for 2025-2026. This cost includes audit expenses related to the audit of the Milwaukie Redevelopment Commission (MRC) and a single audit (i.e., federal awards expended over \$750,000 in a fiscal year).

CLIMATE IMPACT

None.

EQUITY IMPACT

None.

WORKLOAD IMPACT

Finance staff time will be impacted by increased workload for the first audit year as Moss Adams gains an understanding of city procedures and builds a client file.

COORDINATION, CONCURRENCE, OR DISSENT

The Audit Committee concurs with the recommendation of award to Moss Adams.

STAFF RECOMMENDATION

Staff recommends that Council adopt a resolution authorizing the acting city manager to execute a contract with Moss Adams for audit services.

ALTERNATIVES

Council could direct staff to reissue the solicitation with a revised scope of services allowing for additional staff time and disruption with the current audit schedule. A delay in the audit schedule would require staff to seek out a filing extension with both Secretary of State and GFOA for the third consecutive year.

ATTACHMENTS

1. Resolution

COUNCIL RESOLUTION No.

A RESOLUTION OF THE CITY COUNCIL OF THE CITY OF MILWAUKIE, OREGON, ACTING AS THE LOCAL CONTRACT REVIEW BOARD, AUTHORIZING A CONTRACT WITH MOSS ADAMS LLP FOR FINANCIAL AUDIT SERVICES.

WHEREAS the city is required to have an annual financial statement audit within six months of each fiscal year end; and

WHEREAS the city ended its relationship and contract early with Aldrich CPAs + Advisors LLP and decided to seek services elsewhere; and

WHEREAS a formal competitive solicitation for audit services was issued in compliance with the city's Public Contracting Rules (PCRs) and two responsive proposals were received; and

WHEREAS a selection panel consisting of city staff and members of the Audit Committee evaluated proposals and interviewed the two firms; and

WHEREAS the selection panel identified Moss Adams LLP as the most qualified and fully able to perform the services; and

WHEREAS the Audit Committee formally recommended Moss Adams LLP for award of contract.

Now, Therefore, be it Resolved by the City Council of the City of Milwaukie, Oregon, that the acting city manager or designee is authorized to execute a contract with Moss Adams LLP for financial audit services up to a seven-year period.

Introduced and adopted by the City Council on **June 4, 2024**.

This resolution is effective immediately.

Lisa M. Batey, Mayor

ATTEST:

APPROVED AS TO FORM:

Scott S. Stauffer, City Recorder

Justin D. Gericke, City Attorney

To: Mayor and City Council
Through: Emma Sagor, Acting City Manager
Reviewed: Scott Stauffer, City Recorder; and
Michael Osborne, Finance Director
From: Brandi Leos, Human Resources Director

Date: June 4, 2024

Subject: **Milwaukie Police Employee Association (MPEA) Three-Year Agreement**

ACTION REQUESTED

Council is asked to approve a three-year successor Collective Bargaining Agreement (CBA) with the Milwaukie Police Employees Association (MPEA) effective July 1, 2024, through June 30, 2027.

HISTORY OF PRIOR ACTIONS AND DISCUSSIONS

Council previously approved the current MPEA CBA which expires June 30, 2024.

MPEA has ratified the CBA.

ANALYSIS

The CBA includes a 6% cost of living adjustment (COLA) effective the first day of the pay period of July 1, 2024; 1% effective the first pay period of January 1, 2025; and Consumer Price Index (CPI) based COLAs in July 2025 (1-4% of CPI) and July 2026 (1-5% of CPI) in addition to 1% market adjustments in 2025 and 2026. The agreement also includes a 10% market adjustment for the property and evidence technician position effective with the first pay period of July 1, 2024. The CBA includes a new contribution to voluntary employee's beneficiary association (VEBA) accounts of \$35 per pay period effective the first pay period of January 1, 2025.

With the changes in the new CBA, MPEA staff salaries become approximately +/- 5% relative to the competitive market. The 2024-2027 CBA will keep the city competitive in terms of hiring new officers.

BUDGET IMPACTS

The changes in the CBA were included in the most recent budget presentation, planned to be adopted at the June 4, 2024, meeting.

CLIMATE, EQUITY, & WORKLOAD IMPACTS

None.

COORDINATION, CONCURRENCE, OR DISSENT

No dissent.

STAFF RECOMMENDATION

Staff recommends Council approve the three-year MPEA CBA as bargained between the city and MPEA, in consultation with Council.

ALTERNATIVES

Council could direct staff to return to the bargaining table to continue negotiations.

ATTACHMENTS

1. Resolution

COUNCIL RESOLUTION No.

A RESOLUTION OF THE CITY COUNCIL OF THE CITY OF MILWAUKIE, OREGON, AUTHORIZING A COLLECTIVE BARGAINING AGREEMENT WITH THE MILWAUKIE POLICE EMPLOYEES ASSOCIATION (MPEA).

WHEREAS the city is honorably served by the men and women represented by MPEA; and

WHEREAS the current contract between the city and MPEA expires on June 30, 2024; and

WHEREAS the city and representatives of MPEA, in consultation with the City Council, have negotiated a new three-year contract for the period of July 1, 2024, through June 30, 2027.

Now, Therefore, be it Resolved by the City Council of the City of Milwaukie, Oregon, that the city manager and human resources director are authorized to sign on behalf of the city an agreement with MPEA for a three-year collective bargaining agreement.

Introduced and adopted by the City Council on **June 4, 2024.**

This resolution is effective on **July 1, 2024.**

Lisa M. Batey, Mayor

ATTEST:

APPROVED AS TO FORM:

Scott S. Stauffer, City Recorder

Justin D. Gericke, City Attorney

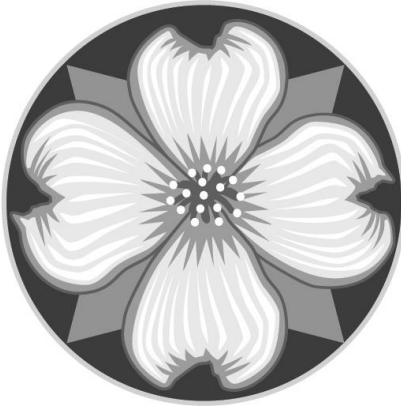

RS Agenda Item

8

Public Hearings

COUNCIL STAFF REPORT

To: Mayor and City Council
Emma Sagor, Acting City Manager

Date Written: May 28, 2024

Reviewed: Joesph Briglio, Community Development Director

From: Michael Osborne, Finance Director

Subject: **Fiscal Years 2025 and 2026 Consolidated Fee Schedule Update**

ACTION REQUESTED

Council is asked to adopt the proposed updated Consolidated Fee Schedule for fiscal years (FYs) 2025 and 2026

HISTORY OF PRIOR ACTIONS AND DISCUSSIONS

[April 2, 2024](#): Council reviewed the proposed FY 2025-2026 Consolidated Fee Schedule.

ANALYSIS

The city's fiscal policies state that the city will periodically and systematically review user fees and charges as adopted in an updated Consolidated Fee Schedule. Presented here is a two-year schedule that coincides with the biennium budget process.

The Consolidated Fee Schedule, if adopted, will go into effect on July 1, 2024, for FY 2025 and FY 2026. Each year departments review the fees and make changes as necessary. The suggested changes generally reflect either a new internal practice or a change in cost. The goal is to accurately recover costs incurred by the city, as stated below in the city's adopted fiscal policies:

The City will maximize the use of service and user charges in lieu of ad valorem taxes and subsidies from other city funds, for services that can be identified and where costs are directly related to the level of service provided. The Council may establish fees at less than "full cost recovery" when deemed in the public interest. The city will periodically and systematically review user fees and charges to take into account the effects of additional service costs and inflation.

The significant changes in the FY 2025 and FY 2026 update are as follows:

- The separate fee table for structural permits for single-family houses and new accessory dwelling units (ADUs) was eliminated. This discounted rate structure was intended to incentivize the development of additional detached housing structures on a lot. Recently adopted state and local policies prioritize the development of denser development to increase housing supply, including middle housing, and therefore this incentive structure is no longer needed.
- Erosion control fees have been updated for further clarification and to capture costs more accurately.

- Planning updates:
 - Staff recommend adding final plat (Type I) and lot consolidation (Type I) charges into the other land use applications table.
 - Staff recommend adding a new fee specifically for Type II property line adjustments that is already in the code. These adjustments are very rare and only done if someone needs to adjust a boundary in a way that impacts a plat restriction.
 - Staff recommend adding fines currently listed in Milwaukie Municipal Code (MMC) Titles 14, 17, and 19 into the fee schedule and removing them from code for ease of future updating.
 - Staff recommend increasing pre-application meeting fees for major applications, which have not been adjusted since 2013, and more clearly defining the difference between a minor and a major application.

- Water System Development Charges (SDCs) increased based on updated water SDC methodology. Wastewater, stormwater and transportation SDCs increased based on the Construction Cost Index (CCI) for Seattle, as called for in Resolution 40-2007, consistent with prior years. The five-year average for CCI is 5.64%.

- The administration percentage charge for Bancroft Financing for commercial SDCs increased from 2% to 5%.

- Utility rates will be adjusted in alignment with the recommendations endorsed by the Citizen Utility Advisory Board (CUAB). This includes an average monthly water service increase for residential customers will increase by 1.02% (or \$0.76), a revenue neutral adjustment to the fixed customer charge in the wastewater rate resulting in a 1.0% decrease (\$0.62) in the average residential service, no increase to the stormwater rates, and a monthly street maintenance fee increase of 5.6% (or \$0.68).

- Right-of-way (ROW) utility license fees on electric and natural gas providers increased from 5% to 8% of gross revenue.

- No changes to solid waste rates are proposed at this time. Council will discuss solid waste rate changes on June 18, 2024. If approved, these updated rates will be added to this fee schedule.

At the [April 2, 2024 work session discussion on the fee schedule](#), staff received the following questions from Council:

- **Why are business registration fees not increasing?** Based on community feedback from local businesses, they feel it is too high compared to other cities in the area. Some view it as a deterrent to business. Staff plan to review the Business Registration code in the future.

- **What is the justification for the increase in Bancroft financing administration rate from 2 to 5%?** The original rate did not adequately cover staff time and administrative costs incurred of managing these loans.

- **What costs will be covered by the ROW license fee increase?** The revenue collected from utility license fees pays for core services supported by the General Fund. This increase will specifically support rising costs for police, maintenance and operations of public facilities, and technological improvements, while also enabling existing General Fund programs that support Council goals of equity and climate to continue. Utility license fees [have](#) not increased since 2016, while General Fund revenues have stagnated in recent years and are not keeping up with rising costs. Generating additional revenue was not an action the city took lightly. In the 2025-2026 biennial budget, the city reduced or held expenses steady wherever possible-despite rising service demands. More information about the need for this increase can be found in the budget message provided during the [FY 2025-2026 Budget hearings](#).

The Consolidated Fee Schedule document is updated through the course of the year for changes or additions of fees approved by resolution or ordinance. Fees that are pass-through such as excise tax and others are also updated in the fee schedule once we are notified by the governing agency.

BUDGET IMPACTS

Overall, the fee schedule updates that are proposed reflect modest changes to improve clarity and more accurately cover costs for service. The proposed increases to the ROW utility licenses would have the most significant budget impact, helping to stabilize the city's financial forecast and avoid service cuts in this biennium.

WORKLOAD IMPACTS

Minimal impacts will occur city-wide to update the fees in the current systems used by staff. Several adjustments reflect the accurate cost of workload being performed by staff who provide fee-based services. The proposed ROW fee changes also reflect the need to increase revenues to cover the growing workload as demand for city services increase.

CLIMATE IMPACT

The fee schedule is designed to support the city's climate goals, including preserving tree canopy. Increasing the ROW license fees would allow the city to continue funding the climate coordinator position and climate work accomplished while this has been a Council goal.

EQUITY IMPACT

Wherever possible, fees were held level or reduced to minimize the impact on people living on low or fixed incomes. Several parts of the fee schedule also have low-income discounts, including planning fees and utility fees. Like the climate coordinator position and climate program, increasing the ROW license fees allows the city to continue funding the equity coordinator position and city's equity program.

COORDINATION, CONCURRENCE, OR DISSENT

Changes and updates were solicited from all department heads and staff.

STAFF RECOMMENDATION

Staff recommends that Council adopt a resolution to adopt the Consolidated Fee Schedule for FY's 2025 and 2026.

ALTERNATIVES

A delay in adopting the Consolidated Fee Schedule will leave current fees in place.

ATTACHMENTS

1. FY's 2025 and 2026 Consolidated Fee Schedule.
2. Proposed resolution adopting FY's 2025 and 2026 Consolidated Fee Schedule



CITY OF MILWAUKIE

CONSOLIDATED FEE SCHEDULE

Fiscal Years 2025 & 2026
Milwaukie, Oregon



City of Milwaukie, Oregon

The City of Milwaukie provides a full range of municipal services to the community, including police protection, traffic control and improvement, street maintenance and improvement, water, wastewater, and surface water management services, planning and zoning regulation, building inspection and regulation, and community library services. This Fee Schedule consolidates all City fees and charges adopted by City Council resolution for the various services that the city provides. Typically, it is updated annually and reflects all fee resolutions passed by Council during the year.

Fee Variance and Waiver Statement

Based upon an unusual circumstance or event, past practices, demonstrated hardship, or public benefit, the City Manager is authorized to waive or decrease a fee(s) or charge(s) in a matter or establish a fee not yet authorized in this schedule. When a new fee is established by the City Manager it shall be incorporated into this document, and it shall be included and specified during the next update to this document.

A waiver or reduction request must be in writing and communicated to Council to allow opportunity for comment. If the City Manager or their designee agrees to said waiver or reduction, he/she shall inform the City Council, in writing, of the request and his/her decision, except in minor matters (defined as waivers or reductions valued at \$1,000 or less).

Effective Dates and Resolutions

[Information to be added once fee schedule is adopted, and updated with any subsequent resolutions over the coming biennium.]

1. ADMINISTRATION.....1

2. BUILDING2

3. BUSINESS REGISTRATION.....11

4. DOWNTOWN PARKING12

5. ENGINEERING.....13

6. FEES IN LIEU OF CONSTRUCTION (FILOC) 15

7. LIBRARY16

8. MISCELLANEOUS.....17

9. MUNICIPAL COURT.....18

10. PLANNING20

11. TREES IN THE CITY25

12. POLICE.....30

13. SDC & CONSTRUCTION EXCISE TAX..... 31

14. UTILITIES36

15. RIGHT-OF-WAY UTILITY LICENSE 41

16. VIOLATIONS OF THE MUNICIPAL CODE 42

17. SOLID WASTE RATES.....46

1. ADMINISTRATION

a. Billable Hourly Rates

The City employee billable hourly rate shall be calculated as 2.5 times step 4 of the employee's job classification, to the nearest \$5 increment, unless otherwise specified. The classification schedule can be found on the City of Milwaukie website under Human Resources.

This calculation shall be used to recover costs for those services billed on an hourly basis, including, but not limited to professional services such as planning, engineering, public works, utility, financial, legal, and police services. The use of a multiplier of 2.5 is intended to recover all overhead, training, benefits, and other costs associated with a city employee's time. Any work performed during overtime hours shall be billed as the calculated hourly rate multiplied by 125 percent. The City Manager and/or department directors are authorized to adjust calculated billings to reflect the impact of unusual circumstances or situations.

2. BUILDING

Building fees include structural, mechanical, plumbing, and electrical charges. Fees are applicable to residential, commercial, and industrial properties unless otherwise specified.

a. Structural Permits¹

Valuation shall be calculated in accordance with OAR 918-050-0100.

Residential/Commercial/Industrial:

Permit Size	Fiscal Year 2025 Base Fee	Plus each additional \$1,000 over base fee	Fiscal Year 2026 Base Fee	Plus each additional \$1,000 over base fee
\$1 to \$5,000	\$150.75	\$0.00	\$150.75	\$0.00
\$5,001 to \$25,000	\$150.75	\$15.50	\$150.75	\$15.50
\$25,001 to \$50,000	\$460.75	\$11.50	\$460.75	\$11.50
\$50,000 to \$100,000	\$748.25	\$7.80	\$748.25	\$7.80
Over \$100,000	\$1,138.25	\$6.50	\$1,138.25	\$6.50
Minimum permit fee	\$150.75	\$0.00	\$150.75	\$0.00

¹ Permit fees are calculated based on the total valuation and square footage of the improvements.

Building Continued

Stand-alone Fire Suppression Systems (requires a backflow device when connected to potable water installed by licensed plumbing contractor or person exempt from licensing):

Permit Size	Fiscal Year 2025 Base Fee	Fiscal Year 2026 Base Fee
0 sq. ft. to 2,000 sq. ft.	\$157.80	\$157.80
2,001 sq. ft. to 3,600 sq. ft.	\$236.90	\$236.90
3,601 sq. ft. to 7,200 sq. ft.	\$296.15	\$296.15
7,201 sq. ft. and greater	\$551.45	\$551.45

Fire and Life Safety Plan Review Fee

Commercial properties only; 50% of the structural permit fee.

Essential Facilities Hazard Report Review

Commercial properties only; 1% of the structural and mechanical fees.

Initial Structural Plan Review Fees

75% of the permit fees.

Third Party Plan Review

For transfer of a plan review to a third party; 10% of the permit fee, \$65 minimum.

Building Continued:**b. Mechanical Permits****Residential:**

Fees per current Mechanical Permit Application:

Permit	Fiscal Year 2025 Base Fee	Fiscal Year 2026 Base Fee
Minimum permit fee	\$155.90	\$155.90
HVAC – for the installation of air handling unit including ducts		
Up to 10,000 cfm	\$27.40	\$27.40
Over 10,000 cfm	\$32.45	\$32.45
Air conditioning/heat pump (site plan required)	\$50.35	\$50.35
Alteration of existing HVAC system	\$23.40	\$23.40
Mini split system	\$23.40	\$23.40
Furnace install/relocate/replace including ductwork and vent		
Up to 100,000 BTU/h	\$23.40	\$23.40
Over 100,000 BTU/h	\$27.60	\$27.60
Vent for other than furnace	\$23.40	\$23.40
Hydronic Piping System	\$23.40	\$23.40
Install/relocate/replace heaters (room, suspended, wall/floor-mounted)	\$23.40	\$23.40
Environmental Exhaust and Ventilation – for the installation of		
Appliance vent	\$19.15	\$19.15
Dryer exhaust	\$15.50	\$15.50
Range hood/ other kitchen equipment	\$13.15	\$13.15
Each hood that is served by a mechanical exhaust or air conditioning	\$13.15	\$13.15
Exhaust system and single duct (bath fan) each	\$10.75	\$10.75
Exhaust system apart from heating or air conditioning	\$15.50	\$15.50
Fuel Piping and Distribution/LPG-NG-Oil fuel piping		
Up to four outlets (including gas tag)	\$27.60	\$27.60
Each additional outlet over four	\$2.95	\$2.95
Other Listed Applications		
Decorative fireplace or insert	\$44.40	\$44.40
Woodstove/pellet stove	\$58.75	\$58.75
Water heater/flue vent	\$23.40	\$23.40
Chimney-liner-flue -vent w/o appliance	\$23.40	\$23.40
Oil tanks/gas/diesel generators	\$23.40	\$23.40
Barbeque	\$23.40	\$23.40
Radon mitigation	\$23.40	\$23.40
Pool or spa heater/kiln	\$23.40	\$23.40

Building Continued

Mechanical Permits continued

Commercial/Industrial:

Valuation shall be calculated on the value of the equipment and installation costs. Use this section for commercial installation, replacement or relocation of non-portable mechanical equipment, or mechanical work not covered previously. Indicate the value of all mechanical labor, materials, and equipment.

Permit	FY 2025 Base Fee	Plus each additional over the base fee	FY 2026 Base Fee	Plus each additional over the base fee
Minimum permit fee	\$155.90	\$0.00	\$155.90	\$0.00
\$1 to \$5,000	\$155.90	\$0.00	\$155.90	\$0.00
\$5,001 to \$10,000*	\$155.90	\$2.50	\$155.90	\$2.50
\$10,001 to \$100,000**	\$280.90	\$19.15	\$280.90	\$19.15
Over \$100,000**	\$2,004.40	\$13.00	\$2,004.40	\$13.00
*Permit category stipulates additional over each \$100.				
**Permit category stipulates additional over each \$1,000.				

Initial Mechanical Plan Review Fees for Residential and Commercial/Industrial

50% of the permit fees.

Building Continued

c. Plumbing Permits

Permit	Fiscal Year 2025 Base Fee	Fiscal Year 2026 Base Fee
Minimum permit fee (Residential/Commercial/Industrial)	\$155.90	\$155.90
Utilities per 100 feet (Residential/Commercial/Industrial)	\$120.00	\$120.00
Catch basin	\$52.75	\$52.75
Drywells, each	\$118.45	\$118.45
Rain drain connector	\$52.75	\$52.75
Manholes, each	\$103.20	\$103.20
Addition, alterations, and repairs for Residential/Commercial/Industrial (per fixture)	\$33.60	\$33.60

Residential:

Fees per current Plumbing Permit Application:

Permit	Fiscal Year 2025 Base Fee	Fiscal Year 2026 Base Fee
Total bathrooms per dwelling		
1 bath dwelling (includes 1 kitchen)	\$654.90	\$654.90
2 bath dwelling (includes 1 kitchen)	\$723.65	\$723.65
3 bath dwelling (includes 1 kitchen)	\$860.00	\$860.00
Additional bathroom/kitchen	\$342.35	\$342.35
Manufactured home utilities	\$135.65	\$135.65
*Includes the first 100 ft. of water piping, wastewater and storm water lines, hose bibs, icemakers, under floor low point drains, and rain drain packages that include the piping, gutters, downspouts, and perimeter system.		
Interior Piping (water or sewer) (per floor)		
First floor	\$103.20	\$103.20
Each additional floor	\$35.90	\$35.90
Multipurpose or Continuous Loop Suppression Systems		
0 sq. ft. to 2,000 sq. ft.	\$165.75	\$165.75
2,001 sq. ft. to 3,600 sq. ft.	\$248.85	\$248.85
3,601 sq. ft. to 7,200 sq. ft.	\$311.15	\$311.15
7,201 sq. ft. and greater	\$579.25	\$579.25

Building Continued

Commercial/Industrial:

Valuation shall be calculated on the value of the equipment and installation costs. Fees per current Plumbing Permit Application:

Permit	Fiscal Year 2025 Base Fee	Plus each additional over the base fee	Fiscal Year 2026 Base Fee	Plus each additional over the base fee
Interior Piping (per fixture)	\$33.60	\$0.00	\$33.60	\$0.00
Initial plumbing plan review fees	30% of the plumbing permit fees			
Medical Gas permits				
\$1 to \$6,500	\$155.90	\$0.00	\$155.90	\$0.00
\$6,501 to \$10,000*	\$155.90	\$1.90	\$155.90	\$1.90
\$10,001 to \$100,000**	\$222.40	\$11.25	\$222.40	\$11.25
Over \$100,000**	\$1,234.90	\$7.80	\$1,234.90	\$7.80
Minimum permit fee	\$155.90	\$0.00	\$155.90	\$0.00
*Permit category stipulates additional over each \$100.				
**Permit category stipulates additional over each \$1,000.				

d. Electrical Permits

Residential/Commercial/Industrial

Fees per current Plumbing Permit Application:

Permit	Fiscal Year 2025 Base Fee	Fiscal Year 2026 Base Fee
Minimum permit fee	\$155.90	\$155.90
New Residential single or multifamily houses, includes attached garage:		
1,000 square feet or less	\$315.15	\$315.15
Each additional 500 square feet or portion	\$64.40	\$64.40
Limited energy - single family (per dwelling)	\$127.55	\$127.55
Limited energy - multi-family (per floor)	\$127.55	\$127.55
Protective Signaling-multi-family (per floor)	\$127.55	\$127.55

Building Continued

d. Electrical Permits

Residential/Commercial/Industrial

Permit	Fiscal Year 2025 Base Fee	Fiscal Year 2026 Base Fee
Services or feeders installation, alterations, and/or relocation		
200 amps or less	\$188.45	\$188.45
201 amps to 400 amps	\$249.40	\$249.40
401 amps to 600 amps	\$378.85	\$378.85
601 amps to 1,000 amps	\$564.40	\$564.40
Over 1,000 amps or volts	\$1,032.15	\$1,032.15
Temporary services or feeders installation, alteration, and/or relocation		
200 amps or less	\$110.00	\$110.00
201 amps to 400 amps	\$234.10	\$234.10
401 amps to 600 amps	\$315.15	\$315.15
601 amps to 1,000 amps	\$463.05	\$463.05
Over 1,000 amps or volts	\$877.25	\$877.25
Branch circuits		
Branch circuits without service or feeder, 1 st circuit	\$105.35	\$105.35
Branch circuits without service, each additional circuit	\$14.45	\$14.45
Branch circuits with service, each circuit	\$14.45	\$14.45
Miscellaneous (service or feeder not included)		
Each manufactured or modular dwelling, service, and/or feeder	\$127.60	\$127.60
Reconnect only	\$127.60	\$127.60
Pump or irrigation circle	\$127.60	\$127.60
Sign or outline lighting	\$127.60	\$127.60
Signal circuit(s) or limited energy panel, alteration or extension (commercial/industrial only)	\$127.60	\$127.60
Each additional inspection over the allowable	\$99.45	\$99.45
Renewable Electrical Energy		
5 kva or less (2)	\$162.70	\$162.70
5.01 kva to 15 kva (2)	\$194.25	\$194.25
15.01 kva to 25 kva (2)	\$316.45	\$316.45
Greater than 25 kva – 25 kva + each additional kva to 100 kva (max)	\$12.65	\$12.65
For Wind generation system		
25.01 kva to 50 kva (2)	\$632.95	\$632.95
50.01 kva to 100 kva	\$1,265.85	\$1,265.85
Master Electric Permit Application	\$100.00 one-time application fee	
Master Electric Permit Inspections	\$110.00 per hour	
Initial Electrical Plan Review Fees	25% of the electrical permit fee	
Third Party Plan Review	\$110.00	

Building Continued

e. Manufactured Homes

All jurisdictions in the Tri-County area shall charge a single fee for the installation and set-up of manufactured homes. This single fee shall include the concrete slab, runners, or foundations when they comply with the prescriptive requirements of the Oregon Manufactured Dwelling standard, electrical feeder and plumbing connections, and all cross-over connections.

Permit	Fiscal Year 2025 Base Fee	Fiscal Year 2026 Base Fee
Permit fee	\$445.00	\$445.00
Manufactured dwelling parks and mobile home parks fee ¹	Per current State Permit Fee	
Statewide Code Development, Training and Monitoring Fee	\$30.00	\$30.00

f. In-fill and Grading

Permit	Fiscal Year 2025 Base Fee	Fiscal Year 2026 Base Fee
In-fill and Grading Permit and Plan review fees for each		
1 to 50 cubic yards	\$100.00	\$100.00
51 to 100 cubic yards	\$150.00	\$150.00
101 to 1,000 cubic yards ⁵⁴	\$200.00	\$200.00
1,000 to 10,000 cubic yards	\$250.00	\$250.00
10,001 cubic yards or more	Total hourly cost ²	

¹ O.A.R. 918-600-0030.

² Costs to include supervision, overhead, hourly wages and benefits of employees involved.

Building Continued**g. Permit Related Fees**

Permit	Fiscal Year 2025 Base Fee	Fiscal Year 2026 Base Fee
State surcharge shall be collected in an amount as required by State law		
Building Moving/Demolition permits:		
2,000 square feet or less	\$110.00	\$110.00
Each additional 1,000 square feet or portion	\$40.00	\$40.00
Plan Review Fee	75% of the permit fee	75% of the permit fee
Prescriptive Solar PV Installation	\$100.00	\$100.00
Non-prescriptive Solar PV Installation per current structural fee by validation	See building valuation table	
Recreational Parks and Organizational Camps	Per current State Permit Fee	
Administrative fee for simple refunds	\$35.00	\$35.00
Administrative fee for simple refunds	\$250.00	\$250.00
Administrative fee for changing contracts simple	\$35.00	\$35.00
Administrative fee for changing contracts complex	\$250.00	\$250.00
Floating structure permit – follow the structural permit fee schedule		
Permit changes outside of normal scope	\$110.00 per hour	
Plan review fees required/requested changes, additions and revisions.	\$110.00 per hour	
Re-inspection fees	\$110.00	\$110.00
Replacement sheets (each)	\$23.00	\$23.00
Re-instatement fee	\$110.00	\$110.00
Investigation fee	\$110.00 per hour	
Inspections outside of normal business hours (min. 2 hours)	\$110.00 per hour	
Earthquake – restraint bracing	\$135.00	\$135.00
Plan reviews not designated elsewhere	30% of the permit fee	
Certificate of Occupancy	\$180.00	\$180.00
Temporary Certificate of Occupancy	\$180.00	\$180.00
Change of use/Occupancy	\$180.00	\$180.00
Technology fee – applies to all programs unless specified	5% of the permit fee	
Deferred Submittal fee (per Deferred Submittal)	70% of the permit fee calculated using the value of the deferred portion with a minimum of \$300.	
Phased permit fee (per phase)	\$300.00 + 10% of the total project permit fee (not to exceed \$1,500.00 per phase)	

3. BUSINESS REGISTRATION

Business Registration is required annually for all businesses doing business in the City.

Permit	Fiscal Year 2025 Fee	Fiscal Year 2026 Fee
Standard Base Fee	\$175.00	\$175.00
New Business Commencing between July 1 and December 31	\$88.00	\$88.00
Change in Business Ownership	\$15.00	\$15.00
Fee for each FTE	\$10.00	\$10.00
Temporary Business (2 weeks or less)	\$30.00	\$30.00
Delinquent Registration	10% of the original business tax plus interest at 9% per annum from the due date until full payment is received.	

Metro Business License versus City Business Registration or Both:

Instead of obtaining separate business licenses/registrations within each Portland-area city that you conduct business in, you can purchase a single license from Metro to construct, alter, and repair structures in 20 cities that have licensing/registration requirements in the metropolitan area, excluding Portland. The license covers all construction trades, both commercial and residential, as well as all landscape contractors. Exception: if your principal place of business is inside the City of Milwaukie, the business is required to apply for a City of Milwaukie Business Registration in addition to the Metro license.

For Metro applications, contact Metro at 503-797-1620 or visit their website at: <http://www.oregonmetro.gov/tools-working/regional-contractors-business-license>

4. DOWNTOWN PARKING

Downtown employees can purchase a permit for designated permit spaces. Customers and visitors of downtown Milwaukie can use the short-term parking spaces.

Parking Permit Fees ¹	Fiscal Year 2025 Fee	Fiscal Year 2026 Fee
Daily	\$7.00	\$7.00
Monthly	\$100.00	\$100.00
Quarterly	\$275.00	\$275.00
Discount for Bulk Pass Purchase (>10) ²	10%	10%
Replacement Pass (each)	\$7.00	\$7.00
Parking Variance Fee ³	\$40.00	\$40.00

Downtown Parklet Use Fees

Downtown parklets are reviewed through Engineering. Additionally, Parklets incur a use fee for the parking spaces which are due upon application approval.

Engineering Fees	Fiscal Year 2025 Fee	Fiscal Year 2026 Fee
New parklet application fee	\$150.00	\$150.00
New parklet right-of-way fee	\$150.00	\$150.00
Parklet renewal application fee	\$50.00	\$50.00
Parklet renewal right-of-way fee	\$95.00	\$95.00
Parklet plan review	\$150.00	\$150.00
Monthly Use Fee Per Parking Space		
Private seasonal platform	\$20.00	\$20.00
Hybrid parklet (25% discount from private)	\$15.00	\$15.00
Public parklet	No fee for parking space use	
Additional incurred costs (if applicable)	TBD based on location	
Signage for public and hybrid parklets	\$95.00	\$95.00

¹ For parking fines refer to section 9.

² Does not apply to daily permits.

³ Parking variance is subject to City approval for events and/or construction parking. Fee is charged per parking space and would be issued for no longer than a two-week period.

5. ENGINEERING

Engineering fees consist of plan review, inspections, permits, printed and electronic maps, and erosion control review.

Inspections and permits	Fiscal Year 2025 Fee	Fiscal Year 2026 Fee
Right-of-Way Permit Application¹		
Construction permit application	\$275.00	\$275.00
Sidewalk permit	\$55.00	\$55.00
Temporary street use	\$55.00	\$55.00
Use permit application	\$55.00	\$55.00
Parking closure downtown (per month, per space)	\$55.00	\$55.00
Lane closure (per week, per lane/block)	\$110.00	\$110.00
Road closure (per week, per block)	\$275.00	\$275.00
Major encroachment permit application	\$165.00	\$165.00
Minor encroachment permit application	\$55.00	\$55.00
Recording fee	\$113.00	\$113.00
Right-of-way re-inspection (beyond standard of 2)	\$105.00	\$105.00
Painted intersection permit	\$55.00	\$55.00
Subdivision construction inspection	5.5% of total construction cost (\$500 minimum)	
Public improvement construction inspection	5.5% of total construction cost (\$500 minimum)	
Street opening deposit	\$25.00 per sq. ft./\$1,500.00 minimum	
Street opening surcharge (under 5-year moratorium)	\$50.00 per sq. ft./\$3,000.00 minimum	
5-year moratorium surcharge		
1 st year of moratorium	\$250.00 per sq. ft.	\$250.00 per sq. ft.
2 nd year of moratorium	\$200.00 per sq. ft.	\$200.00 per sq. ft.
3 rd year of moratorium	\$150.00 per sq. ft.	\$150.00 per sq. ft.
4 th year of moratorium	\$100.00 per sq. ft.	\$100.00 per sq. ft.
5 th year of moratorium	\$50.00 per sq. ft.	\$50.00 per sq. ft.
Grading permit		
Minor (0 to 100 cy)	\$165.00	\$165.00
Major (100+ cy)	\$275.00	\$275.00
Flood plain review	Actual costs	
Flood plain inspection	Actual costs	
Building permit plan review – minor	\$85.00	\$85.00
Building permit plan review – major	\$165.00	\$165.00
Street vacation/rename request	\$2,750.00 deposit (actual cost billed per hourly rate)	
Request for stormwater rate reduction	\$75.00 deposit (actual cost billed per hourly rate)	
Franchise permit application	No charge	
Traffic control device request	No charge	
Engineering request	No charge	
ADA request for service	No charge	
Transportation fee review application	\$85.00 deposit (actual cost billed per hourly rate)	
Appeal to City council ²	\$330.00	\$330.00
Sewer dye test	\$110.00	\$110.00
Moving buildings ³	\$220.00 + \$85.00/hr. staff time + \$1,000.00 deposit	

¹ For right-of-way license fees related to utilities see section 14.

² Appeals only related to Engineering determination. See other relevant sections regarding appeals.

³ Performance bond amount at discretion of City Engineer.

Engineering Continued

Inspections and permits	Fiscal Year 2025 Fee	Fiscal Year 2026 Fee
Materials		
Public Works Standards	\$30.00	\$30.00
Sewer TV inspection tape	\$25.00	\$25.00
Electronic Drawing		
Paper – all sizes	\$6.00	\$6.00
Other format (plus \$45.00/hr. for additional work)	\$8.00	\$8.00
Reproduction charges (\$0.10 for additional pages)	\$1.00	\$1.00
Printed and electronic maps (GIS)		
Standard selection of GIS maps		
Full sheet (34" x 44")	\$50.00	\$50.00
½ sheet (22" x 34")	\$40.00	\$40.00
1/4 sheet (17" x 24")	\$30.00	\$30.00
1/8 sheet (11" x 17")	\$17.00	\$17.00
Electronic file (via electronic mail in PDF, JPG, GIF, or TIF formats)	\$17.00	\$17.00
Electronic file (for mailed media, which includes postage, handling, and media charges)	\$25.00	\$25.00
Aerial maps		
Full sheet (34" x 44")	\$55.00	\$55.00
½ sheet (22" x 34")	\$45.00	\$45.00
1/4 sheet (17" x 24")	\$35.00	\$35.00
1/8 sheet (11" x 17")	\$25.00	\$25.00
Electronic file (via electronic mail in PDF, JPG, GIF, or TIF formats)	\$17.00	\$17.00
Electronic file (for mailed media, which includes postage, handling, and media charges)	\$25.00	\$25.00
Custom maps		
Flat charge per hour plus cost of materials	\$60.00	\$60.00
Electronic file (for mailed media, which includes postage, handling, and media charges)	\$8.00	\$8.00
Erosion Control		
Erosion Control permit required when disturbing over 500 sq.ft. of soil or as determined by MMC 16.28. Permit fees include one (1) plan review, one (1) initial inspection fee, and one (1) final inspection fee. Development sites may require more than one permit depending on project size, staging and requested phasing of occupancy. An erosion control permit may include demolition, clearing, grading and/or construction phases of development.		
Permit Review Fees – includes one (1) plan review, one (1) initial inspection and one (1) final inspection.		
Erosion Control Permit Consultation Fee (up to 30 min consultation)	50.00	50.00
Discount for Certified Erosion and Sediment Control Lead (CESCL) assigned project staff	25% permit review fee reduction	25% permit review fee reduction
Discount for qualified affordable housing One or more units meeting MMC 3.60.050	25% permit review fee reduction	25% permit review fee reduction
Residential – Minor Site Disturbance: For small projects adding no additional building footprint. Must be less than 1000 sq. ft. total soil disturbance	100.00	100.00
Residential - Single Family Home For single detached units and/or detached additional dwelling units.	250.00	250.00
Residential – Duplex, Triplex, Quadplex	500.00	500.00
Residential - Townhouses Attached single units, one unit per taxlot	500.00	500.00

Residential - Cottage Cluster Three (3) to twelve (12) units per cluster, one cluster per permit	500.00	500.00
Residential – Multi-unit Housing Five (5) or more attached units in one building, fee applies per building	750.00	750.00
Residential – Multi-phase development Large site for phased development, including grading, subdivision, right-of-way improvements, and site utility work. Fee is in addition to phased individual site permits.	500.00	500.00
Residential 1200 CN plan review fee	50.00	50.00
Commercial/Industrial – Minor Site Disturbance For small projects adding no additional building footprint. Must be less than 1000 sq. ft. total soil disturbance	100.00	100.00
Commercial – Multiunit Housing Five (5) or more attached units in one building, fee applies per building	750.00	750.00
Commercial - < 30,000 sq. ft. disturbed	750.00	750.00
Commercial - ≥ 30,000 sq. ft. to < 1 acre	750.00	750.00
Commercial - ≥ 1 acre but < 5 acre	900.00	900.00
Commercial – > 5 acres	400.00	400.00
Industrial - < 30,000 sq. ft. disturbed	800.00	800.00
Industrial - ≥ 30,000 sq. ft. to < 1 acre	800.00	800.00
Industrial - ≥ 1 acre but < 5 acre	900.00	900.00
Industrial – > 5 acres	400.00	400.00
Permit reissuance fee (no significant site changes, no changes to submitted EC plan,)	50.00	50.00
Erosion Control Inspection Fees		
Residential Re-Inspection Fee (Initial, Final)	60.00	60.00
Residential Routine Inspection Fee	20.00	20.00
Commercial Re-Inspection Fee (Initial, Final)	80.00	80.00
Commercial Routine Inspection Fee	30.00	30.00
Industrial Re-Inspection Fee (Initial, Final)	80.00	80.00
Industrial Routine Inspection Fee	40.00	40.00
Non-compliance Inspection Fee	120.00	120.00
Erosion Control Violation Fees		
Erosion Control Violation (MMC 16.28)	\$300.00/day	\$300.00/day
Illicit Discharge Violation (MMC 13.14)	\$1,000.00/day	\$1,000.00/day

¹ Performance bond amount at discretion of City Engineer.

² Certification requires 4 hours of training in erosion control every two years.

6. FEES IN LIEU OF CONSTRUCTION (FILOC)

FILOC (Residential/Commercial/Industrial)	Fiscal Year 2025 Fee	Fiscal Year 2026 Fee
Transportation¹ , maximum per lineal foot of site frontage. Actual fee may be less depending on site conditions and actual improvements required.	\$340.00	\$340.00
Collectors, arterials, and public area requirements	Actual cost + 50%	
Water² – per lineal foot of site frontage	\$375.00	\$375.00
Stormwater³ – per lineal foot of site frontage	\$265.00	\$265.00
Wastewater⁴ – per lineal foot of site frontage	\$250.00	\$250.00
Stormwater Management⁵ – per square foot of new or changed	\$14.00	\$14.00

FILOC may be available as an alternative to construction of minimum required improvements in accordance with MMC 13.32. FILOC for Transportation, Water, Stormwater, Wastewater, and Stormwater Management Facilities are established by City Council based on impact of development on the infrastructure serving the proposed use. FILOC for Transportation, Water, Stormwater, and Wastewater are based on historical costs to construct the facility per lineal foot of frontage. FILOC for Stormwater Management Facilities is based on historical costs to construct a facility per square foot of added or changed impervious area draining to the public system. FILOC is indexed for inflation annually using the Engineering News-Record Construction Cost Index (CCI) for Seattle, WA (Resolution #79-2016), based on a 5-yr running average.

¹ Transportation FILOC is based on the historical cost to construct the minimum standard improvements for a local street.

² Water FILOC is based on the historical cost to construct the minimum standard water main.

³ Stormwater FILOC is based on the historical cost to construct the minimum standard storm main.

⁴ Wastewater FILOC is based on the historical cost to construct the minimum standard sanitary sewer main.

⁵ Storm Water Quality FILOC is based on the historical cost to construct the minimum required water quality facility for impervious surfaces created that drain to a public storm system without treatment.

7. LIBRARY

The Library collects fines for overdue books, lost or damaged items, and photocopying services.

Overdue Fines	Fiscal Year 2025 and 2026 Fee	Fiscal Year Maximum
Adult	\$0.10	\$1.00
Juvenile	\$0.10	\$1.00
Library of Things	\$1.00 per day	Replacement cost

Fees and Charges	Fiscal Year 2025 and 2026
Printing and Copies, per side	
Black and white	\$0.10
Color	\$0.50
Microfilm copies	
Lost or damaged items	Up to Replacement Cost
Non-district citizen library use (annual pass)	\$95.00

8. MISCELLANEOUS

Fees and Charges	Fiscal Year 2025	Fiscal Year 2026
Document printing and copying		
Black and white	\$0.10	\$0.10
Color	\$0.50	\$0.50
Lien docket searches	\$35.00	\$40.00
Filming permit – fee varies based upon production budget and time to review application. Fee may be waived under certain conditions.	\$2,400.00	\$2,400.00
South Downtown Plaza Reservations – Fee applies to full or partial closure of the South Downtown Plaza & festival street. Fee may vary based on size of event and staff involvement required. Fee may be waived at the discretion of the city manager or designee.	\$400.00	\$400.00
Temporary event permit – fee may be charged to cover costs incurred by the City for assisting with an event. Staff time will be based upon billable hourly rates.	No application fee	
Use of parking stall(s) in the right-of-way during a temporary event – City reserves the right to charge for required staff time if inspection is needed.	\$30.00	\$30.00
Maximum credit card transaction is \$10,000. All transactions greater than \$10,000 must be paid via cash, check, money order, or electronic funds transfer (EFT). This includes building permits, court fines, and other licensing or administrative services provided by the city.		

9. MUNICIPAL COURT

Milwaukie Municipal Court collects fines for traffic citations, parking violations, and miscellaneous programs approved by the Judge. Traffic fine amounts are set by State legislature based on the offense classification.

Fees and Charges	Fiscal Year 2025 Base Fee	Fiscal Year 2026 Base Fee
Payment plan installment fee	\$25.00	\$25.00
Failure to appear	\$40.00	\$40.00
Reinstatement fee	\$15.00	\$15.00
Suspension packet fee	\$15.00	\$15.00
Returned check fee	\$30.00	\$30.00
Boot release fee	\$50.00	\$50.00
Seat belt class fee	\$50.00	\$50.00
Collection processing fee	\$30.00	\$30.00
Audio CD – Court session	\$25.00	\$25.00
Trial cancellation fee	\$25.00	\$25.00
Young driver diversion fee		
Class B	\$200.00	\$200.00
Class C	\$100.00	\$100.00
Dismissal fee		
Class D	\$50.00	\$50.00
Deferred sentencing fee		
Class B	\$265.00	\$265.00
Class C	\$165.00	\$165.00
Class D	\$115.00	\$115.00

Traffic Fines				
Fiscal Year 2025 Fees				
Penalty	Presumptive Fine	Special Zone Fine¹	Minimum Fine	Maximum Fine
Class A	\$440.00	\$875.00	\$225.00	\$2,000.00
Class B	\$265.00	\$525.00	\$135.00	\$1,000.00
Class C	\$165.00	\$165.00	\$85.00	\$500.00
Class D	\$115.00	\$115.00	\$65.00	\$250.00
Fiscal Year 2026 Fees				
Class A	\$440.00	\$875.00	\$225.00	\$2,000.00
Class B	\$265.00	\$525.00	\$135.00	\$1,000.00
Class C	\$165.00	\$165.00	\$85.00	\$500.00
Class D	\$115.00	\$115.00	\$65.00	\$250.00

¹ Special zones include highway work zones, school zones, and safety corridors.

Municipal Court Continued

Parking Fines

Per Milwaukie Municipal Code §10.20.090E, parking fine amounts may increase by 50% when a registered vehicle owner has received four (4) or more previous citations for the same parking violation within a rolling 365-day timeframe. If bail is not posted by the court date, the fine will be doubled. (Ord. #2005, adopted 2009, Ord. #1997, adopted 2009, Ord. #1728, adopted 1993, and Ord. #1361, adopted 1977).

Parking Fines	Fiscal Year 2025 Fee	Fiscal Year 2026 Fee
Abandon vehicle	\$80.00	\$80.00
Angle parking	\$40.00	\$40.00
Bicycle lane	\$80.00	\$80.00
Blocking driveway	\$50.00	\$50.00
Block rule	\$40.00	\$40.00
Blocking disabled parking space	\$250.00	\$250.00
Bus zone/taxi zone	\$50.00	\$50.00
Double parking	\$50.00	\$50.00
During prohibited times	\$50.00	\$50.00
Emergency/safety zone	\$80.00	\$80.00
Fire hydrant	\$80.00	\$80.00
Five or more unpaid violations	\$60.00	\$60.00
Head-in only parking	\$50.00	\$50.00
Loading zone	\$50.00	\$50.00
No parking zone/tow away zone	\$80.00	\$80.00
On crosswalk/sidewalk	\$80.00	\$80.00
Over one foot from curb	\$60.00	\$60.00
Over space line	\$60.00	\$60.00
Overtime parking	\$60.00	\$60.00
Permit only parking ¹	\$60.00	\$60.00
Traffic hazard	\$80.00	\$80.00
Trucks – 2-hour limit	\$50.00	\$50.00
Disabled parking space	\$450.00	\$450.00
Wrong side of street	\$50.00	\$50.00
Where prohibited	\$80.00	\$80.00

¹ For parking permit fees see section 4.

10. PLANNING

The City Planning Department oversees land use applications, annexations, special requests, and procurement of City maps and master plans.

Standard Land Use Applications

The following standard fees apply to all land use applications¹ not listed below. Some applications may require additional fees as described below under Additional Application Fees on page 22.

Review type	Fiscal Year 2025 Fee	Fiscal Year 2026 Fee
Type I Administrative review	\$200.00	\$200.00
Type II Administrative review	\$1,000.00	\$1,000.00
Type III Quasi-judicial review	\$2,000.00	\$2,000.00
Type IV Quasi-judicial review	\$5,000.00	\$5,000.00
Type V Legislative review	\$5,000.00	\$5,000.00

Other Land Use Applications

Applications	Fiscal Year 2025 Fee	Fiscal Year 2026 Fee
Community service use – minor modification (Type I)	\$50.00	\$50.00
Final plat (Type I)	\$200.00	\$200.00
Historic resource designation (Type IV)	\$150.00	\$150.00
Lot consolidation (Type I)	\$200.00	\$200.00
Minor land partition, including Middle Housing or Expedited Land Division – preliminary plat review (Type II)	\$2,000.00	\$2,000.00
Natural Resource ²		
Boundary verification (Type I)	No charge	No charge
Construction management plan (Type I)	No charge	No charge
Natural resource management plan (Type I)	No charge	No charge
Tree removal request (Type I) ³	No charge	No charge
Tree removal request (Type III) ⁴	\$500.00	\$500.00
All other type I, II, or III Natural Resource applications ⁵	See fee for standard land use applications above	

¹ For a complete list of land use application types, see Milwaukie Municipal Code Table 19.901.

² Res. #77-2011, adopted 8/16/11.

³ See MMC 19.402.6.A for Type I tree removal. For tree removal in the right of way see section 5.

⁴ Required for any tree removal that is not Type I (MMC 19.402.8.A) or exempt (MMC 19.402.6.A). For tree removal in the right of way see section 5.

⁵ Fees waived for applications that meet all three of the following criteria: (1) the application involves only a habitat conservation area (HCA) and not a water quality resource (WQR), (2) the property is used for residential purposes, and (3) the current owner was the owner prior to September 15, 2011.

Planning Continued

Applications Continued	Fiscal Year 2025 Fee	Fiscal Year 2026 Fee
Planned development – preliminary plan review (Type III)	\$2,000.00	\$2,000.00
Planned development – final plan review (Type IV) ¹	\$5,000.00	\$5,000.00
Property line adjustment (Type I)	\$650.00	\$650.00
Property line adjustment (Type II)	\$1,000.00	\$1,000.00
Subdivision – preliminary plat review (Type III) ³	\$4,400.00 + \$100.00 per lot over 4 lots	
Subdivision for Middle Housing or Expedited Land Division (Type II)	\$2,000.00	\$2,000.00
Temporary structure (Type I)	\$50.00	\$50.00
Variance to fence height (Type II)	\$500.00	\$500.00
Annexations		
Annexation (expedited)	\$150.00	\$150.00
Annexation (Non-expedited: No zone change or comp plan amendment)	\$150.00	\$150.00
Annexation (Non-expedited: Zone change only)	\$500.00	\$500.00
Annexation (Non-expedited: Zone change and comp plan amendment)	\$3,500.00	\$3,500.00
Appeals		
Appeal to Planning Commission – per Oregon Statute (ORS 227.175 (10)(b)) ^{1,2}	\$250.00	\$250.00
Appeal to City Council ²	\$1,000.00	\$1,000.00

¹ The fee includes the zone change to apply the PD symbol to the zone map. Any change to the base zone requires an additional Type IV application and fee.

² A subdivision application fee is required for any subdivision that is being reviewed as part of a Planned Development.

Planning Continued

Additional Application Fees

Fee	Fiscal Year 2025 Fee	Fiscal Year 2026 Fee
Measure 56 Notice (for zoning map or text amendment)	Actual cost (\$1.00 per affected property, \$35.00 minimum)	
Reserve deposit	\$500.00	\$500.00
Technical report review ¹ Scope of work preparation Reserve deposit	Actual cost \$1,500.00	Actual cost \$1,500.00
Review of technical report (Res. #77-2011)	Actual cost	
Other reserve deposit Traffic Natural resources All other	\$2,500.00 \$3,000.00 \$1,000.00	\$2,500.00 \$3,000.00 \$1,000.00
Multifamily design review (Type I or II)	See fee for standard land use applications above.	
Downtown design review (type I, II, or III)	See fee for standard land use applications above.	
Discounts for Land Use Applications		
Two or More Applications (no discount for most expensive application). This discount applies to applications which relate to the same unit of land and which will be reviewed and decided concurrently.	25%	25%
Seniors must be at least 65 years of age and must be the property owner. Applicant may only receive one discount; the senior discount or the low-income discount.	25%	25%
Low-Income Residents may qualify for reduced fees by filing the same application used to apply for reduced sewer and water rates.	25%	25%
NDA-Sponsored Land Use Applications Related to Parks	Fees waived	
Fines³		
Violation of any provision of Title 14 (Signs)	\$100.00	\$100.00
Violation of any provision of Title 17 (Land Division)	\$200.00	\$200.00
Violation of any provision of Title 19 (Zoning)	\$200.00	\$200.00

Planning Continued

Deposit Information

In some cases, reserve deposits are collected to ensure that the City's actual expenses are covered. Deposits will be refunded relative to actual costs, and additional money may be required if actual costs exceed the deposit amount. This applies only to reserve deposits—base fees are nonrefundable.

¹ Actual cost to be determined by Planning Manager or City Engineer by estimating the cost of City staff time and resources dedicated to the project. See more information under Deposit Information.

² Fees are waived for NDA-sponsored appeals, pursuant to Resolution #26-1999.

³ The cost of completing or correcting any improvements required by the title in question and incurred by the City may be assessed to persons as part of the civil infraction judgment. Each day a violation continues will be considered a separate violation.

Planning Continued

Early Assistance

	Fiscal Year 2025 Fee	Fiscal Year 2026 Fee
Pre-application assistance for minor applications		
Pre-application meetings ¹		
First meeting	No charge	No charge
Second meeting	\$50.00	\$50.00
Third and subsequent meetings (per meeting fee)	\$100.00	\$100.00
Pre-application conference ²	\$200.00	\$200.00
Pre-application assistance for major applications		
Pre-application meetings ¹		
First meeting	No charge	No charge
Second meeting	\$100.00	\$100.00
Third and subsequent meetings (per meeting fee)	\$200.00	\$200.00
Pre-application conference ²	\$400	\$400

Minor Applications typically include:

- Type I applications
- Type II applications for projects that would result in;
 - four or fewer residential units, or
 - construction with 10,000 sq. ft. or less of new or additional floor area.

Type III applications for variances on sites with four or fewer residential units. Major Applications typically include:

- Multiple applications packaged together.
- Type II applications that result in:
 - more than four residential units, or
 - construction with more than 10,000 sq. ft. of new or additional floor area.
- Type III applications, except for variances on sites with four or fewer residential units.
- Type IV or V applications

Notes: Staff will use the above lists as a general guide for distinguishing minor and major applications and reserve the right to make a final determination. The City Manager (or designee) may reduce the fee for Early Assistance for a major application where it can be demonstrated that the level of staff effort required will be similar to what would be required for a Minor Application.

¹ Applies to optional meetings attended by a maximum of two City staff. No written notes provided.

² Applies to required or optional meetings that require three or more City staff. Written summary notes provided two weeks after meeting.

Planning Continued

Special Requests	Fiscal Year 2025 Fee	Fiscal Year 2026 Fee
Claims (pertaining to Measures 37 or 49) ¹	\$1,515.00	\$1,515.00
Significant Modification of Complete Land Use Application	\$500.00	\$500.00
Reschedule of Public Hearing at Applicant's Request (when re-notification is required)	\$500.00	\$500.00
Temporary Occupancy Request	\$100.00	\$100.00
Time Extension of Previously Granted Land Use Approval (Title 17 only)	\$50.00	\$50.00
Zoning Confirmation (General)	\$50.00	\$50.00
Zoning Confirmation (DMV Permit, LUCS) ²	\$25.00	\$25.00

Permit Review and Inspections	Fiscal Year 2025 Fee	Fiscal Year 2026 Fee
Zoning Confirmation (DMV Permit, LUCS) ² Building Permit Review and Inspections (Minor; e.g., Demolition or Erosion Control)	\$25.00	\$25.00
Building Permit Review and Inspections (Major)	\$200.00	\$200.00
Additional Planning Inspection Fee	\$50.00	\$50.00
Modifications to Building Permit during review ³	\$100.00	\$100.00
Original Art Mural	\$100.00	\$100.00
Sign Permit Review (per sign)	\$100.00	\$100.00
Sign Permit Review (daily display or "sandwich board" sign)	\$150.00	\$150.00

Materials

Most materials are available online for free or contact Planning for additional information:

<http://www.milwaukieoregon.gov/planning/planning-documents-ordinances-plans-and-guidelines>

The fee for a copy of any planning document (e.g. the comprehensive plan, the zoning ordinance, ancillary plans, etc.) shall be charged based on the number of copied pages. The standard City copy fee shall apply; refer to Section 8 of this document.

¹ Fee will be refunded if applicant prevails. If claim is denied, additional money may be required to cover contract-attorney or appraiser costs, as determined by City Manager.

² Waived for LUCS for emergency sewer connection.

³ Fee applies to site plan revisions generated by applicant, not those required by staff during review process.

11. TREES IN THE CITY

Trees are considered valuable urban infrastructure that should be nurtured and protected as a community asset. The Milwaukie Municipal Code Chapter 16.32 Tree Code, Council Ordinance 2197 is to establish, maintain, and increase the quantity and quality of tree cover on land owned or maintained by the City and within rights-of-way, and to ensure our urban forest is healthy, abundant, and climate resilient.

Per the City of Milwaukie Tree Code, a right-of-way (ROW) tree removal permit is required for all trees that are over 2" DBH (diameter at breast height) that are located in the ROW or on city property. A tree is in the ROW if any portion of its trunk falls in the ROW. A pruning permit is required if more than 20% of the tree's live crown is going to be removed or if roots within a radial distance of six times the tree's DBH will be impacted. To prune or remove a tree that is in the ROW, an ROW permit application must be submitted along with a \$50.00 application processing fee. A permit application is typically approved if the tree is invasive, dead/dying, diseased, has significant infrastructure impacts that cannot be reasonably mitigated, or poses an unreasonable risk to public safety. Replanting a street tree from Milwaukie's approved Street Tree List is a condition of permit approval.

Public Trees	Fiscal Year 2025 Fee	Fiscal Year 2026 Fee
Public Tree Removal or Major Pruning Application Fee	\$50.00	\$50.00
Public Tree Planting Permit	No charge	No charge
Healthy Public Tree Removal Fee		
Less than 2" DBH	\$40.00	\$40.00
2" to less than 4" DBH	\$60.00 per inch DBH	\$60.00 per inch DBH
4" to less than 8" DBH	\$80.00 per inch DBH	\$80.00 per inch DBH
8" to less than 14" DBH	\$100.00 per inch DBH	\$100.00 per inch DBH
14" to less than 20" DBH	\$150.00 per inch DBH	\$150.00 per inch DBH
20" or greater DBH	\$200.00 per inch DBH	\$200.00 per inch DBH
Public Tree Planting and Establishment Fee (in lieu of planting)	\$675.00 per tree	\$675.00 per tree
Public Tree Enforcement/Restoration Fee	2X Planting and Establishment Fee	2X Planting and Establishment Fee
Failure to Replant		
Damaged Tree	\$225.00 per inch DBH	\$225.00 per inch DBH
Removed Tree or Tree Topping	\$450.00 per inch DBH	\$450.00 per inch DBH

Trees in the City Continued

On April 19th, 2022, residential tree code (Ord. 2216) was adopted unanimously by city council as a way to complement the comprehensive plan housing and parking code updates while preserving and enhancing tree canopy in Milwaukie. Being a primarily residentially zoned community, the majority of Milwaukie's tree canopy is located on private property. To meet the established canopy goals of 40% canopy cover by 2040, Milwaukie adopted residential tree protections as a way to preserve existing trees and require the replanting of trees if another is removed. Development sites must also meet robust tree standards to ensure that new housing units are constructed with the community's canopy goals in mind.

Effective May 19th, 2022, trees that are greater than 6" DBH on residentially zoned private properties are regulated by the Milwaukie Tree Code (MMC 16.32.042). Property owners looking to remove a tree in a non-development situation must apply for a Type 1 or Type 2 tree permit before removal. Type 1 tree permits are for removal circumstances where the tree is dead, dying, hazardous, or impacting infrastructure or public safety in ways that cannot be mitigated. Type 1 tree permit applications are available at no cost to the applicant, and no removal fees are required. Type 2 tree permits are for the elective removal of healthy trees. Type 2 tree permits incur a \$50.00 application fee and if approved, applicants must pay healthy tree removal fees. Replanting is a condition of approval for most permitted tree removals.

The development tree code applies when new or additional housing units are constructed on residentially zoned properties, or when a property is being subdivided with the intention of constructing new housing units. The development tree code includes standards for tree preservation, tree planting, tree protection and soil volume requirements which must be met or mitigated for. Milwaukie's urban forest staff work with the city's community development department and engineering department, as well as the developers themselves, to meet the standards of the new tree code and integrate the requirements with the existing land use code and Public Works standards to create development sites that achieve the city's housing, parking and canopy goals.

Trees in the City Continued

Private Non-Development Tree Fees	Fiscal Year 2025 Fee	Fiscal Year 2026 Fee
Residential Tree Permit Application Fee (Type 1)	\$0.00	\$0.00
Residential Tree Permit Application Fee (Type 2)	\$50.00	\$50.00
Healthy private tree removal fee beyond one tree per 12-month period ¹ Measurements are in diameter at breast height (DBH). 6 to <12" DBH (approx.. 19" – 38" circumference) 12 to <18" DBH (approx.. 38" -57" circumference) 18" to <24" DBH (approx.. 57" -75" circumference) 24" to <30" DBH (approx.. 75" -94" circumference) 30" to <36" DBH (approx.. 94" -113" circumference) 36" or greater (greater than 113" circumference) Rare or Threatened Tree Removal	\$60.00 per inch DBH \$60.00 per inch DBH \$60.00 per inch DBH \$60.00 per inch DBH \$150.00 per inch DBH \$200.00 per inch DBH \$250.00 per inch DBH	\$60.00 per inch DBH \$60.00 per inch DBH \$60.00 per inch DBH \$60.00 per inch DBH \$150.00 per inch DBH \$200.00 per inch DBH \$250.00 per inch DBH
Planting and Establishment Fee in lieu of Replanting for Non-Development Private Residential Trees	\$675.00 per tree	\$675.00 per tree

Private Enforcement and Restoration Fees	Fiscal Year 2025 Fee	Fiscal Year 2026 Fee
Violation Review Fee (Development)	\$200.00	\$200.00
Damaged Private Tree	\$225.00 per inch DBH	\$225.00 per inch DBH
Tree Protection Violation Zone Fee	\$225.00 per inch DBH	\$225.00 per inch DBH
Unpermitted Private Tree Removal Fee (Development)		
6" to <12" DBH	\$2,000.00 per tree	\$2,000.00 per tree
12" to <18" DBH	\$167.00 per inch DBH	\$167.00 per inch DBH
18" to <24" DBH	\$200.00 per inch DBH	\$200.00 per inch DBH
24" to <36" DBH	\$250.00 per inch DBH	\$250.00 per inch DBH
36" or greater DBH	\$300.00 per inch DBH	\$300.00 per inch DBH
Unpermitted Private Tree Removal or Tree Topping (Non-Development)	2 x healthy private tree removal fee + \$250.00	2 x healthy private tree removal fee + \$250.00
Failure to Replant a Tree (Non-Development)	2 x Fee in Lieu	2 x Fee in Lieu

¹ No removal fee for 1st tree less than 12" DBH removed under type 1 permit.

Trees in the City Continued

Private Development Tree Fees	Fiscal Year 2025 Fee	Fiscal Year 2026 Fee
Residential Construction Tree Plan Review Fee	\$300.00	\$300.00
Site Inspection Fee	\$50.00	\$50.00
Site Re-inspection Fee	\$175.00	\$175.00
<p>Fee in lieu of preservation standard in residential development <i>Canopy percentage measurements are in sq ft canopy / total site sq ft</i></p>	<p>\$4,000.00 for each reduction of 7.5% site canopy coverage below 30% total site canopy. Fees are cumulative based on total canopy reduction.</p> <p>Remaining site canopy <30%-22.5%: \$4,000.00 <22.5%-15%: \$4,000.00 <15%-7.5%: \$4,000.00 <7.5%-0%: \$4,000.00</p>	<p>\$4,000.00 for each reduction of 7.5% site canopy coverage below 30% total site canopy. Fees are cumulative based on total canopy reduction.</p> <p>Remaining site canopy <30%-22.5%: \$4,000.00 <22.5%-15%: \$4,000.00 <15%-7.5%: \$4,000.00 <7.5%-0%: \$4,000.00</p>
<p>Fee in lieu of preservation standard for eligible residential affordable housing <i>Canopy percentage measurements are in sq ft canopy / total site sq ft</i></p>	<p>\$2,000.00 for each reduction of 7.5% site canopy coverage below 30% total site canopy. Fees are cumulative based on total canopy reduction.</p> <p>Remaining site canopy <30%-22.5%: \$2,000.00 <22.5%-15%: \$2,000.00 <15%-7.5%: \$2,000.00 <7.5%-0%: \$2,000.00</p>	<p>\$2,000.00 for each reduction of 7.5% site canopy coverage below 30% total site canopy. Fees are cumulative based on total canopy reduction.</p> <p>Remaining site canopy <30%-22.5%: \$2,000.00 <22.5%-15%: \$2,000.00 <15%-7.5%: \$2,000.00 <7.5%-0%: \$2,000.00</p>

Trees in the City Continued

Significant Tree Credits		
<i>Retained significant trees in diameter at breast height (DBH)</i>		
Retained significant tree 12" to <20" DBH	125% existing or future canopy multiplier	125% existing or future canopy multiplier
Retained significant tree >20" DBH	150% existing or future canopy multiplier	150% existing or future canopy multiplier
Retained significant tree >36" DBH	175% existing or future canopy multiplier	175% existing or future canopy multiplier
Rare or Threatened Tree Removal Fee	\$250.00 per inch DBH	\$250.00 per inch DBH
Fees in Lieu of Planting Standard	\$5.00 per square foot of canopy necessary to meet 40% site coverage	\$5.00 per square foot of canopy necessary to meet 40% site coverage
Bonding Requirements		
Tree Protection	\$3,500 per protected tree held for 3 years	\$3,500 per protected tree held for 3 years
Post Development	\$3,500.00 per newly planted tree held for 5 years	\$3,500.00 per newly planted tree held for 5 years

12. POLICE

The City's Police Department collects fees for permits, licenses, and other miscellaneous services listed below:

Fees and Charges	Fiscal Year 2025 Fee	Fiscal Year 2026 Fee
Permits/Licenses		
Adult business	\$372.00	\$372.00
Alarm permit – residential	\$25.00	\$25.00
Alarm permit – (65+)	\$10.00	\$10.00
Alarm permit – business	\$50.00	\$50.00
Gun background check	\$100.00	\$100.00
Liquor license (Original application)	\$100.00	\$100.00
Liquor license (Name or other change)	\$100.00	\$100.00
Liquor license (Renewal application)	\$150.00	\$150.00
Liquor license (Temporary license)	\$35.00	\$35.00
Police Reports		
Body worn camera footage	\$50.00 for 1 st 15 minutes to pull footage, \$50.00 for each addt'l hour to complete request	
Video copy	\$35.00	\$35.00
Police report	\$15.00	\$15.00
Photo CD	\$15.00	\$15.00
Traffic citation discovery	\$10.00	\$10.00
(additional research charges may apply for unusual/complex requests)		

Police Services	Fiscal Year 2025 Fee	Fiscal Year 2026 Fee
First false alarm response	No charge	
Second false alarm response		
Residential	\$25.00	\$25.00
Commercial	\$50.00	\$50.00
Third false alarm response		
Residential	\$50.00	\$50.00
Commercial	\$150.00	\$150.00
Fourth false alarm response		
Residential	\$150.00	\$150.00
Commercial	\$250.00	\$250.00
Fifth false alarm response		
Residential	\$250.00	\$250.00
Commercial	\$500.00	\$500.00
False alarm past fifth	No response	
Good conduct background letter	\$5.00	\$5.00
Vehicle impound	\$160.00	\$160.00
Loud party response – first response	Warning	
Loud party response – second response and/or each subsequent response in a 24 hr. period	\$50.00	\$50.00
Fire and emergency services fee (Ord. #1764, adopted 1994)	Actual cost	

13. SDC & Construction Excise Tax

SDC fees for Water, Stormwater, and Transportation shall be indexed for inflation annually using the Engineering-News Record Construction Cost Index (CCI) for Seattle (Resolution 40-2007). The CCI increase is 5.64%. Based on Oregon State Statute (ORS 223.304), the charges are broken down into three components; (1) reimbursement (to recover existing facility capacity available for growth), (2) improvement (to recover planned capacity improvements for growth), and (3) administration (to recover direct costs).

Water System Development Charge

Fiscal Year 2025 Fee				
<u>Meter</u>	<u>Reimbursement</u>	<u>Improvement</u>	<u>Compliance</u>	<u>Total</u>
3/4"x3/4"	\$525.00	\$4,682.00	\$396.00	\$5,603.00
1"	\$874.00	\$7,804.00	\$661.00	\$9,339.00
1.5"	\$1,749.00	\$15,608.00	\$1,321.00	\$18,678.00
2"	\$2,798.00	\$24,972.00	\$2,114.00	\$29,885.00
3"	\$5,596.00	\$49,944.00	\$4,229.00	\$59,769.00
4"	\$8,744.00	\$78,038.00	\$6,607.00	\$93,389.00
6"	\$17,489.00	\$156,075.00	\$13,214.00	\$186,779.00
8"	\$27,982.00	\$249,721.00	\$21,143.00	\$298,846.00
10"	\$40,225.00	\$358,973.00	\$30,393.00	\$429,591.00
12"	\$88,538.00	\$790,132.00	\$66,898.00	\$945,567.00

Fiscal Year 2026 Fee				
<u>Meter</u>	<u>Reimbursement</u>	<u>Improvement</u>	<u>Compliance</u>	<u>Total</u>
3/4"x3/4"	\$525.00	\$4,682.00	\$396.00	\$5,603.00
1"	\$874.00	\$7,804.00	\$661.00	\$9,339.00
1.5"	\$1,749.00	\$15,608.00	\$1,321.00	\$18,678.00
2"	\$2,798.00	\$24,972.00	\$2,114.00	\$29,885.00
3"	\$5,596.00	\$49,944.00	\$4,229.00	\$59,769.00
4"	\$8,744.00	\$78,038.00	\$6,607.00	\$93,389.00
6"	\$17,489.00	\$156,075.00	\$13,214.00	\$186,779.00
8"	\$27,982.00	\$249,721.00	\$21,143.00	\$298,846.00
10"	\$40,225.00	\$358,973.00	\$30,393.00	\$429,591.00
12"	\$88,538.00	\$790,132.00	\$66,898.00	\$945,567.00

SDC & Construction Excise Tax Continued

Scalable SDC by House Size

	EDU's	Max. Water SDC
Single-Family Residential		
<500 sqft (use ADU rate)	.60	\$3,362.00
500-800 sqft	.70	\$3,922.00
800-1,799 sqft	.90	\$5,043.00
1,800-2,999 sqft	1.00	\$5,603.00
3,000- 3,799 sqft	1.10	\$6,164.00
≥3,800 sqft	1.20	\$6,724.00
Accessory dwelling unit (ADU)	.60	\$3,362.00

SDC & Construction Excise Tax Continued

Wastewater System Development Charge

A wastewater unit is equal to 16 fixture units derived from Table 7-3 of the Oregon Plumbing Specialty Code. Each residential dwelling unit is 1 wastewater unit. Accessory Dwelling Units (ADUs) and duplex units are assumed to have a lesser impact and will be charged at 65% of the EDU rate. Multi-family over two units and all other development will be charged based on actual number of plumbing fixture units.

Fiscal Year 2025 Fee				
Wastewater SDC	Reimbursement	Improvement	Compliance	Total
Single-family dwelling	\$1,004.4 3	\$148.06	\$24.30	\$1,176.79
Duplex, ADU (per dwelling)	\$652.88	\$96.24	\$15.80	\$764.92
Other (per EDU)	\$1,004.4 3	\$148.06	\$24.30	\$1,176.79

Fiscal Year 2026 Fee				
Wastewater SDC	Reimbursement	Improvement	Compliance	Total
Single-family dwelling	\$1,061.0 7	\$156.41	\$25.67	\$1,243.15
Duplex, ADU (per dwelling)	\$689.70	\$101.66	\$16.69	\$808.05
Other (per EDU)	\$1,061.0 7	\$156.41	\$25.67	\$1,243.15

Stormwater System Development Charge

Stormwater unit is equal to 2,706 square feet of impervious surface on the property. Each single-family residential property is 1 Stormwater unit.

Fiscal Year 2025 Fee				
Stormwater SDC	Reimbursement	Improvement	Administration	Total
Single-family property (lot)	\$0.00	\$1,147.25	no charge	\$1,147.25
All other (per DRU)	\$0.00	\$1,147.25	no charge	\$1,147.25

Fiscal Year 2026 Fee				
Stormwater SDC	Reimbursement	Improvement	Administration	Total
Single-family property (lot)	\$0.00	\$1,211.95	no charge	\$1,211.95
All other (per DRU)	\$0.00	\$1,211.95	no charge	\$1,211.95

SDC & Construction Excise Tax Continued

Transportation System Development Charge

Trip generation rates for each land use type are derived from the Institute of Transportation (ITE) report Trip Generation (10th Edition, 2017). Trip rates are expressed as vehicle trips entering and leaving a property during the p.m. peak travel period.

Fiscal Year 2025 and 2026 Fee				
Transportation SDC	Reimbursement	Improvement	Administration	Total
Single-family dwelling (per unit)	<u>\$124.65</u>	<u>\$2,485.65</u>	no charge	<u>\$2,609.30</u>
Duplex, ADU (per unit)	<u>\$81.34</u>	<u>\$1616.29</u>	no charge	<u>\$1,697.63</u>
All other (per trip)	<u>\$124.65</u>	<u>\$2,485.65</u>	no charge	<u>\$2,609.30</u>

Parks and Recreation System Development Charge

This charge is set by the North Clackamas Parks and Recreation District. Rates herein are updated as changes are adopted by their governing board. Accessory Dwelling Units (ADUs) are charged half the rate of Single-Family. Visit www.ncprd.com/sdcs for information on Parks SDC's, including calculation of employees.

System Development Charge	Fiscal Year 2025 Fee	Fiscal Year 2026 Fee
Single-Family Residential (fee per dwelling unit)	\$3,985.00	\$3,985.00
Multifamily Residential (fee per dwelling unit)	\$3,608.00	\$3,608.00
Nonresidential (fee per employee)	\$60.00	\$60.00

School Construction Excise Tax

This charge is set by the North Clackamas School District. Rates herein are updated as changes are adopted by their governing board.

School Construction Excise Tax	Fiscal Year 2025 Fee ²	Fiscal Year 2026 Fee ³
Residential (fee per sq. ft.)	\$1.45	\$1.45
Commercial ¹ (fee per sq. ft.)	\$0.72	\$0.72

¹ Total commercial fee capped at \$36,100² per project. Private schools, public improvements, low-income (HUD) housing, hospitals, religious facilities, and agricultural buildings are exempt. Construction under 1,000 sq. ft. is exempt.

² Pending NCS D approval in June 2022. Subject to change

³ Rates to be determined in 2023. Subject to change.

SDC & Construction Excise Tax Continued

Metro Construction Excise Tax

This charge is set by Metro. Rates herein are updated as changes are approved by their governing board.

Permits for construction projects valued at \$100,000 or less will be exempted from this tax as well as permits for development of affordable housing units and permits issued to 501(c)(3) nonprofit organizations for other projects aimed at serving low-income populations. Permits for construction valued at more than \$10 million will be assessed a flat \$12,000 fee (0.12 percent of \$10 million).

Metro Construction Excise Tax	Fiscal Year 2025 Fee	Fiscal Year 2026 Fee
Metro Construction Excise Tax (fee per \$100.00 of permit value)	\$0.12	\$0.12

SDC & Construction Excise Tax Continued

Bancroft Financing for Commercial System Development Charges

Bancroft Financing provides the opportunity for property owners of single family, multi-family, not-for-profit, public organizations, and commercial properties, to finance system development charge(s) over a ten-year period, or less at the desire of the property owner, subject to the following interest rate (Ordinance 2108, adopted November 17, 2015):

Commercial System Development Charges	Fiscal Year 2025 Fee	Fiscal Year 2026 Fee
Bank Prime Rate	Subject to change as published by the Federal Reserve System ¹	Subject to change as published by the Federal Reserve System ¹
Administration	5.00%	5.00%
Total	Current prime rate plus administration	Current prime rate plus administration

Construction Excise Tax for Affordable Housing (CET-AH)

Construction Excise Tax for affordable housing will be assessed at 1 percent (1%) of permit value. Permits for construction projects valued at \$100,000 or less will be exempted from this tax as well as permits for development of affordable housing units at or below 80% Median Family Income (MFI), public Improvements under public contracting code, schools, hospitals, places of worship, agriculture, non-profit care, affordable for-sale single family housing—at or below 80 percent MFI, and Accessory Dwelling Units for 5 years from time of adoption. (Ordinance 2154, adopted November 21, 2017)

¹ The bank prime rate established by the Federal Reserve is updated periodically as determined by the Federal Reserve Board. The current bank prime rate can be found on the Federal Reserve website under “bank prime loan”.

14. UTILITIES

The City of Milwaukie provides water, wastewater, stormwater, and street maintenance service to residents. These services are billed monthly at the following rates¹:

Water	Fiscal Year 2025 Fee	Fiscal Year 2026 Fee
Water Volume Charge (per CCF of consumption)		
0-3 Units (residential only)	\$4.34	\$4.44
4 or more units (residential or all multi-family/commercial)	\$4.50	\$4.64
Low Use Discount		
Single Family Residential low use discount (3 or less CCF per month)	\$(5.00)	\$(5.00)

Residential & Commercial Meters – Fixed Charge²		
Meter Size	Fiscal Year 2025 Fee	Fiscal Year 2026 Fee
5/8" – 3/4"	\$9.35	\$9.53
1"	\$14.60	\$16.06
1 1/2"	\$24.07	\$27.08
2"	\$38.23	\$43.96
3"	\$94.25	\$108.38
4"	\$162.01	\$186.31
6"	\$239.01	\$274.86
Standby Service for fire Flow Purposes – Fixed Charge		
Meter Size	Fiscal Year 2025 Fee	Fiscal Year 2026 Fee
2"	\$15.23	\$15.74
4"	\$58.67	\$67.47
6"	\$92.85	\$116.06
8"	\$151.23	\$226.84
10"	\$191.07	\$286.60
12"	\$230.91	\$346.36

¹ The Citizens Utility Advisory Board reviews the existing rate structure and capital improvement plan to advise City Council on utility rates.

² Customers participating in the City’s Low-Income Utility Assistance program are exempt from the monthly fixed charge.

Utilities Continued

Wastewater

Account Type	Fiscal Year 2025 and 2026 Fees		
	Treatment (per EDU)	Billing and Administration (per account)	Volume ¹ (per CCF of water consumption)
Residential	\$34.36	\$4.35	\$3.99
Low Income	\$17.18	\$2.18	\$1.99
Multi-family/Commercial – 3/4” ²	\$34.36/\$74.68	\$10.23	\$3.99
Multi-family/Commercial – 1”	\$34.36/\$74.68	\$18.74	\$3.99
Multi-family/Commercial – 1 1/2”	\$34.36/\$74.68	\$25.64	\$3.99
Multi-family/Commercial – 2”	\$34.36/\$74.68	\$32.54	\$3.99
Multi-family/Commercial – 3”	\$34.36/\$74.68	\$46.34	\$3.99
Multi-family/Commercial – 4”	\$34.36/\$74.68	\$60.14	\$3.99
Multi-family/Commercial – 6”	\$34.36/\$74.68	\$87.75	\$3.99

Stormwater

Fiscal Year 2025 Fee			
Account Type	Single Family Residential	Low Income	Commercial (per 2,706 sq. ft. of impervious area)
Stormwater	\$29.47	\$14.73	\$29.47
Fiscal Year 2026 Fee			
Account Type	Single Family Residential ³	Low Income	Commercial (per 2,706 sq. ft. of impervious area)
Stormwater	\$29.47	\$14.73	\$29.47

¹ Residential wastewater volume charges are determined by the average monthly water usage from November to February (winter average). The winter average is adjusted annually on March 31st.

² Based upon water meter size. Multi-family EDU is billed per unit. A commercial EDU is equivalent to 10 CCF of usage.

³ Where an ADU is on the property, fee is only charged to the primary residence.

Utilities Continued

Transportation - Street Maintenance & SAFE Rates for All Categories

Account Type	Fiscal Year 2025 Fees SSMP	Fiscal Year 2026 Fees SSMP
Single Family Residential	\$6.06	\$6.40
Low Income	Exempt	
Commercial per daily trip generated ^{1,2}	\$0.62	\$0.66
Multi-Family Residential (per unit)	\$5.01	\$5.29
Elderly Housing/Mobile Homes (per unit)	\$2.49	\$2.63
Congregate Care (per unit)	\$1.25	\$1.32

Account Type	Fiscal Year 2025 Fees SAFE	Fiscal Year 2026 Fees SAFE
Single Family Residential	\$6.75	\$7.11
Low Income	Exempt	
Commercial per daily trip generated ^{1,2}	\$0.66	\$0.70
Multi-Family Residential (per unit)	\$5.41	\$5.71
Elderly Housing/Mobile Homes (per unit)	\$2.70	\$2.85
Congregate Care (per unit)	\$1.35	\$1.43

¹ Cost per commercial account are determined by type of use. Visit www.milwaukieoregon.gov/commercialfee for a detailed breakdown.

² Commercial daily trip generated is calculated based on type of use and building square feet. Some uses have monthly caps that are adjusted annually for CPI published by the Bureau of Labor Statistics. Current maximums are \$319.13 for the SSMP and \$419.42 for the SAFE programs as applicable. Visit www.milwaukieoregon.gov/commercialfee for more information.

Utilities Continued

Other Charges

Water	Fiscal Year 2025 Fee	Fiscal year 2026 Fee
Connect Service 5/8" or 3/4" Residential Service	\$1,030.00 shortside / \$1,120.00 long side	\$1,030.00 shortside / \$972.00 long side
Connect Service 1"	\$1,237.00 shortside / \$1,312.00 long side	\$1,237.00 shortside / \$1,312.00 long side
Connect Service 1 1/2"	\$2,400.00 shortside / \$2,530.00 long side	\$2,400.00 shortside / \$2,530.00 long side
Connect Service 2"	\$4,175.00 shortside / \$4,750.00 long side	\$4,175.00 shortside / \$4,750.00 long side
3/4" Meter Equipment	\$300.00	\$300.00
1" Meter Equipment	\$450.00	\$450.00
1 1/2" Meter Equipment	\$700.00	\$700.00
2" Meter Equipment	\$1,500.00	\$1,500.00
Hydrant Meter Deposit (refundable less water usage)	\$2,500.00	\$2,500.00
Hydrant Meter usage Fee per CFF	\$9.25	\$9.25
Sewer Connection	Fiscal Year 2025 Fee (per EDU) ³	Fiscal Year 2026 Fee (per EDU) ³
A fee charged to the City by Clackamas County and collected to recover invoiced costs for each new connection to the public sanitary sewer system.	\$8,860.00	\$8,860.00
A fee charged to the City by City of Portland and collected to recover invoiced costs for each new connection to the public sanitary sewer system.	\$8,913.00	\$8,913.00
A fee charged to the City by City of Portland and collected to recover invoiced costs for each new connection to the public sanitary sewer system for Middle Housing Development. Subject to change after the City of Portland updates the rates.	\$7,130.40	\$7,130.40

Miscellaneous	Fiscal Year 2025 Fee	Fiscal year 2026 Fee
Delinquent Account – Past Due Notice	\$8.00	\$8.00
Delinquent Account – Notice of Termination	\$15.00	\$15.00
Shut-off/Turn-on	\$35.00	\$35.00
Tamper Fee	n/a	\$150.00
After-hours Restoration of Service ²	\$110.00	\$110.00
Reimbursement District Fee	To be determined by the scope of project	

¹ An EDU or "equivalent dwelling unit" is a unit of measurement of sewer usage that is assumed to be equivalent to the usage of an average dwelling unit.

² After hours service is Monday-Friday 3:00-8:00 p.m.; Saturday and Sunday 8:00 a.m.-8:00 p.m.

Utilities Continued

Comparison Graph – Single Family Residential for FY 2025 and FY 2026

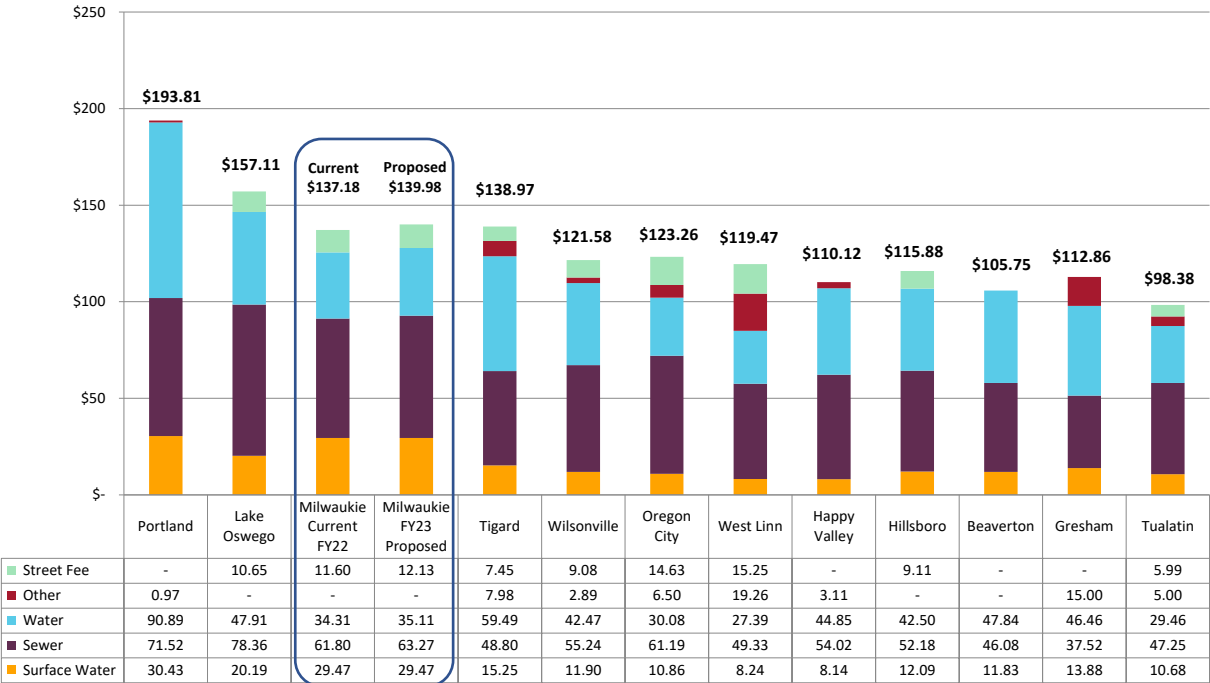

Comparison Graph of Average Utility Bills of Neighboring Cities (on a monthly basis)
Neighboring Cities proposed for July 1, 2024

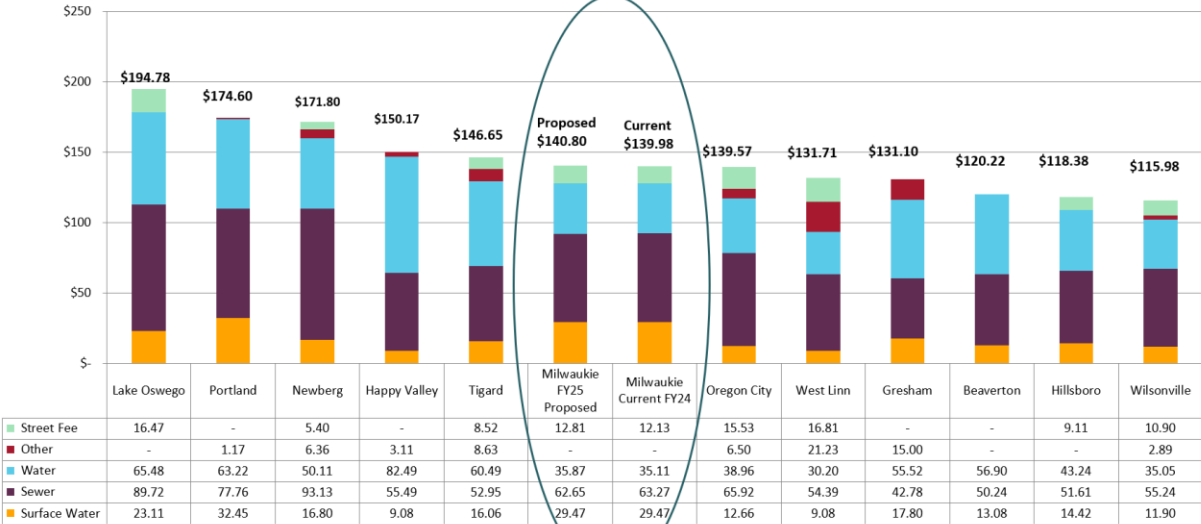

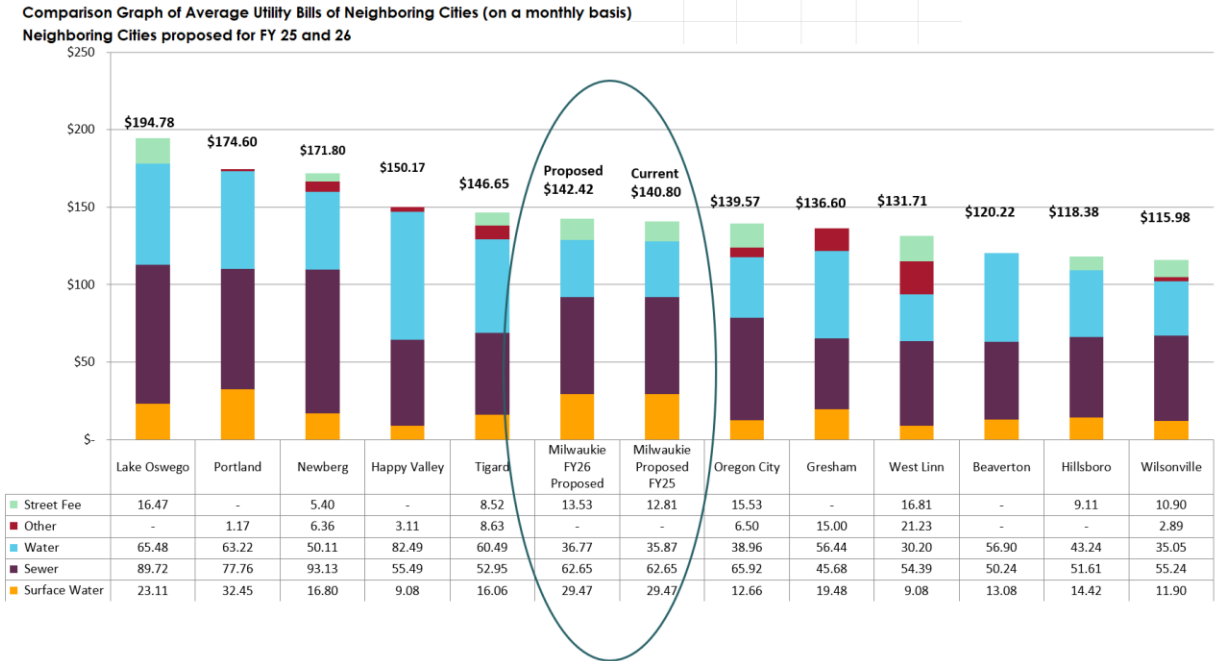

These graphs compare the average utility bills for the neighboring cities surrounding Milwaukie. As some cities bill monthly, some bill every two months, and some bill every three months, these amounts are converted to average monthly amounts, so they are comparable to Milwaukie. Also, cities increase different rates at different times during the year; therefore, this graph is simply a picture in time reflecting the rates at the time that the survey was conducted. And finally, cities have different average water consumption amounts per household; so for the sake of this comparison, these rates are computed using an average 6ccfs of water used per month to be comparable to Milwaukie's overall average. Below are Milwaukie's calculations:

SECTION 14: UTILITIES

	July 1 2023			July 1 2024			July 1 2025		
	Increased	avg. bill		Increased	avg. bill		Increased	avg. bill	
Water Service Fee									
Base	1.87%	0.17	\$ 9.25	1.08%	0.10	\$ 9.35	1.93%	0.18	\$ 9.53
Plus per 6ccf	2.50%	0.63	25.86	2.55%	0.66	26.52	2.71%	0.72	27.24
<i>Avg water per house (6ccfs)</i>			35.11			35.87			36.77
Sewer Service Fee									
Base fee	2.51%	0.84	34.36	0.00%	-	34.36	0.00%	-	34.36
Plus per 6ccf	2.23%	0.63	28.91	-2.14%	(0.62)	28.29	0.00%	-	28.29
<i>Avg sewer per house</i>			63.27			62.65			62.65
Storm Water Management Fee	0.00%	-	29.47	0.00%	-	29.47	0.00%	-	29.47
Street Maintenance Fee									
SSMP	4.55%	0.25	5.74	5.57%	0.32	6.06	5.61%	0.34	6.40
SAFE	4.58%	0.28	6.39	5.63%	0.36	6.75	5.63%	0.38	7.13
<i>Avg street per house</i>			12.13			12.81			13.53
<i>Average bill per residence</i>	2.04%	\$ 2.80	\$ 139.98	0.59%	\$ 0.82	\$ 140.80	1.15%	\$ 1.62	\$ 142.42
Maximum SSMP	0.046	16.48	374.68	0.0564	21.13	395.81	0.0564	22.32	418.14
Maximum SAFE	0.046	21.66	492.43	0.0564	27.77	520.21	0.0564	29.34	549.54

15. RIGHT-OF-WAY UTILITY LICENSE

The following fees apply to anyone using the City's Rights-of-way (ROW) in accordance with Resolution 3-2019.

Right-of-way licenses	Fiscal Year 2025 Fee	Fiscal year 2026 Fee
ROW application	\$50.00	\$50.00
ROW License (5 year)	\$250.00	\$250.00
Electric & Natural gas utility providers	8% of gross revenue	8% of gross revenue
Communications (other than Small Cell Wireless)	7% of gross revenue	7% of gross revenue
Cable Systems (franchise required)	5% of gross revenue	5% of gross revenue
Use of the City's ROW for any purpose other than generating revenue ¹	\$4.52 per linear foot or \$6,149.38 per year, whichever is greater	\$4.52 per linear foot or \$6,149.38per year, whichever is greater
Attachments to facilities within the City's ROW other than Small Cell Wireless ¹	\$6,149.38 per attachment	\$6,149.38per attachment
Small Cell Wireless Attachment	\$270.00 per attachment	\$270.00 per attachment
Small Cell Wireless ROW licensing and application fee	\$500+\$100 per site over 5 sites	\$500+\$100 per site over 5 sites

¹ This fee shall increase 3% annually on July 1 of each year beginning July 1, 2020.

16. VIOLATIONS OF THE MUNICIPAL CODE

Violation of the Milwaukie Municipal Code may result in the following fees or penalties. Each day that a violation exists is a separate offense.

General Code Violations		Fiscal Year 2025	Fiscal Year 2026
General penalty (applies to any Municipal Code violation where no other penalty is specified) ¹		\$150.00 - \$500.00	\$150.00 - \$500.00
Third or subsequent violation (applies to any Municipal Code violation) ¹	Maximum	\$1,000.00	\$1,000.00
Nuisance violation ²		\$500.00	\$500.00
Shopping cart retrieval programmatic violation ³		\$500.00	\$500.00
Noise control violation ⁴		\$500.00	\$500.00
Adult business code violation ⁵		\$500.00	\$500.00
Public urination or defecation ⁶	Up to	\$750.00	\$750.00
Curfew violation ⁷	Up to	\$300.00	\$300.00
Failure to retrieve shopping cart within 72 hours ⁸		\$50.00	\$50.00
Solid waste regulation/un-franchised violation ⁹	Up to	\$500.00	\$500.00
Abatement ¹⁰ (applies to any Municipal Code violation citation) ¹¹		\$50.00	\$50.00

Building Penalties		Fiscal Year 2025	Fiscal Year 2026
Violation of vacant building standards ¹²	Up to	\$300.00	\$500.00
Interference with fire control device ¹³	Up to	\$750.00	\$750.00
Swimming pool barrier violation ^{14,18}	Up to/per week	\$100.00	\$100.00
Building relocation violation ¹⁵	Not less than	\$1,000.00	\$1,000.00
Failure to comply with stop work order ¹⁶	Up to	\$1,000.00	\$1,000.00
Any violation of Title 15 for which a specific penalty has not been expressly provided ¹⁷	Up to	\$1,000.00	\$1,000.00

¹ Ord. #1935, adopted 2004, Ord. #1758, adopted 1994, and Ord. #1591, adopted 1986.

² Ord. #1503, adopted 1981, and Ord. #1028, adopted 1964.

³ Ord. #1980, adopted 2008.

⁴ Ord. #1528, adopted 1982.

⁵ Ord. #1533, adopted 1982.

⁶ Ord. #1953, adopted 2005.

⁷ Ord. #1503, adopted 1981, and Ord. #995, adopted 1963.

⁸ Ord. #1980, adopted 2008.

⁹ Ord. #1955, adopted 2005, Ord. #2092 adopted 2015.

¹⁰ All violations of the Municipal Code are additionally subject to the Code Enforcement abatement fee, additional state and county assessments and the general penalty for third or subsequent violations.

¹¹ Ord. #1998, adopted 2009, Ord. #1758, adopted 1994, and Ord. #1659, adopted 1989.

¹² Ord. #1464, adopted 1980.

¹³ Ord. #1515, adopted 1982.

¹⁴ Ord. #1430, adopted 1979.

¹⁵ Ord. #1952, adopted 2005.

¹⁶ Ord. #1881, adopted 2000.

¹⁷ Ord. #2011, adopted 2010.

¹⁸ Each week that this violation exists is a separate offense.

SECTION 16: VIOLATIONS OF THE MUNICIPAL CODE

Violations of the Municipal Code Continued

Motor Vehicle Fuel Tax Penalties¹	Fiscal Year 2025 Fee	Fiscal year 2026 Fee
Failure to secure motor vehicle fuel sales permit	200% penalty on tax owed + \$250.00	200% penalty on tax owed + \$250.00
Failure to file monthly motor vehicle fuel sales report	10% penalty on tax owed + \$50.00	10% penalty on tax owed + \$50.00
Late payment of motor vehicle fuel sales tax (depending upon length of delinquency)	1% or 10% of tax	5% of gross revenue

Specialty Code Penalties		Fiscal Year 2025	Fiscal Year 2026
Violation of various Specialty Codes: building, plumbing, mechanical and electrical ²	Up to/per week	\$1,000.00	\$1,000.00
	Maximum	\$5,000.00	\$5,000.00
Appeal of Specialty Code violation ³	Up to	\$200.00	\$200.00

¹ Ord. #1970, adopted 2007.

² Ord. #1814, adopted 1997, and Ord. #2011, adopted 2010.

³ Ord. #2011, adopted 2010.

Violations of the Municipal Code Continued

Engineering Penalties		Fiscal Year 2025	Fiscal Year 2026
Violation of capital improvement regulations ¹	Up to	\$500.00	\$500.00
Basketball hoop regulation violation ²	Up to	\$250.00	\$250.00
Vegetation too low in the right-of-way ³	Up to	\$100.00	\$100.00
Clear vision violation ⁴	Up to	\$250.00	\$250.00
Failure to repair sidewalk ⁵	Up to	\$250.00	\$250.00
Sidewalk bench violation ⁶	Up to	\$100.00	\$100.00
Failure to remove street bench after permit termination ⁷		\$25.00	\$25.00
Flood hazard violation ⁸	Up to	\$1,000.00	\$1,000.00
Access management violation ⁹	Up to	\$250.00	\$250.00
Right-of-way encroachment ¹⁰	Up to	\$250.00	\$250.00
Erosion control violation ¹¹	Up to	\$300.00	\$300.00
Unpermitted tree cutting in the public right-of-way ¹²		\$1,000.00	\$1,000.00

¹ Ord. #1707, adopted 1991.

² Ord. #1503, adopted 1981, and Ord. #1405, adopted 1978.

³ Ord. #1999, adopted 2009.

⁴ Ord. #1679, adopted 1990.

⁵ Ord. #1697, adopted 1991.

⁶ Ord. #1503, adopted 1981, and Ord. #1289, adopted 1974.

⁷ Ord. #1289, adopted 1974.

⁸ Ord. #1983, adopted 2008, and Ord. #1899, adopted 2002.

⁹ Ord. #2004 adopted 2009.

¹⁰ Ord. #2004 adopted 2009, and Ord. #1866 adopted 2000.

¹¹ Ord. #1899 adopted 2002.

¹² (Title 16) Ord. #1836, adopted 1998.

Violations of the Municipal Code Continued

Police Penalties		Fiscal Year 2025	Fiscal Year 2026
Weapon discharge violation ¹	Up to	\$750.00	\$750.00
Public consumption of alcohol ²	Up to	\$250.00	\$250.00
Failure to pay Fire and Emergency Services Fee ³	Up to	\$300.00	\$300.00
Security Alarm Violation ⁴	Maximum	\$500.00	\$500.00
Traffic violation penalty ⁵	At least 50% of maximum under Oregon Statute		

Planning Penalties		Fiscal Year 2023	Fiscal Year 2024
Violation of Sign Ordinance ⁶	Up to	\$100.00	\$100.00
Violation of land Division Ordinance ⁷		\$200.00	\$200.00
Violation of Zoning Ordinance ⁸	Up to	\$200.00	\$200.00

Utility Penalties		Fiscal Year 2025	Fiscal Year 2026
Low-income utility rate violation ⁹	Up to	\$200.00	\$200.00
Water, wastewater, or storm system regulation violation ¹⁰		\$25.00 - \$500.00	\$25.00 - \$500.00
Sewer violation ¹¹	Maximum	\$500.00	\$500.00
Fats, oils, and grease violation ¹²	Maximum	\$500.00	\$500.00

Business Registration Penalties		Fiscal Year 2025	Fiscal Year 2026
Violation of business registration requirements ¹³	Up to	\$200.00	\$200.00
Violation of "Milwaukie Junk Dealers, Secondhand Dealers, Pawnbrokers and Transient Merchants Ordinance" ¹⁴	Up to	\$300.00	\$300.00

¹ Ord. #1515, adopted 1982.

² Ord. #1746, adopted 1993.

³ Ord. #1767, adopted 1994, and Ord. #1764, adopted 1994.

⁴ Ord. #1568, adopted 1984.

⁵ Ord. #1922, adopted 2003.

⁶ Ord. #1965, adopted 2006, and Ord. #1733, adopted 1993.

⁷ Ord. #1907, adopted 2002.

⁸ Ord. #2025, adopted 2011.

⁹ Ord. #1424, adopted 1979.

¹⁰ Ord. #1418, adopted 1978, Ord. #1548, adopted 1986 and Ord. #1755, adopted 1994.

¹¹ Ord. #1548, adopted 1983.

¹² Ord. #1990, adopted 2008, Ord. #1985, adopted 2008, and Ord. #1972, adopted 2007.

¹³ Ord. #1863, adopted 1999, and Ord. #1349, adopted 1976.

¹⁴ Ord. #1552, adopted 1983.

17. SOLID WASTE RATES

Weekly collection includes recycling and yard debris service. Recycling carts and bins and yard debris carts must be placed at the curb.

Uniform Monthly Residential Rates:	Fiscal Year 2025 Fee	Fiscal Year 2026 Fee
20 gallon can (mini-can): 1 can/cart (1 time/week) <i>Weekly collection includes recycling and yard debris service</i>	\$32.95	\$32.95
32 gallon can/cart: 1 can/cart (1 time/week) 2 cans/cart (1 time/week) Each additional can/cart Extra can of garbage (occasional)* Extra can of yard debris (occasional) Court apartments – recycling only (1 time/week) <i>*This rate is for the first extra can collected, each additional at the stop is \$3.00. Maximum weight for a 20 or 32 gal. can/cart is 60lbs. Additional stops per week are charged at 100% of the first stop per week rate.</i>	\$38.20 \$76.40 \$38.20 \$6.90 \$4.65 \$31.50	\$38.20 \$76.40 \$38.20 \$6.90 \$4.65 \$31.50
Roller carts: 60 gallon cart (1 time/week) 90 gallon cart (1 time/week) Extra can of yard debris (occasional) Cart deposit (Refunds will be made after return of cart or after five years – whichever comes first.) Redelivery charge (redelivery within one year, regardless of reason) <i>Additional stops per week are charged at 125% of the first stop per week rate. Maximum weight for 60 gal. cart is 100lbs and for 90 gal. cart is 120lbs.</i>	\$49.80 \$59.00 \$4.65 \$31.20 \$10.00	\$49.80 \$59.00 \$4.65 \$31.20 \$10.00
Monthly and On Call service: Monthly On call <i>Monthly service includes recycling but not yard debris service. Monthly and on call customers must subscribe for one year in advance for yard debris service. On call customers must provide hauler with 24 hours' notice.</i>	\$19.00 \$19.80	\$19.00 \$19.80

Solid Waste Rates continued

Weekly collection includes recycling and yard debris service. Recycling carts and bins and yard debris carts must be placed at the curb.

Uniform Monthly Commercial Rates:	Fiscal Year 2025 Fee	Fiscal Year 2026 Fee
32 gallon can/cart: 1 can/cart (1 time/week) 2 cans/cart (1 time/week) Each additional can/cart Extra can of garbage (occasional)* <i>Additional stops per week are charged at 100% of the first stop per week rate.</i>	\$32.65 \$65.30 \$27.50 \$5.75	\$32.65 \$65.30 \$27.50 \$5.75
Roller carts: 60 gallon cart (1 time/week) 90 gallon cart (1 time/week) Cart deposit (Refunds will be made after return of cart or after five years – whichever comes first.) Redelivery charge (redelivery within one year, regardless of reason) <i>Additional stops per week are charged at 125% of the first stop per week rate.</i>	\$46.20 \$51.50 \$31.20 \$10.00	\$46.20 \$51.50 \$31.20 \$10.00
Compacted Containers: 2.2 times the loose container rate <i>Containers weighing in excess of 500 lbs per cubic yard will be charged this rate plus disposal for the excess weight.</i> <i>Compactors furnished by the customers shall be compatible with the equipment of the collector. If the collector agrees to furnish the compactor, the collector may charge a reasonable rental rate based on the value of the compactor and the cost of repair and maintenance.</i>		

Uniform Monthly Drop Box Rates:	Fiscal Year 2025 Fee	Fiscal Year 2026 Fee
Loose material: 10/20 yards 30 yards 40 yards	\$170.00 \$180.00 \$190.00	\$170.00 \$180.00 \$190.00
Lidded/Specialized box that cannot be exchanged: 10/20 yards <i>*Plus disposal costs</i> <i>An additional \$40.00 per drop box may be charged for one-stop service (plus disposal costs).</i> <i>Deposits of no more than \$500.00 may be charged for each drop box.</i>	\$170.00	\$170.00
Compacted material: Under 25 cubic yards 25-34 cubic yards 34+ cubic yards <i>*Plus disposal costs</i> <i>Rental rate for permanent boxes hauled at least weekly is \$50.00 per month. Rental rate for occasional boxes after 48 hours on location is \$6.30 per day or \$63.00 a month, whichever is less, if less than one load per week is hauled. Monthly Equipment Fee of \$20.00 for Lidded/Specialty Drop Boxes.</i> <i>Mileage charge of \$4.70 per mile (over 18 miles round-trip from shop or Metro South). Deadhead round trip for boxes that cannot be exchanged: \$25.00.</i>	\$170.00 \$209.00 \$238.00	\$170.00 \$209.00 \$238.00

Special Wastes delivered to an appropriately permitted landfill		
10/20 yards	\$181.00	\$181.00
30 yards	\$198.00	\$198.00
<i>*Plus disposal, monthly rental, mileage and monthly specialty drop box fees.</i>		

Solid Waste Rates continued

Uniform Rates for Misc. Services – Commercial and Residential:	Fiscal Year 2025 Fee	Fiscal Year 2026 Fee
Hourly fee:		
Truck + 1 person	\$90.00	\$90.00
Truck + 2 people	\$130.00	\$130.00
Other Miscellaneous:		
Furniture and recyclable appliance pick-up	\$5.70 to \$30.35	\$5.70 to \$30.35
Tire pick-up (off rim)	\$3.00**	\$3.00**
Tire pick-up (on rim)	\$6.00**	\$6.00**
Over 18 inches	Special handling rate	
<i>*Plus \$30.00 freon removal charge.</i>		
<i>**Plus disposal.</i>		
Clean-up Containers:		
1 st collection	33% of regular container rate + \$17.25 handling charge.	33% of Regular Container Rate +\$17.25 Handling Charge
Each additional collection	33% of regular container rate.	33% of Regular Container Rate
Rent of container after 5 working days (M-F) with no collection:		
1-2 yards	\$3.00/day	\$3.00/day
3 yards	\$4.00/day	\$4.00/day
4 yards	\$5.00/day	\$5.00/day
<i>Rent not to exceed \$20.00 per container in a 30-day period.</i>		

Non-Customer Services:	Fiscal Year 2025 Fee	Fiscal Year 2026 Fee
Recycling only:		
Weekly curbside collection of recyclables	\$7.70	\$7.70
Yard debris subscription service annual rate must be paid in full in advance of service		
60 gallon cart	\$6.50	\$6.50
Extra can of yard debris	\$4.90	\$4.90
	\$3.85	
<i>Monthly rates are for weekly service.</i>		
<i>This service is provided only within the Urban Growth Boundary.</i>		
<i>The subscriber is required to pay for one year of service in advance.</i>		

ANY OTHER TYPE OF SERVICE:

If due to changes in technology or needs of residents and business people of Milwaukie, additional or other types of services are needed, the charge for the service shall not be discriminatory, shall be reasonable by being commensurate with the fees above, and shall not exceed the fees most generally applicable in the Portland Metropolitan area.

Solid Waste Rates continued

Commercial container fees as of July 1, 2022, and effective through June 30, 2023. Fees include garbage and recycling services. Collector shall furnish the container. Overweight charge for containers over 300 lbs. per cubic yard determined through mutual agreement between hauler and customer. Container cleaning, if required more than twice in 12 months, will be charged the actual cost of cleaning.

Stops/ Week	Size in Cubic Yards					
	1	Add'l	1 1/3	Add'l	1.5	Add'l
1	\$112.28	\$97.84	\$140.31	\$122.15	\$150.43	\$132.28
2	\$216.80	\$189.57	\$272.91	\$239.18	\$293.11	\$257.12
3	\$321.34	\$279.88	\$405.48	\$355.19	\$435.81	\$382.50
4	\$425.86	\$373.05	\$538.07	\$471.82	\$578.46	\$507.08
5	\$530.41	\$463.36	\$670.65	\$587.83	\$721.15	\$635.32
6	\$634.93	\$555.71	\$803.24	\$703.16	\$863.82	\$759.31

Stops/ Week	Size in Cubic Yards					
	2	Add'l	3	Add'l	4	Add'l
1	\$191.92	\$168.82	\$264.87	\$233.93	\$339.97	\$302.43
2	\$376.09	\$331.82	\$517.28	\$457.95	\$667.53	\$593.75
3	\$560.28	\$494.03	\$769.70	\$682.61	\$995.07	\$884.21
4	\$744.47	\$653.90	\$1,022.13	\$909.34	\$1,322.61	\$1,172.07
5	\$928.66	\$821.14	\$1,274.57	\$1,132.42	\$1,650.14	\$1,466.49
6	\$1,112.84	\$981.58	\$1,526.97	\$1,352.19	\$1,977.70	\$1,757.24

Stops/ Week	Size in Cubic Yards					
	5	Add'l	6	Add'l	8	Add'l
1	\$412.76	\$388.01	\$478.46	\$449.99	\$598.12	\$565.11
2	\$811.89	\$763.10	\$943.31	\$888.50	\$1,182.61	\$1,117.26
3	\$1,211.04	\$1,136.05	\$1,408.14	\$1,320.71	\$1,767.11	\$1,669.63
4	\$1,610.14	\$1,510.65	\$1,872.99	\$1,759.45	\$2,351.60	\$2,219.99
5	\$2,009.31	\$1,888.24	\$2,337.84	\$2,197.80	\$2,936.11	\$2,763.39
6	\$2,408.43	\$2,268.38	\$2,802.69	\$2,629.97	\$3,520.60	\$3,319.72

Solid Waste Rates continued

Commercial container fees as of August 1, 2023, and effective through June 30, 2024. Fees include garbage and recycling services. Collector shall furnish the container. Overweight charge for containers over 300 lbs. per cubic yard determined through mutual agreement between hauler and customer. Container cleaning, if required more than twice in 12 months, will be charged the actual cost of cleaning.

Container Size	Stops per Week					
	1	2	3	4	5	6
1 yard	\$ 117.74	\$ 227.71	\$ 337.71	\$ 447.68	\$ 557.69	\$ 667.66
Add'l Cont.	103.30	200.48	296.25	394.87	490.64	588.44
1-1/3 yard	147.57	287.42	427.25	567.09	706.93	846.78
Add'l Cont.	129.41	253.69	376.96	500.84	624.11	746.70
1-1/2 yard	158.61	309.48	460.36	611.19	762.07	912.92
Add'l Cont.	140.46	273.49	407.05	539.81	676.24	808.41
2 yard	202.83	397.91	593.01	788.12	983.22	1,178.31
Add'l Cont.	179.73	353.64	526.76	697.55	875.70	1,047.05
3 yard	281.24	550.01	818.80	1,087.60	1,356.41	1,625.17
Add'l Cont.	250.30	490.68	731.71	974.81	1,214.26	1,450.39
4 yard	361.79	711.18	1,060.54	1,409.90	1,759.26	2,108.64
Add'l Cont.	324.25	637.40	949.68	1,259.36	1,575.61	1,888.18
5 yard	440.04	866.45	1,292.88	1,719.26	2,145.71	2,572.10
Add'l Cont.	415.29	817.66	1,217.89	1,619.77	2,024.64	2,432.05
6 yard	511.19	1,008.78	1,506.34	2,003.93	2,501.51	2,999.10
Add'l Cont.	482.72	953.97	1,418.91	1,890.39	2,361.47	2,826.38
8 yard	641.77	1,269.90	1,898.05	2,526.19	3,154.34	3,782.48
Add'l Cont.	608.76	1,204.55	1,800.57	2,394.58	2,981.62	3,581.60

Commercial Recycling for Drop Box and Roll Off Compactor Customers

Stops/Week	1	2	3	4	5
1 to 4 yards	\$ 67.00	\$ 133.00	\$ 200.00	\$ 267.00	\$ 333.00
5 to 8 yards	92.00	185.00	277.00	369.00	461.00

Multi-Family Recycling for Roll Off Compactor Customers

Rate per Unit \$ 3.00

SECTION 16: VIOLATIONS OF THE MUNICIPAL CODE

Solid Waste Rates continued

Bio-Medical Services Fees	Fiscal Year 2025 & 2026 Fee	
	Tub Rates per gallon	
Number of units:	20/21	35/48
1	\$81.45	\$83.25
2	\$61.85	\$63.50
3	\$54.30	\$56.00
4	\$49.35	\$51.00
5	\$46.35	\$48.00
6	\$44.35	\$46.00
7	\$41.85	\$43.50
8	\$40.40	\$42.00
9	\$37.35	\$39.00
10	\$35.85	\$37.50
11	\$34.75	\$36.50
12	\$33.25	\$35.00
13	\$32.75	\$34.50
14	\$32.00	\$33.75
15	\$31.25	\$33.00
16	\$26.30	\$28.00
17	\$26.30	\$28.00
18	\$26.30	\$28.00
19	\$26.30	\$28.00
20	\$26.30	\$28.00
60	\$17.90	\$18.75
75	\$17.45	\$18.05
90	\$12.80	\$13.10



**City of Milwaukie
10501 SE Main St.
Milwaukie, OR 97222**

503.786.7555

<http://www.milwaukieoregon.gov/finance>

COUNCIL RESOLUTION No.

A RESOLUTION OF THE CITY COUNCIL OF THE CITY OF MILWAUKIE, OREGON, REVISING FEES AND CHARGES AND UPDATING THE CONSOLIDATED FEE SCHEDULE FOR FISCAL YEARS 2025 AND 2026.

WHEREAS it is the policy and practice of the city to require the discernment and recovery of certain city costs from fees and charges levied in providing various services, products, and regulations, and

WHEREAS city staff shall periodically review of city fees and charges to recover city costs in providing services, products, and regulations, and recommend adjustments to the City Council, and

WHEREAS Milwaukie advisory boards, commissions, and committees periodically recommend adjustments to the fees and charges levied in providing services, products, and regulations, and

WHEREAS the city manager has caused a review of all city fees and charges, has received guidance from advisory boards, commissions, committees, and city staff, and has finalized the updated Consolidated Fee Schedule.

Now, Therefore, be it Resolved that:

SECTION 1. The City of Milwaukie “Fees” document included as Attachment A to this resolution is hereby adopted.

SECTION 2. This resolution supersedes previously adopted fee resolutions.

Introduced and adopted by the City Council on **June 4, 2024**.

This resolution is effective on **July 1, 2024**.

Lisa M. Batey, Mayor

ATTEST:

APPROVED AS TO FORM:

Scott S. Stauffer, City Recorder

Justin D. Gericke, City Attorney



**RS 8. A. 6/4/24
Presentation**



CITY OF MILWAUKIE

**FEE
SCHEDULE
2025-2026**

**Council Meeting
June 4, 2024**

CONSOLIDATED FEE SCHEDULE: OVERVIEW

- Would go into effect on July 1, 2024 (unless otherwise specified)
- Updated throughout the year as needed
 - Staff will aim to time updates with quarterly supplemental budget updates
- Goal is to accurately recover costs incurred by the city



SIGNIFICANT CHANGES

- Erosion control fees updated to more accurately capture costs.
- Planning fees updated to more accurately capture costs and reflect code.
- Water System Development Charges (SDCs) increased based on updated methodology. Stormwater and transportation SDCs increased 5.64% (five-year Seattle Construction Cost Index average)
- Bancroft Financing administrative charges increased from 2% to 5%.



SIGNIFICANT CHANGES

- Utility rates adjusted based on recommendations from Citizen Utility Advisory Board. Average monthly residential cost impacts:
 - Water = 1.02% increase
 - Wastewater = 1% decrease
 - Stormwater = no change
 - Streets = 5.64% increase
- Right-of-way utility license fees on electric and natural gas providers increased from 5% to 8% of gross revenue.
- No changes to solid waste rates proposed at this time. Discussion in July 2024.



FIVE YEAR GENERAL FUND FORECAST

Holding **ROW License Fees at 5%**

With the **increase in ROW License Fees to 8%** (shown in draft proposed budget)

(Amounts in Thousands: \$100 = \$100,000)	Current Fiscal Year Estimated	Current Budget		Forecast		
		*1	*2	*3	*4	*5
	FY 2024	FY 2025	FY 2026	FY 2027	FY 2028	FY 2029
OVER (UNDER) POLICY	6,496	3,281	1,222	(6,981)	(13,555)	(20,385)
TOTAL ENDING FUND BALANCE	9,071	7,235	4,773	(1,765)	(8,107)	(14,696)

(Amounts in Thousands: \$100 = \$100,000)	Current Fiscal Year Estimated	Current Budget		Forecast		
		*1	*2	*3	*4	*5
	FY 2024	FY 2025	FY 2026	FY 2027	FY 2028	FY 2029
OVER (UNDER) POLICY	6,496	3,781	2,722	(4,401)	(9,808)	(15,379)
TOTAL ENDING FUND BALANCE	9,071	7,735	6,273	815	(4,360)	(9,690)



COUNCIL STAFF REPORT

To: Mayor and City Council
Emma Sagor, Acting City Manager

Reviewed: Joseph Briglio, Community Development Director

From: Michael Osborne, Finance Director

Subject: **State Shared Revenue**

Date Written: May 23, 2024

ACTION REQUESTED

Council is asked to adopt two resolutions certifying that the city provides four or more municipal services for eligibility to receive state shared revenues and expressing the city’s election to receive state revenue sharing for the 2025-2026 biennium.

HISTORY OF PRIOR ACTIONS AND DISCUSSIONS

[April 27, 2024](#): The Budget Committee held a public hearing on state revenue shares.

[May 4, 2024](#): The Budget Committee held a public hearing on the city budget including the state revenue shares and approved the budget for City Council.

ANALYSIS

For the city to receive state shared revenue funds, the city must certify that it is eligible to receive state shared revenue funds (i.e., liquor, cigarette, and gas taxes) because it provides at least four of the mandatory municipal services during the 2025-2026 biennium.

Additionally, to receive state revenue sharing funds, the city must elect to receive state revenue sharing funds (general funds of the state) during the 2025-2026 biennium. This election is satisfied by holding public hearings of the Budget Committee and Council. At both hearings, residents can comment on the use of state revenue sharing funds.

BUDGET IMPACT

The following schedule reflects the projected revenue from the various state shared revenues that the city expects to receive and the purpose for which the revenue is utilized.

Type	FY 2025	FY 2026	Total	Fund Receiving the Revenue
Liquor Tax, Cigarette Tax and other state shared revenues	\$ 820,000	\$ 830,000	\$ 1,650,000	General Fund
State Gas Tax Revenue	\$ 1,673,000	\$ 1,673,000	\$ 3,346,000	Transportation Fund

CLIMATE, EQUITY, & WORKLOAD IMPACTS

None.

COORDINATION, CONCURRENCE, OR DISSENT

The city manager, public works director, and city engineer concur with the proposed resolution.

STAFF RECOMMENDATION

Staff recommends that Council adopt the resolutions electing to receive state sharing revenue and certifying the city's eligibility to receive state sharing revenue.

ALTERNATIVES

If Council were not to adopt the resolutions, the approved budget would need to be amended.

ATTACHMENTS

1. Resolution certifying the city's eligibility to receive state shared revenue (ORS 221.760)
2. Resolution electing to receive state revenue sharing funds (ORS 221.770)

COUNCIL RESOLUTION No.**A RESOLUTION OF THE CITY COUNCIL OF THE CITY OF MILWAUKIE, OREGON CERTIFYING THAT THE CITY IS ELIGIBLE IN THE 2025-2026 BIENNIUM TO RECEIVE STATE SHARED REVENUES BECAUSE IT PROVIDES FOUR OR MORE MUNICIPAL SERVICES.**

WHEREAS Oregon Revised Statute (ORS) 221.760 provides as follows:

Section 1. The officer responsible for disbursing funds to cities under ORS 323.455, 366.785 to 366.820 and 471.805 shall, in the case of a city located within a county having more than 100,000 inhabitants according to the most recent federal decennial census, disburse such funds only if the city provides four or more of the following services:

- (1) Police protection
- (2) Fire protection
- (3) Street construction, maintenance, and lighting
- (4) Sanitary sewer
- (5) Storm sewers
- (6) Planning, zoning, and subdivision control
- (7) One or more utility services; and

WHEREAS city officials recognize the desirability of assisting the state officer responsible for determining the eligibility of cities to receive such funds in accordance with ORS 221.760.

Now, Therefore, be it Resolved by the City Council of the City of Milwaukie, Oregon, that the city certifies that it provides the following municipal services enumerated in ORS 221.760 Section 1:

- (1) Police protection
- (2) Street construction, maintenance, and lighting
- (3) Sanitary sewer
- (4) Storm sewers
- (5) Planning, zoning, and subdivision control
- (6) Water utility service

Introduced and adopted by the City Council on **June 4, 2024**.

This resolution is effective on immediately.

ATTEST:

Lisa M. Batey, Mayor

APPROVED AS TO FORM:

Scott S. Stauffer, City Recorder

Justin D. Gericke, City Attorney

COUNCIL RESOLUTION No.

A RESOLUTION OF THE CITY COUNCIL OF THE CITY OF MILWAUKIE, OREGON, DECLARING THE CITY'S ELECTION TO RECEIVE STATE REVENUE SHARING FUNDS (GENERAL FUNDS OF THE STATE) IN THE 2025-2026 BIENNIUM.

WHEREAS the City of Milwaukie desires to receive state revenue sharing funds apportioned and distributed to the cities of the state during the 2025-2026 biennium as provided in Oregon Revised Statute (ORS) 221.770; and

WHEREAS ORS 221 .770(1)(a) requires that any city electing to receive a distribution must enact an ordinance or resolution expressing that election and file the same with the Oregon Department of Administrative Services no later than June 30; and

WHEREAS ORS 221.770 (1)(b) requires that any city electing to receive a distribution must hold at least one public hearing at which residents have the opportunity to provide written or oral comment on the possible uses of the distributions; and

WHEREAS a public hearing has been held before the Budget Committee on April 27, 2024, to discuss possible uses of the funds, and before the City Council on June 4, 2024, to obtain public input on the proposed uses of the funds.

Now, Therefore, be it Resolved by the City Council of the City of Milwaukie, Oregon, that the city elects to receive its proportionate share of the state revenues for the 2023-2024 biennium pursuant to ORS 221.770 and has met the requirement of ORS 221.770 (1) as certified in the attached certification.

Introduced and adopted by the City Council on **June 4, 2024**.

This resolution is effective immediately.

Lisa M. Batey, Mayor

ATTEST:

APPROVED AS TO FORM:

Scott S. Stauffer, City Recorder

Justin D. Gericke, City Attorney



**RS 8. B. 6/4/24
Presentation**



CITY OF MILWAUKIE

**STATE
REVENUE
SHARING
2025-2026**

**Council Meeting
June 4, 2024**

25-26 STATE SHARED REVENUE SUMMARY

Type	FY 2025	FY 2026	Total	Fund Receiving the Revenue
Liquor Tax, Cigarette Tax and other state shared revenues	\$ 820,000	\$ 830,000	\$ 1,650,000	General Fund
State Gas Tax Revenue	\$ 1,673,000	\$ 1,673,000	\$ 3,346,000	Transportation Fund



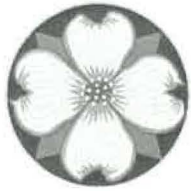

PUBLIC HEARING ATTENDANCE SIGN-UP SHEET

If you wish to have appeal standing and/or to be on the mailing list for Council information from tonight's hearing, please sign-in below.

6/4/2024

8. C. 2025-2026 Biennial City Budget and Capital Improvement Plan Adoption – Resolution

Land Use File No. (none)

NAME	ADDRESS	PHONE	EMAIL

COUNCIL STAFF REPORT

To: Mayor and City Council
Emma Sagor, Acting City Manager

Date Written: May 23, 2024

Reviewed: Joseph Briglio, Community Development Director

From: Michael Osborne, Finance Director

Subject: **Adoption of the 2025-2026 BN Budget and Capital Improvement Plan (CIP)**

ACTION REQUESTED

Council is asked to adopt the budget and Capital Improvement Plan (CIP) for the biennium commencing July 1, 2024, previously approved by the Budget Committee.

HISTORY OF PRIOR ACTIONS AND DISCUSSIONS

[February 5, 2024](#): The Citizens Utility Advisory Board (CUAB) held a meeting to discuss proposed CIP and utility rate changes.

[February 12, 2024](#): The Budget Committee held meeting to discuss proposed CIP and utility rate changes.

[April 27, 2024](#): The Budget Committee met, the proposed budget was distributed, and the budget message was presented.

[May 4, 2024](#): The Budget Committee approved the proposed budget.

ANALYSIS**2025-2026 Biennial Budget:**

The Budget Committee met and approved the 2025-2026 biennial budget, on May 4, 2024, and recommended adoption by Council.

The approved budget for the 2025-2026 biennium totals \$191,797,000 and establishes the city's tax rate of \$4.1367 per \$1,000 of assessed value for fiscal year (FY) 2025 and FY 2026 respectively, and bonded debt levy amounts for general obligation bonds as follows:

	<u>FY 2025</u>	<u>FY 2026</u>
Bonded Debt Levy	\$860,000	\$860,000

A financial summary of the approved budget and a notice of budget hearing before the Council were published in the *Lake Oswego Review* on Wednesday, May 29, 2024, according to the requirements of Oregon Local Budget Law (ORS 294.418). Council may take action to adopt the budget once the budget hearing has been held and testimony has been heard and considered.

Amendments:

Since approval of the budget, staff continued to make minor editorial and grammar edits to enhance the document. No changes have been made to the financial information presented in the April and May Budget Committee hearings.

Capital Improvement Plan:

A major part of constructing the budget starts with allocation towards large capital improvements; however, to set up a capital budget, it is necessary to have an up-to-date program that places the needed capital items on a tentative priority list for the next several years. Throughout the year and during the preparation for the biennium budget proposal, a list of projects was reviewed, updated, and revised considering the past year’s happenings. These projects are then consolidated into a plan which the city calls the CIP. Such a plan is not intended to spend more public money, but to anticipate the needs of the city so that money can be spent effectively and timely. A capital improvement may be broadly defined as a costly item that is expected to be relatively permanent. The minimum cost level will depend on the size and income of the city. For the purposes of Milwaukie, a capital project is defined as “costing more than \$10,000 and having a life expectancy of at least one year” to be considered a “capital improvement” in the CIP, to be consistent with financial reporting policies.

The CIP was presented to the Budget Committee and CUAB at meetings in February 2024, reviewing the proposed utility projects, the proposed budgets, and proposed rates. In addition to reviewing, updating, and revising the project list, staff continued to make the document more user-friendly.

BUDGET IMPACT

The proposed resolution adopts the 2025-2026 biennial budget of \$191,797,000 and appropriates \$161,069,000 in funding.

CLIMATE IMPACT

The projects and programs advanced as part of the city’s budget will be designed to support the cities carbon reduction climate resilience goals.

EQUITY IMPACT

The projects and programs advanced as part of the city’s budget will be designed to support the diversity, equity, and inclusion, particularly creating opportunities for historically disenfranchised communities.

WORKLOAD IMPACTS

There is no net increase in full-time equivalent (FTE) positions in this budget over the full biennium (some positions were reallocated throughout departments to reflect new reporting arrangements). However, service demands continue to grow in the city. Without securing new revenue streams in future budgets that allow us to grow our workforce to accommodate for this increasing demand, we may see cuts to services

COORDINATION, CONCURRENCE, OR DISSENT

The acting city manager and department directors concur with the proposed resolution. Directors and managers were integral to the budget development process. The Budget Committee approved the budget, CIP, and tax levies, and recommended Council adopt the budget.

STAFF RECOMMENDATION

Staff recommends that Council adopt the attached resolution.

ALTERNATIVES

Council may recommend further changes to the resolution to adopt the budget.

ATTACHMENTS

1. Resolution for Adopted Budget and Taxes
2. Proposed Budget as approved by Budget Committee

COUNCIL RESOLUTION No.

A RESOLUTION OF THE CITY COUNCIL OF THE CITY OF MILWAUKIE, OREGON, ADOPTING THE CITY OF MILWAUKIE BUDGET AND CAPITAL IMPROVEMENT PLAN FOR THE BIENNIUM COMMENCING JULY 1, 2024, MAKING APPROPRIATIONS, LEVYING AD VALOREM TAXES, AND CLASSIFYING LEVIES PURSUANT TO SECTION 11b, ARTICLE XI OF THE OREGON CONSTITUTION.

BE IT RESOLVED by the City Council of the City of Milwaukie, Oregon, that:

Section 1. The City Council hereby adopts the budget for the 2025-2026 biennium in the sum of \$191,797,000. The budget is now on file at the Finance Department, City Hall, Milwaukie Oregon.

Section 2. The amounts listed in the table below are hereby appropriated for the biennium beginning July 1, 2024, for the purposes stated.

General Fund - by department

City Council	\$ 294,000
City Manager	2,992,000
City Attorney	747,000
Community Development	1,274,000
Public Works Administration	3,899,000
Engineering Services	3,137,000
Facilities Management	4,497,000
Finance	3,129,000
Fleet Services	1,386,000
Human Resources	1,024,000
Information Technology	3,275,000
Municipal Court	407,000
Planning Services	1,837,000
Code Enforcement	841,000
Public, Education and Government	35,000
City Recorder	1,481,000
Library	4,718,000
Police	17,966,000
General Government:	
Department	3,004,000
Contingency	1,737,000
Appropriated for the General Fund	\$ 57,680,000

Debt Service Fund

Debt Service	\$ 2,814,000
Appropriated for Debt Service Fund	<u>\$ 2,814,000</u>

Building Fund

Building Department	\$ 2,746,000
Contingency	680,000
Appropriated for Building Fund	<u>\$ 3,426,000</u>

Construction Excise Tax Fund

Construction Excise Tax Department	\$ 625,000
Contingency	60,000
Appropriated for Affordable Housing Fund	<u>\$ 685,000</u>

Transportation Fund

Street Surface Maintenance Program Department	\$ 9,320,000
Safe Access for Everyone Program Department	16,169,000
State Gas Tax Department	11,918,000
Contingency	135,000
Appropriated for Transportation Fund	<u>\$ 37,542,000</u>

Water Fund

Water Department	\$ 18,103,000
Contingency	56,000
Appropriated for Water Fund	<u>\$ 18,159,000</u>

Wastewater Fund

Wastewater Department	23,137,000
Contingency	34,000
Appropriated for Wastewater Fund	<u>\$ 23,171,000</u>

Stormwater Fund

Stormwater Department	\$ 16,332,000
Contingency	45,000
Appropriated for Stormwater Fund	<u>\$ 16,377,000</u>

Systems Development Charges (SDC) Fund

Transportation Department	\$	550,000
Wastewater Department		320,000
Stormwater Department		345,000
Appropriated for SDC Fund	\$	<u>1,215,000</u>

Summary Totals for All Funds

Appropriated Expenditures	\$	158,321,000
Appropriated Contingency		2,748,000
Total Appropriations		<u>161,069,000</u>
Total Unappropriated		<u>30,728,000</u>
TOTAL ADOPTED BUDGET for 2025-2026	\$	<u>191,797,000</u>

Section 3. BE IT RESOLVED that the City Council of the City of Milwaukie hereby imposes the taxes provided for in the adopted budget, for fiscal years 2024-2025 and 2025-2026, at the rate of \$4.1367 per \$1,000 of assessed value (AV) for operations per fiscal year; imposes taxes for fiscal year 2024-2025 and 2025-2026 in the amount of \$860,000 for general obligation bonds, and that taxes are hereby imposed for 2024-2025 and 2025-2026 tax years upon the assessed value of all taxable property; noting that the city’s permanent tax rate of \$6.5379 is offset by Clackamas County Fire District No. 1 permanent rate of \$2.4012 for FY 2025 and FY 2026 respectively; and classified pursuant to the categories and subject to the limits of section 11b, Article XI of the Oregon Constitution as follows:

	<u>FY 2023</u>	<u>FY 2024</u>
General Government Limitation:		
Permanent Rate Tax (rate per \$1,000 AV)	\$ 4.1367	\$ 4.1367
Excluded from Limitation:		
General Obligation Bond Debt Service	\$ 860,000	\$ 860,000

Section 4. The city manager or their designee shall certify, file with, and give notice to the county assessors of Clackamas County, Multnomah County, and the Oregon Department of Revenue as required by ORS 294.458 and 310.060.

Section 5. Effective Date. This resolution will take effect upon passage.

This resolution was approved and declared adopted at a regular meeting of the City Council of the City of Milwaukie held on the 4th day of June 2024.

Introduced and adopted by the City Council on **June 4, 2024**.

This resolution is effective July 1, 2024.

Lisa M. Batey, Mayor

ATTEST:

APPROVED AS TO FORM:

Scott S. Stauffer, City Recorder

Justin D. Gericke, City Attorney



CITY OF MILWAUKIE

APPROVED BUDGET

2025-2026
BIENNIUM

Milwaukie, Oregon
July 1, 2024 – June 30, 2026



RS112

Table of Contents

BUDGET MESSAGE

City Manager’s Message	1
------------------------	---

OVERVIEW

City Overview	17
Organizational Chart	22
Budget Philosophy & Process	23
Budget Process Phases & Goals	28
Budget Calendar	30

POLICIES/TRENDS

Financial Policies	31
Governmental Accounting	45
Financial Trends	49
Outstanding Debt	57
Personnel Overview	59
Transfers	65

BUDGETS

Citywide Overall Budget	77
General Fund	79
City Council	83
City Manager	85
City Attorney	89
Community Development	91
Public Works Admin	95
Engineering Services	99
Facilities Management	103
Finance	107
Fleet Services	109
Human Resources	111
Information Technology	113
Municipal Court	117
Planning Services	119
Code Enforcement	123
PEG	125
City Recorder	127
General Government	131

BUDGETS (continued)

Library	133
Police	137
Debt Service Fund	141
Building Fund	143
Construction Excise Tax Fund	147
Transportation Fund	149
System Development Charges Fund	155
Water Fund	159
Wastewater Fund	163
Stormwater Fund	167

FORECAST

Five-Year Forecast	171
--------------------	-----

GLOSSARY

Index of Budget Terms	183
Budget Term Acronyms	195

MRC

Budget Message	199
MRC Urban Renewal Fund Budget	201
Five-Year Forecast	203

CIP

Capital Improvement Plan 2025-2030	205
------------------------------------	-----



RS114

Fiscal Years 2025 – 2026

Approved

Biennial Budget

Mayor and City Council

Lisa Batey, Mayor

Shane Abma

Adam Khosroabadi

Robert Massey

Rebecca Stavenjord

Citizen Members

Leslie Schockner, Chair

David Chitsazan

William Johnson

Mary Rowe

Sofie Sherman-Burton



CITY OF MILWAUKIE

RS115



RS116



The Government Finance Officers Association of the United States and Canada (GFOA) presented a Distinguished Budget Presentation Award to the City of Milwaukie for its fiscal years 2023-2024 biennial budget.

This award is the highest form of recognition in governmental budgeting. Its attainment represents a significant accomplishment by a governmental entity, its financial staff, and its management. This international award program was first established in 1984 to encourage exemplary budgetary practices and to provide peer recognition for government finance officers who prepare budget documents. Budget proficiency is rated in four major categories:

1. as a policy document;
2. an operations guide;
3. a financial plan; and
4. a communications device.

We believe this budget document continues to conform to program requirements, and we are submitting it to GFOA to determine its eligibility for another award. In addition to the budget award, Milwaukie Finance receives awards for its Annual Comprehensive Financial Reports (ACFR) and People's (Popular) Annual Financial Reports (PAFR), making it one of the most decorated finance agencies in Oregon.

Inquiries regarding the 2025-2026 biennial budget for the City of Milwaukie, or requests for mailing, should be directed to:

City of Milwaukie
Attn: Michael Osborne, Finance Director
10501 SE Main Street
Milwaukie, OR 97222
osbornem@milwaukieoregon.gov

This document is also available for review on the internet at www.milwaukieoregon.gov/finance



GOVERNMENT FINANCE OFFICERS ASSOCIATION

*Distinguished
Budget Presentation
Award*

PRESENTED TO

**City of Milwaukie
Oregon**

For the Biennium Beginning

July 01, 2022

Christopher P. Morill
Executive Director



Government Finance Officers Association

Certificate of
Achievement
for Excellence
in Financial
Reporting

Presented to

**City of Milwaukie
Oregon**

For its Annual Comprehensive
Financial Report
For the Fiscal Year Ended

June 30, 2022

Christopher P. Morill
Executive Director/CEO



Government Finance Officers Association

Award for
Outstanding
Achievement in
Popular Annual
Financial Reporting

Presented to

**City of Milwaukie
Oregon**

For its Annual Financial Report
For the Fiscal Year Ended

June 30, 2022

Christopher P. Morill
Executive Director/CEO

Dear Mayor, City Councilors, Budget Committee members and fellow Milwaukians,

I am pleased to present the proposed budget for the 2025-2026 biennium. This document represents the analysis and contributions of countless City of Milwaukie employees, particularly our finance team. I am deeply grateful for their hard work.

REFLECTING BACK

When looking back at Milwaukie's municipal operations over the past two budget cycles, one clear overarching theme emerges: *change*.

Since 2020, our community has experienced considerable change—both expected and unexpected. These include *challenging* changes that permanently altered expectations for city services. The city navigated the global Covid-19 pandemic, pivoting our operations to accommodate hybrid technology and evolving public health guidelines. We experienced more frequent and volatile weather emergencies due to our changing climate, with ice, smoke, and severe heat events becoming regular occurrences. We also witnessed more and more of our community members in crisis as houselessness and behavioral health challenges increased throughout the region.

Recent years have also included several *exciting* changes that were the result of intentional investment and planned innovation. The city opened a new library building in 2020, shortly before pandemic lockdown. Thanks to the Safe Access for Everyone (SAFE) program, we delivered millions of dollars and dozens of miles of street safety and mobility improvements. We broke ground on three neighborhood parks, bringing much anticipated positive change to our neighborhoods. And in the past year, we moved into a new city hall and sold its historic predecessor, the development of which promises to be a catalytic driver for Milwaukie's downtown revitalization.

Change has also come at the personnel level—which is inevitable in any dynamic organization staffed by highly qualified people. More than half of the city's department heads joined Team Milwaukie within the last three years. In April 2024, our chief of police, Luke Strait, retired following 25 years of service to the city, and former city manager, Ann Ober, took on a new opportunity in a neighboring county following 7.5 years at the city's helm.

This pace and volume of change has had a considerable impact on our financial landscape. Last budget cycle, the city was the recipient of substantial federal assistance fueled by pandemic relief programs, including the Coronavirus Aid, Relief and Economic Security Act of 2020 and the American Rescue Plan Act of 2021. These one-time injections of financial support are now largely spent. We have also completed (or are nearing the complete) use of previously earmarked funds that prior Councils dedicated to deliver major facility upgrades and infrastructure programs. We have officially closed the City Hall fund and, accounting for the

capital allocations proposed in this budget, we will have expended 87% of the 2018 bonded indebtedness for the SAFE program. As these funding sources are exhausted, however, the demand for the services they support remains. In Milwaukie like most other municipalities, the price tag to maintain the city's assets, sustain community programs, and ensure standards of livability has grown substantially. All of this has happened against a backdrop of four years of 3% or higher inflation. In sum, the cost of doing business as a city has increased significantly over the past several years, while ongoing municipal revenue streams have not kept pace.

We're at an inflection point. This biennium will see the hiring of new city leadership, the adoption of new labor contracts, and a settling in to a new normal. This proposed budget ensures we remain in a healthy financial position throughout the next two years. The biennial (BN) 2025-2026 budget totals \$191,798,000, not including the Milwaukie Redevelopment Commission (MRC) budget of \$9,246,000, which is the community's separate urban renewal authority. The proposed budget is balanced through the biennium, as required by the statutory limits of Oregon budget law.

Our forecast, however, indicates the city will need to identify more sustainable revenue streams over the biennium to avoid significant cuts to general funded services like public safety, facilities maintenance and accessibility, customer support, events and public engagement, and more beginning in fiscal year (FY) 2027.

THE ROAD AHEAD

The city's leadership takes this challenge seriously. In light of Milwaukie's tightening financial reality, this budget was developed with three "north star" objectives in mind:

Proposed BN 2025-2026 "north star" objectives



Objective 1: Stabilize our fiscal foundation

Our top priority in this budget is to stabilize our forecast through fiscally responsible management of our revenues and expenditures. We know Milwaukians are feeling the rising cost of living, and therefore only proposed increases to the consolidated fee schedule where absolutely necessary. We also utilized equity principles in rate design, proposing structures wherever possible to reduce the burden on lower-income earners. With the rate recommendations endorsed by the Citizens Utility Advisory Board (CUAB), the average

residential customer's monthly water bill would increase by 1.02% (or \$0.76), the monthly stormwater bill would stay the same, and the wastewater bill would decrease by 1.0% decrease (\$0.62). The average resident's monthly street maintenance fee would increase by 5.6% (or \$0.68), in alignment with the five-year average of the Seattle Construction Cost Index.

While we minimized rate changes wherever possible, the city does require additional general fund revenue to balance the budget and maintain general funded service levels through the biennium. To achieve this, we are proposing increasing the right-of-way (ROW) license fee on the city's electric and natural gas utilities from 5% to 8% of gross annual revenue.

On the expenditure side, city departments were directed to "hold the line" wherever possible with regards to materials and services expenditures. Materials and services represent 20% or \$32,036,000 of the overall budget before reserves. All but three departments were able to hold or reduce their materials and services budgets compared to the last biennium. The unavoidable cost increases can be seen in police, facilities, and information technology, where contractual obligations and required expenditures like 911 radios, building energy costs, and software subscriptions could not be cut. In addition, departments were asked to hold the line on staffing. There is no net increase in full-time equivalent (FTE) positions in this budget over the full biennium (some positions were reallocated throughout departments to reflect new reporting arrangements).

While our overall staff is not growing, this budget does project growth in personnel costs over the biennium based on assumed increases in employee benefit rates and salary scale adjustments through the collective bargaining process (currently ongoing with both of the city's labor unions) and market adjustments. Personnel services represent 29% or \$45,765,000 of total expenditures before reserves. Milwaukie is fortunate to have hardworking, dedicated, and passionate employees serving the city, and these personnel cost increases are critical for ensuring we can attract and retain the workforce our community deserves.

The capital budget for BN 2025-2026, described in further detail later in this document, also reflects our commitment to fiscal responsibility. Capital outlay, where many of the projects are infrastructure-related, accounts for 37% of the total budgeted expenditures at \$57,989,000. The Capital Improvement Plan (CIP) has been realistically calibrated to what we believe we can deliver and prioritizes completion of community-prioritized transportation investments as well as critical water infrastructure improvements. The CIP does, however, delay some general fund facilities improvement projects in order to preserve funding for critical, community-focused services until new revenues can be identified. Lastly, debt service represents 5% or \$8,139,000, and transfers to other funds are the remainder, 9% or \$14,478,000.

Overall, the citywide budget shows an increase in the total budget by \$11,315,000 or 6% from the previous budget.

Objective 2: Institutionalize our progress

In 2017, Milwaukie adopted a [community vision statement](#), aspiring to be a “flourishing city that is entirely equitable, delightfully livable, and completely sustainable.” This ambitious vision has driven investment over the past several budget cycles. While our challenging financial outlook is forcing a conservative, stability-focused strategy for this biennium, we have still built a budget that advances the city’s vision and institutionalizes the progress made to date.

One way we do this is by addressing Council-determined goals. As of April 2024, the City Council is focused on advancing the following adopted goals: **Equity, Justice and Inclusion; Climate Change Mitigation and Resiliency;** and **Parks Systems and Services**. Examples of progress made across each goal are provided in the pages following this budget message.

For the coming biennium, we have dedicated budget in ways that will help institutionalize the progress made in these areas and ensure that good work continues, even if new investment is focused elsewhere in future years. These institutionalizing investments include:



Investments that will help institutionalize equity, justice, and inclusion:

- Continued staffing and financial support for the equity and inclusion program (within the City Manager’s Office budget).
- Professional service dollars dedicated to developing equity metrics so we can track and report on outcomes overtime.
- Funding for annual staff and Council training on equity and inclusion-related topics.
- Creation of a multicultural community events fund, administered by the Equity Steering Committee.



Investments that will help institutionalize climate change mitigation and resilience:

- Continued staffing and financial support for the climate program (within the Public Works Administration budget)
- Continued staffing and support for the urban forest program.
- Funding to update the stormwater system plan to incorporate climate change in stormwater planning.
- Continued conversion of city fleet vehicles from internal combustion engines to electric vehicles (EVs).
- Installation of additional EV charging infrastructure (including in partnership with Portland General Electric and a 130kW solar array at the Johnson Creek Boulevard campus.
- Funding to continue the programmatic work identified and started as part of our Climate Action Plan, including the city’s urban forestry program, home energy score program, and climate-friendly policy codification.



Investments that will help institutionalize improvements to parks systems and services:

- Funding to complete the Scott, Balfour, and Bowman-Brae neighborhood park improvement projects by fall 2024.
- Funding for the next community survey and community engagement that will help further clarify community priorities for parks governance and development.

In addition to Council goals, the city finalized a staff strategic plan in February 2024 called *Milwaukie Momentum*. The intent of this plan is to provide a three-year organizational roadmap that ensures internal operations align with and help advance the community’s adopted vision. In the following departmental budget narratives, staff describe how they used the priorities and core values from *Milwaukie Momentum* to guide their budget decision making during this resource constrained time. By doing this, we help protect the progress we’ve made to date while focusing in on the areas that will give us the biggest bang for the buck.

Milwaukie Momentum: 2024-2027 Organizational Strategic Plan Priorities and Objectives

<p>Priority 1: Support Our Employees</p> 	<p>Priority 2: Work Smarter Together</p> 
<ul style="list-style-type: none"> • Objective 1.A: Retain staff and promote career development • Objective 1.B: Prioritize employee wellbeing • Objective 1.C: Train staff to meet growing and changing demands 	<ul style="list-style-type: none"> • Objective 2.A: Review and improve technology and processes to better deliver city services • Objective 2.B: Improve collaboration and communication across departments and levels of the organization • Objective 2.C: Coordinate public engagement to leverage resources and reach underrepresented voices
<p>Priority 3: Revitalize Milwaukie</p> 	<p>Priority 4: Help Milwaukians Most in Need</p> 
<ul style="list-style-type: none"> • Objective 3.A: Invest in our downtown and waterfront as part of the Urban Renewal Area • Objective 3.B: Support economic development by fostering partnerships and neighborhood hubs • Objective 3.C: Celebrate our unique community identity through city communications and events 	<ul style="list-style-type: none"> • Objective 4.A: Expand services for those experiencing crisis • Objective 4.B: Use data to prioritize investments where needs are the greatest • Objective 4.C: Build relationships with organizations serving vulnerable communities

Objective 3: Advance community priorities strategically

By focusing on stability and institutionalizing progress, this budget provides the foundation for Milwaukie to clarify priorities and plan for the future over the next two years. We propose a multi-pronged approach to accomplish this:

- **Review Council goals:** the City Council is due to update its goals in early 2025. This is a critical step to ensuring our policy and operational priorities align and help the city navigate trade-offs so future revenues are allocated to what matters most.
- **Evaluate capital investment priorities:** Staff plan to begin outreach in fall 2024 to inform the way the city allocates infrastructure investments in its CIP. This will ensure the CIP adopted in the next biennium reflects the most up-to-date priorities of the community.
- **Develop a long-term revenue stabilization plan:** The city faces a financial deficit beginning in FY 2028 unless new revenue sources are identified, or services are significantly cut. Staff plan to work with Council and the community to evaluate different revenue generating options and craft a long-term revenue stabilization strategy that keeps the city solvent further into the forecast. We also will continue efforts to streamline city expenditures and curb rapidly rising costs, including ways to reduce fees being paid by the city on credit card transactions.
- **Update the city's infrastructure financing strategy:** Council will be asked to consider and advise on whether the city should encumber additional debt to fund critical infrastructure projects. This includes a potential third tranche of debt funding to complete the SAFE program initial project list as well as potential financing for major water system improvements.
- **Begin significant investment of urban renewal funds:** The city will earmark funds in the coming biennium for significant investments in the Milwaukie Urban Renewal Area, building on the strategies in development by the MRC and the MRC Community Advisory Committee.

Staff are committed to providing regular updates throughout this biennium to ensure the city stays on track and makes progress on the critical future planning work detailed above. We will provide quarterly budget review updates to Council and align any supplemental budget adjustments with that quarterly cycle.

CONCLUSION

The city faces real budget challenges in the years ahead—and we are not alone in this. According to the 2024 “state of the cities” report from the League of Oregon Cities, 68% of Oregon Cities have seen an increase in city service demand in the last fiscal year, and more than half of all cities do not feel general fund revenues are keeping pace to cover that demand. But Milwaukie is no stranger to facing challenges head on with grit and heart. The groundwork laid over the past several years—prudent fiscal management, a clear community vision, and smart investments—puts the city in a good position to weather these choppy waters and chart a path forward.

Respectfully presented this 27th day of April 2024.

A handwritten signature in black ink, appearing to be 'ES', written in a cursive style.

Emma Sagor
Acting City Manager

EQUITY, JUSTICE & INCLUSION



The city commits to the pursuit of an entirely equitable Milwaukee by supporting the implementation of policies, procedures, practices, and training needs identified in the forthcoming [equity assessment and action] plan to lead to a city that is more responsive to, more trusted by, and more reflective of the community we serve.

(City Council Resolution No. 21-2023)



Why This Goal?

Milwaukee's 2040 vision calls for a flourishing city that is entirely equitable.

Black, Indigenous and People of Color (BIPOC) have suffered horrific inequities and discrimination throughout history, including at the hands of government

BIPOC and other marginalized groups experience persistent disparities today, including worse health outcomes, higher incarceration rates, less access to generational wealth building, othering and discrimination, and barriers to upward mobility

How is Success Measured?

<p>DIVERSE REPRESENTATION</p> <p>The racial and gender diversity of city employees should increasingly reflect Milwaukee's demographics</p>	<p>8.1%</p> <p>staff identify as BIPOC in 2023, compared to 24% of the local population</p>	 <p>up from 6.6% in 2017</p>
<p>INTERNAL COMPETENCY</p> <p>Staff should receive training on equity, inclusion and justice, and how to apply it in their work.</p>	<p>5</p> <p>staff trainings led by professional equity practitioners in 2023</p>	 <p>up from 4 in 2022</p>
<p>ORGANIZATIONAL COMMITMENT</p> <p>The city reviews and updates policies and workplans regularly with an eye to advancing equity.</p>	<p>24</p> <p>city policies updated to ensure equity and reduce bias in 2023</p>	 <p>up from 12 in 2022</p>
<p>MEASURABLE INCLUSION</p> <p>Community members and staff report feeling more welcome, seen and celebrated for their unique identities.</p>	<p><i>The city is in the process of developing performance indicators to track overtime on this topic.</i></p>	<p><i>N/A</i></p>

ACTION SUMMARY: 2023-2024

COMPLETED

- ☑ Conducted a comprehensive equity assessment of city services
- ☑ Developed a multi-year equity work plan
- ☑ Require an equity impact statement on all city council staff reports

UPCOMING

- ☐ Update the city's annual events program to support more multi-cultural activities
- ☐ Develop a youth engagement strategy
- ☐ Centralize internal communication and equity training materials

ONGOING

- ∞ Develop an equity framework for staff to apply in decision making
- ∞ Fund and hold regular equity trainings for staff
- ∞ Support monthly meetings and ongoing work of the Equity Steering Committee
- ∞ Regularly review city policies to promote equity
- ∞ Support employee resource groups for staff who identify as BIPOC, LGBTQIA+, neurodivergent or living with a disability

Building Institutional Capacity



EQUITY STEERING COMMITTEE

This committee of appointed community members will continue to meet monthly to advise the city and council on critical equity priorities



EQUITY & INCLUSION COORDINATOR

The city has created a permanent position within the city manager's office to lead internal and external equity efforts



EQUITY PERFORMANCE REPORTING

The city is developing more standard performance measures as part of its strategic plan and will begin annual data reporting, including on equity indicators



ANNUAL EMPLOYEE ENGAGEMENT REVIEWS

The city's human resources department surveys staff bi-annually to evaluate feelings of satisfaction, wellness, belonging and inclusion

FOR MORE INFORMATION, VISIT MILWAUKIEOREGON.GOV/CITYCOUNCIL/GOALS



CITY OF MILWAUKIE

STEPS TAKEN PRIOR TO 2023

City Council previously adopted equity, justice and inclusion as a goal in 2020. Actions completed prior to 2023 include:

2020 COMPLETED ACTIONS	2021 COMPLETED ACTIONS	2022 COMPLETED ACTIONS
<ul style="list-style-type: none"> ☑ Held equity listening sessions with community ☑ Created an equity and inclusion coordinator position within the city manager's office ☑ Held equity trainings for staff on critical topics, including cultural competence, implicit bias and othering 	<ul style="list-style-type: none"> ☑ Established Equity Steering Committee comprised of community volunteers ☑ Reviewed and updated Milwaukie Police Department policies and practices ☑ Updated city's language access policies addressing translation and interpretation. ☑ Helped create the Oregon Latinos in Local Government network ☑ Supported community organizers in organizing Milwaukie's first Juneteenth celebration 	<ul style="list-style-type: none"> ☑ Updated city procurement practices to make them more fair ☑ Began publishing issues of <i>The Milwaukie Pilot</i> in Spanish ☑ Held community conversation on bias at Clackamas Community College ☑ Contracted with Keen Independent Research to conduct a comprehensive equity assessment of the city ☑ Supported community Juneteenth and Pride celebrations ☑ Reviewed and revised human resources policies and procedures to promote equity and access for all ☑ Established Employee Resources Groups for staff who identify as BIPOC or LGBTQIA+

CLIMATE CHANGE MITIGATION & RESILIENCE



The city will take aggressive steps to minimize climate change and increase climate-related resilience by continuing to implement specific actions identified in the City’s Climate Action Plan (CAP) that provide the greatest impact possible.

(City Council Resolution No. 21-2023)

Why This Goal?



Climate change threatens Milwaukie’s community and environment.

Climate actions create community benefits by improving environmental health, livability and resiliency.

The community vision calls for Milwaukie to reduce and offset emissions, becoming a net-zero city by 2040 as the city’s contribution towards forestalling the worse effects of climate change.

The city-adopted a Climate Action Plan in 2018 and declared a climate emergency in 2020. These actions helped make progress, but much remains to be accomplished.

How is Success Measured?

<p>CONTINUED IMPLEMENTATION</p> <p>The city should make continued progress to implement the 53 city-led actions outlined in the Climate Action Plan.</p>	<p style="text-align: center;">47</p> <p style="text-align: center;">city-led Climate Action Plan actions either underway or complete</p>	
<p>PROGRESS TOWARDS CARBON-NEUTRALITY</p> <p>Community emissions should continue to decline annually as Milwaukie approaches net-zero electricity by 2030, net-zero building energy by 2035 and carbon neutrality by 2045.</p>	<p style="text-align: center;">265.8 MT CO₂e</p> <p style="text-align: center;">of local community emissions <i>(2020 inventory)</i></p>	<p style="text-align: center;"></p> <p style="text-align: center;">down 5% from 2016 inventory</p>
<p>TREE CANOPY</p> <p>The city should take efforts through direct planting, encouragement programs, and regulations to preserve and expand Milwaukie’s tree canopy coverage to 40% by 2040.</p>	<p style="text-align: center;">335</p> <p style="text-align: center;">trees planted through city efforts, including Arbor Day events</p>	<p style="text-align: center;"></p> <p style="text-align: center;">down from 1,362 in 2022</p>
<p>ELECTRIFICATION</p> <p>Milwaukie needs to see a significant increase in the number of buildings and vehicles powered by carbon-free electricity to meet our carbon reduction goals.</p>	<p style="text-align: center;">3,262</p> <p style="text-align: center;">Milwaukie homes powered by voluntary renewable electricity (and 57 businesses)</p> <p style="text-align: center;">31</p> <p style="text-align: center;">public EV charges installed</p>	<p style="text-align: center;">5.5</p> <p style="text-align: center;">megawatts of solar capacity from 724 solar installations in Milwaukie</p>

ACTION SUMMARY: 2023-2024

COMPLETED

- ☑ Purchased 100% carbon-free electricity from Oregon solar farms for city operations
- ☑ Launched new online permitting system for public and private tree permits
- ☑ Secured \$250,000 grant to explore building performance standards for emission reduction in existing buildings
- ☑ Installed public EV chargers at three city facilities

UPCOMING

- ☐ Incorporate climate change considerations into Natural Hazard Mitigation Plan update
- ☐ Installation of 120kW solar array at Johnson Creek campus
- ☐ Feasibility report for city-owned building decarbonization
- ☐ Updates to invasive and rare tree lists for tree code

ONGOING

- ∞ Improve tree permit processes to protect and increase canopy
- ∞ Advocate for helpful climate policy and programs in regional and state climate planning efforts
- ∞ Coordinate with PGE to expand public EV chargers on utility poles
- ∞ Continue implementation of the home energy score program
- ∞ Work with PGE on updated voluntary renewable energy product

Building Institutional Capacity



CLIMATE ACTION PLAN

The city is committed to full implementation of the CAP and will continue to seek and dedicate resources to enable this



SUSTAINABLE FUNDING

The city is exploring strategies for collecting revenue to support ongoing municipal climate efforts. These will be discussed with City Council in 2024



CODIFIED CLIMATE POLICIES

The city has adopted local policies, including private tree code, that support ongoing mitigation efforts. The city also advocates for regional, state and federal adoption of policies that support carbon reduction goals and responsible adaptation action



CITY FACILITY IMPROVEMENTS

As the city upgrades its buildings and facilities, it is investing in infrastructure like EV chargers to lower emissions from city operations

FOR MORE INFORMATION, VISIT MILWAUKIEOREGON.GOV/CITYCOUNCIL/GOALS



CITY OF MILWAUKIE

STEPS TAKEN PRIOR TO 2023

City Council previously adopted goals related to climate in 2017, 2018, 2019 and 2022. Actions completed prior to 2023 include:

<p>BUILDING ENERGY & EFFICIENCY</p> <ul style="list-style-type: none"> ☑ Implemented a residential home energy score program. ☑ Coordinated with PGE on several electrification educational events and campaigns. ☑ Advocated for regional legislation on building and utility-scale decarbonization, including adopted Clean Energy for All Act (HB 2021). ☑ Subscribed to 100% carbon-free Oregon solar electricity for city facilities and operations. 	<p>VEHICLES & FUELS</p> <ul style="list-style-type: none"> ☑ Purchased 12 EV and plug-in hybrid vehicles for city operations. ☑ Adopted renewable diesel use for city operations. ☑ Installed EV chargers across city facilities, including Electric Avenue. ☑ Adopted EV-ready code requirements for parking lots. 	<p>LAND USE & TRANSPORTATION</p> <ul style="list-style-type: none"> ☑ Adopted numerous climate and energy policies as part of the 2020 Comprehensive Plan update. ☑ Updated housing codes to encourage denser development. ☑ Implemented Safe Access for Everyone pedestrian and bikeway improvement projects. ☑ Updated public works standards to protect stormwater and flood storage.
<p>MATERIAL USE, PURCHASING & RECOVERY</p> <ul style="list-style-type: none"> ☑ Partnered with Clackamas County on food waste reduction outreach and education ☑ Used composted mulch in city projects ☑ Used low impact materials, such as pavers and permeable concrete, in city projects 	<p>NATURAL RESOURCES</p> <ul style="list-style-type: none"> ☑ Adopted a new tree code in 2019 focused on urban canopy preservation and expansion ☑ Designated a Tree City USA for seven years running ☑ Awarded Oregon Tree City of the Year in 2020 ☑ Developed a canopy analytics tool ☑ Expanded stormwater development requirements 	

IMPROVING PARKS SYSTEMS & SERVICES



The city commits to the difficult work of determining whether and under what terms to leave the North Clackamas Parks and Recreation District (NCPRD) and establish a city parks department; securing funding for that department; and engaging in a system planning process to identify community priorities for parks and recreation

(City Council Resolution No. 21-2023)

Why This Goal?

The Clackamas Board of County Commissioners, acting as the board for NCPRD, has declined to move forward with construction of Milwaukie Bay Park for more than two years.

For more than 30 years, despite being part of NCPRD, the city itself has purchased property for eventual parks development and raised the funding to develop most of the parks in Milwaukie.

City staff have estimated Milwaukie's parks have more than \$900,000 in deferred maintenance.

How is Success Measured?

<p>EQUITABLE COMMUNITY ENGAGEMENT</p> <p>The city should involve community members—particularly those underrepresented in traditional engagement—in the design and development of park improvements or plans.</p>	<p>1,073</p> <p>surveys received from community members through parks events in 2023</p>	<p>14%</p> <p>submitted by BIPOC-identifying community members</p>
<p>ADVOCACY FOR MILWAUKIE'S PARKS</p> <p>The city should seek grant funds to make critical improvements in neighborhood parks while we tackle larger questions about ongoing governance and management.</p>	<p>\$672,000</p> <p>awarded in local, regional and state grants to support parks development</p>	
<p>INVESTMENT IN PARK IMPROVEMENTS</p> <p>The city should proactively and efficiently design and construct park improvements, delivering on commitments made to the community.</p>	<p>\$3.3 MILLION</p> <p>to be invested in Scott, Balfour and Bowman-Brae parks by the end of 2024</p>	
<p>PLANNING FOR THE FUTURE</p> <p>The city should take steps to understand the community's interests and desires around parks governance to inform its decisions with regards to NCPRD.</p>	<p>55%</p> <p>of surveyed Milwaukians are willing to pay more for better parks (2023 community service)</p>	

ACTION SUMMARY: 2023-2024

COMPLETED	UPCOMING	ONGOING
<ul style="list-style-type: none"> ☑ Held 18 engagement events related to the development of Scott, Balfour and Bowman-Brae Parks ☑ Award construction contracts for Scott, Balfour, and Bowman-Brae parks ☑ Appealed county circuit judge’s opinion to further clarify the process for leaving NCPRD <i>(appeal still pending)</i> 	<ul style="list-style-type: none"> ☐ Complete development of Scott, Balfour and Bowman-Brae Parks by fall 2024 	<ul style="list-style-type: none"> ∞ Use city engagement channels to understand community priorities for parks governance and development ∞ Continue seeking clarity about the city’s relationship with NCPRD

Building Institutional Capacity



INVESTMENTS IN PARKS

The steps the city is taking today to invest in better neighborhood parks for Milwaukie are a long-term downpayment on better health, public space, and community building.



COMMUNITY RELATIONSHIPS

City staff are building relationships with stakeholders and community organizations to draw on for future parks projects and initiatives.



UNDERSTANDING PARK PRIORITIES

Questions about parks were included in the biannual community survey, to track changes in priorities, sentiment and satisfaction over time.



FUTURE PARKS GOVERNANCE

The decision to leave, stay or amend the city’s relationship with NCPRD will have a long-term impact on how Milwaukie residents engage with and influence their local park amenities.

FOR MORE INFORMATION, VISIT MILWAUKIEOREGON.GOV/CITYCOUNCIL/GOALS



CITY OF MILWAUKIE



RS134

City Overview

ABOUT MILWAUKIE

Nestled along the banks of the Willamette River and steeped in a rich history, Milwaukie enjoys the comforts of a small town while being near the heart of the Portland metropolitan area. The determination and optimistic outlook that have inspired Milwaukie residents for centuries is still felt today from the people that call it home today.

This suburban city of over 21,000 residents works to stay true to itself and the spirit of the community, even if that's unconventional at times. Woven through the fabric of the community is the value placed on ingenuity. Milwaukie prizes creativity to get things done by finding innovative solutions, and residents embrace originality to find new ideas that better the community.

Together, these strengths have contributed to the 2016 award-winning visioning process that received an outpouring of support from the community and led to the multi-year effort to overhaul the city's Comprehensive Plan, a process that concluded with adoption of new code and policy documents in spring 2022. These communal strengths can also be found in the city's robust and thriving business community. With more than 1,500 companies, including Oregon Tool, Inc., Bob's Red Mill, Sock it to Me, Dark Horse Comics, and Precision Castparts Corporation, Milwaukie is home to several of Oregon's largest and most iconic employers.

These same values drive events in Milwaukie each year. Umbrella Parade and Tree Lighting, Winter Solstice and Christmas Ships Party, Earth Day Clean-Up, Sunday Farmers Market, First

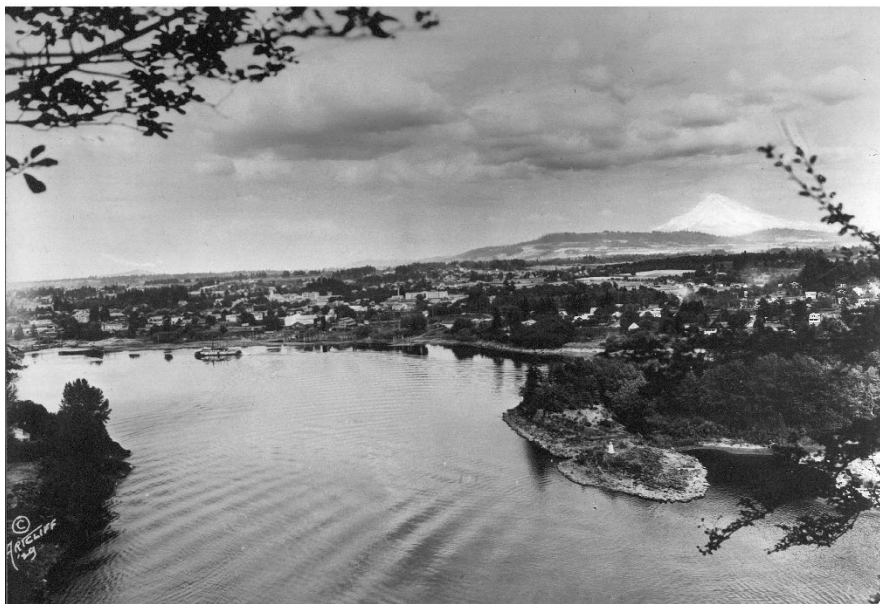

Fridays, and neighborhood concerts combine creativity and positivity to help bring the community closer together.

Like the founders before them, the people of Milwaukie know the city is destined for great things, and all are welcome to join with the community as it forges its own path to success.

HISTORY OF MILWAUKIE

The area known today as Milwaukie was once occupied by members of the Upper Chinook language group known as the Clackamas. While it is unknown whether there were ever any indigenous dwellings where Milwaukie sits today, the once marshy bay and Elk Rock Island were well known landmarks to the Clackamas and other groups that used the river for transportation. American and European explorers first visited the area in 1805 and in 1847 pioneer Lot Whitcomb arrived and named the new community after City of Milwaukee, Wisconsin, which had impressed him as he made his way west. There are various stories as to how Milwaukie came to be spelled with “ie” at the end (instead of “ee”), one of which is that the U.S. Post Office declared that the city in Wisconsin would end with “ee” while the city in Oregon would end with “ie”.

Initially, Milwaukie rivaled Willamette River neighbors Oregon City and Portland in trade and commerce as several mills were built in the hopes that Milwaukie Bay would become the region’s primary export hub for materials like lumber and flour for the gold fields of California. These initial economic enterprises bore fruit rapidly: within three years of being settled, Milwaukie was home to a post office, a newspaper, and the first side-wheel steamship built in Oregon, the *Lot Whitcomb*. In April 1851, the community was designated a “Port of Delivery” by Congress.

In 1903 Milwaukie was incorporated as a municipal corporation partially to thwart hazards related to the storage of explosives along the railroad but also to improve the dirt streets and sidewalks. The original petition, submitted in 1901, set the legislative wheels turning and on February 4, 1903, the Oregon State Legislature approved the city’s Articles of Incorporation. In 1944, Milwaukie voters adopted the Council-Manager form of government, which remains in effect to this day. Among its early successes the Milwaukie city government was one of the first in the area to establish a sewage disposal system.

By 1950, a century after being settled in the name of commerce, Milwaukie was a city of about 5,000 people. As a community on the edge of the region’s urban center, the boom years of the mid-twentieth century resulted in rapid growth and development that saw the city’s population quadruple to 20,000 by the year 2000. With the return of commuter light rail in 2015, Milwaukie is poised to continue its historic trend of growth based on easy access to transportation while preserving its reputation as a great place to live, work, and play.

In 2019, downtown Milwaukie saw its first redevelopment of a five-story building, Axletree Apartments, that features 110 units and mixed-use commercial space on the ground floor. A year later, the city opened doors to a newly constructed Ledding Library, and in 2023, the city moved into a new city hall on Main Street serving Milwaukie with consolidated services.

MILWAUKIE TIMELINE

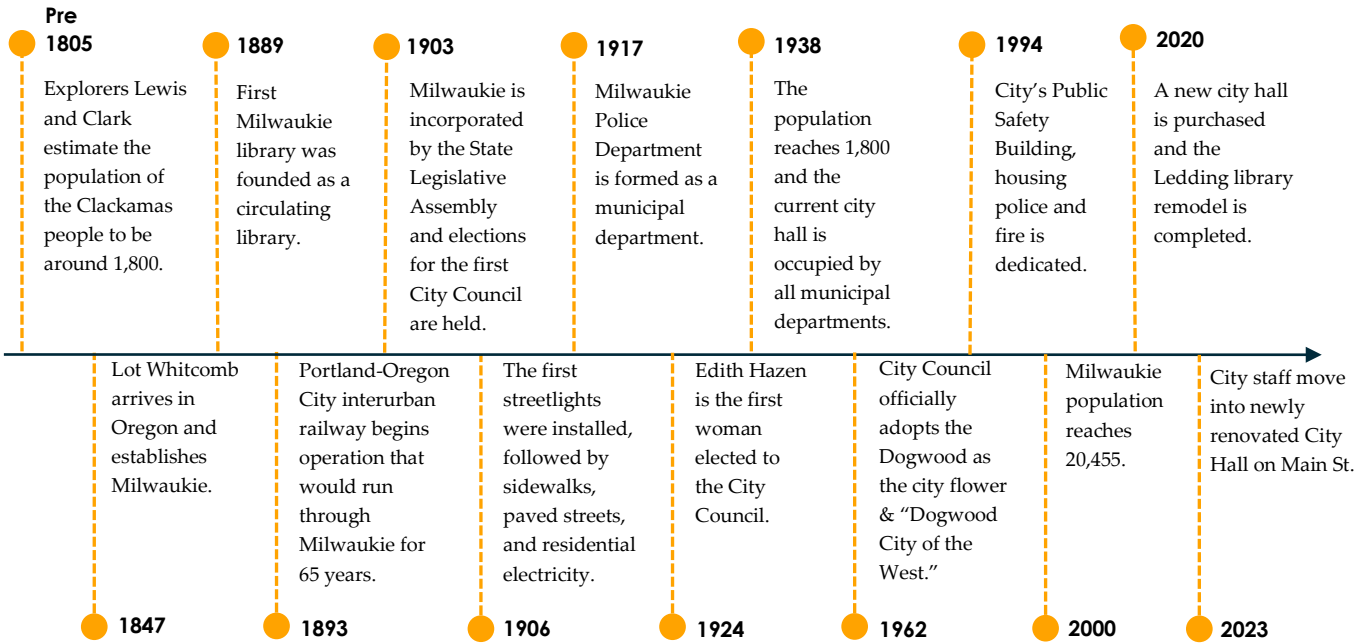

MILWAUKIE GOVERNMENT TODAY

The City of Milwaukie has a council-manager form of government. The five elected members of the City Council serve as representatives of the city's population while concentrating on policy issues that are responsive to the community's needs. All powers of the city, a municipal corporation, are vested in the Council except as otherwise specifically provided in the Milwaukie Municipal Code (MMC) and Charter. The mayor and councilors are elected at-large and serve staggered four-year terms. The mayor presides over all official and informal meetings of the Council. The city manager is hired to serve and advise the Council and the community in carrying out Council's policies.

Milwaukie City Council meets the first, second, and third Tuesday of every month, usually at city hall or another city facility. Council meetings are televised live on the city's YouTube channel (https://www.youtube.com/channel/UCRFbfqe3OnDWLQKSB_m9cAw) and within city limits on Comcast cable channel 30 and are replayed at various times during the week. They are also available online at <http://www.milwaukieoregon.gov/meetings>.

Council-Manager Form of Government



CITY SERVICES

The city's administration is committed to professionalism, efficiency, and customer service. The city operates its own police department, municipal court, water, wastewater, and stormwater utilities; and provides street operations, planning, building, engineering, community development and library services.

Clackamas Fire District #1 (CFD1) provides fire and emergency services, and the North Clackamas Parks and Recreation District (NCPRD) maintains the city's parks and provides recreational services. Milwaukie is in Clackamas County, which is headed by five commissioners based in Oregon City. Milwaukie is located within the jurisdiction of Metro, the tri-county urban services district based in Portland, and the Tri-County Transportation District of Oregon (TriMet).

CITY DEMOGRAPHICS

Statistic	Data
Population	21,375 ¹
Females	51.7% ²
Males	48.3% ²
Veterans	1,228 ²
Veterans, percent of population	6% ²
Households	9,286 ²
Persons per Household	2.25 ²
Owner Occupied Housing Unit Rate	58.60% ²
Median Value of Owner-Occupied Housing Unit	\$ 443,500 ²
High School Graduate or Higher	95.1% ²
Bachelor's Degree or Higher	38.3% ²
Median Household Income	\$ 78,676 ²
Persons in Poverty, percent	6.8% ²
Land Area in Square Miles	4.98 ²
Population per Square Mile	4,242 ²
Bond Rating	Aa2 ³
City Maintained Roads	160 Lane Miles ⁴
Building Permits Issued	288 ⁴
Sewer Miles	79 ⁴
Water Lines Maintained	99 ⁴
Number of Traffic Citations	1,811 ⁴
Avg. Library Circulation/Capita	14.84 ⁴
Unemployment Rate - Clackamas County	3.60% ⁵
City Employees	150.96 ⁶
City Property Tax Rate	\$4.0540/\$1,000 TAV ⁶
City Bonded Debt Tax Rate	\$0.3432/\$1,000 TAV ⁶
Total Property Tax Rate	\$4.3972/\$1,000 TAV ⁶
City Share of Total	20% ⁶

Source: ¹ Portland State University Population Reports/League of Oregon Cities (LOC)
² United States Census Bureau
³ Moody's Investor Services
⁴ City of Milwaukie Departments
⁵ State of Oregon Employment Department – Clackamas
⁶ Clackamas County Taxing District Rates

2024 ORGANIZATIONAL CHART

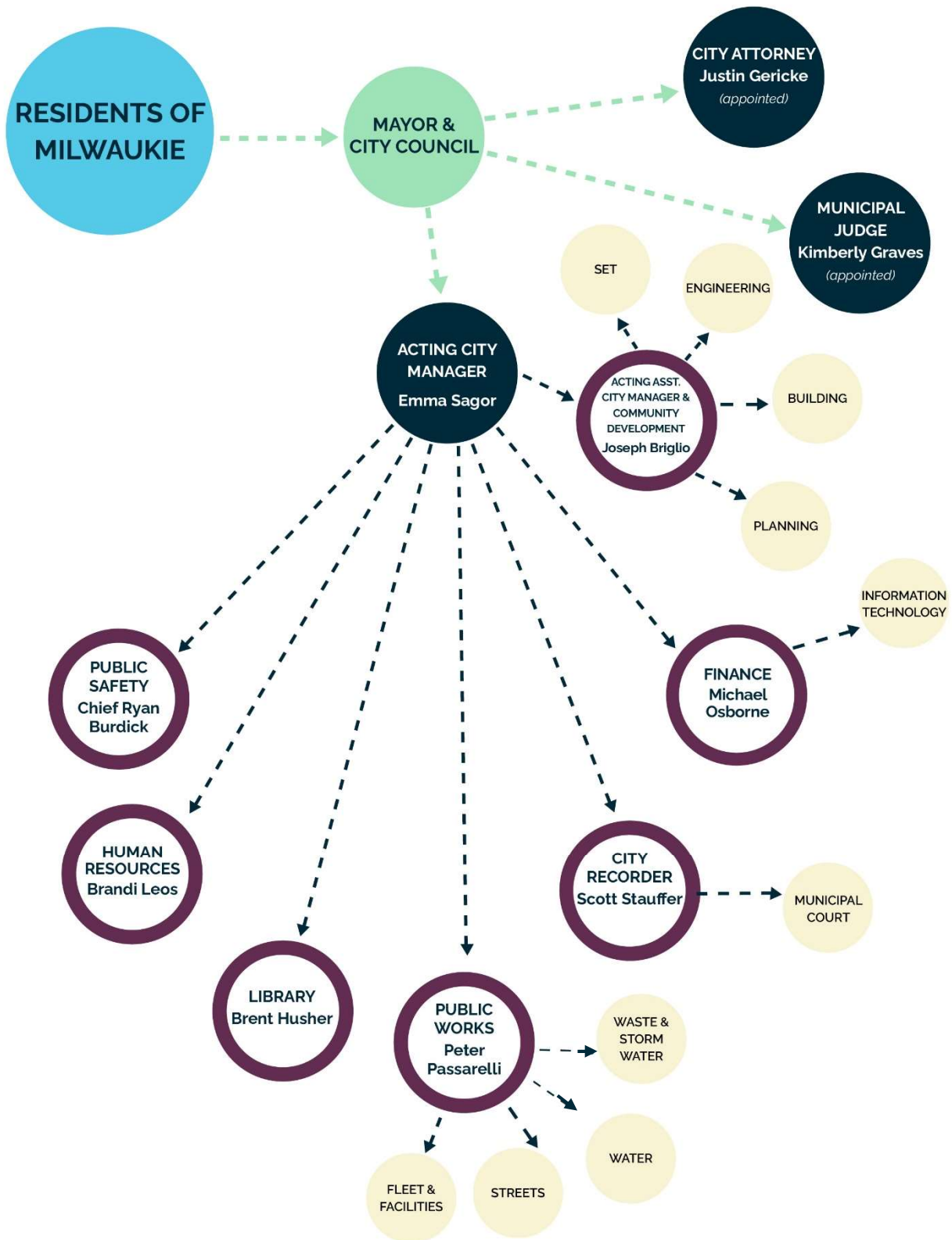

Budget Philosophy & Process

MILWAUKIE'S BUDGET PHILOSOPHY

Municipal budgets serve several important functions. In addition to laying out a basic spending plan for the city and allocating resources to meet the diverse needs of the community, Milwaukie's budget:

- Represents a principal policy and management tool for the city's administration, reflecting and defining the annual work program;
- Provides a framework for the city to accomplish its vision; and
- Reflects core city values of customer service, respect, integrity, collaboration, and innovation.

The city takes seriously its responsibility to the community as a steward of public funds, which is likewise reflected in its philosophy and approach to the budget process. The city holds itself to the standard of providing high-quality services at a reasonable cost. The city also prides itself on being a progressive community, willing to challenge the status quo and operate on the "cutting edge" of local government best practices. City staff have accepted these interrelated challenges, developing the budget within the context of searching for creative solutions for the efficient and effective delivery of city services. As such, the budget:

- Is based on timely, consistent, and clearly articulated policies;
- Is realistic and includes adequate resources to meet assigned work programs;
- Is a cooperative, citywide effort grounded in teamwork, excellent communication, community outreach, and a commitment to excellence; and
- Emphasizes measures to improve the productivity and effectiveness of service delivery to residents.

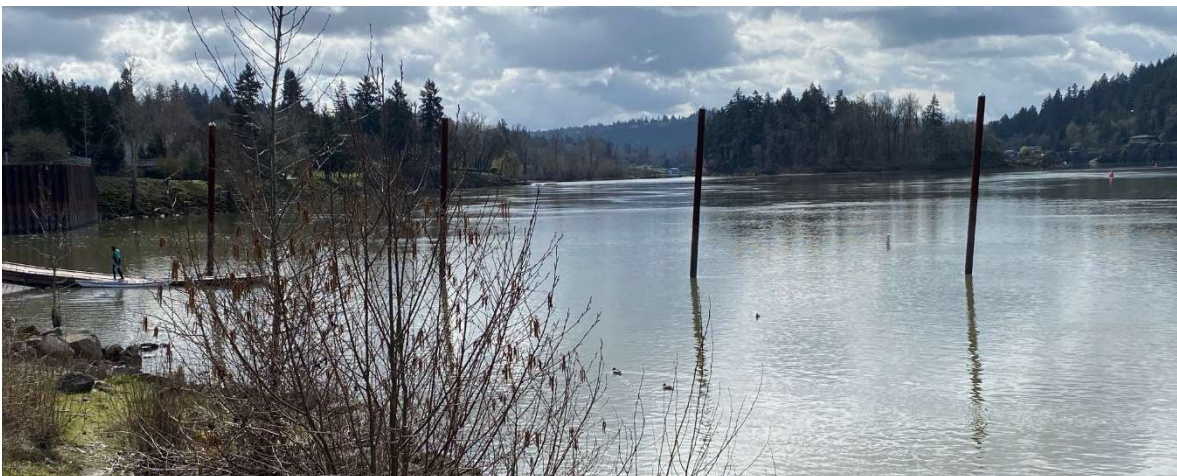

MILWAUKIE'S BUDGET PROCESS

The City of Milwaukie prepares and adopts a budget in accordance with its City Charter and Oregon Revised Statute (ORS) 294.305 through 294.565. The budget is presented in fund and department categories for a set period. Over-expenditures in any category are prohibited and unexpended budget appropriations lapse at the end of the biennium (or budget period).

Under the city's expenditure limitation, total expenditures cannot exceed the appropriation budget. The budget can be amended during the biennium through adoption of a supplemental budget. Supplemental budgets are adopted using public hearings when necessary and cannot extend beyond the end of the biennium during which they are submitted.

The city manager has responsibility for management of the overall city budget and maintaining budgetary control at the approved appropriation level. Ongoing review and monitoring of revenues and expenditures is performed by operating department directors and oversight by the finance team.

BUDGET AMENDMENTS

The budget may be amended through adoption of a supplemental budget. Supplemental budgets are adopted through a similar process used for the regular budget (including the use of public hearings), when necessary, and must not extend beyond the end of the budget period during which they are submitted. Supplemental budgets cannot be used to authorize a tax levy.

Transferring appropriations occur when an adopted budget has no authority to make certain expenditures or when revenues are received for which the city had no prior knowledge. In those cases, it is possible to use a budget transfer to authorize expenditures and/or appropriate additional revenues in the current budget period.

BUDGET COMMITTEE

The Budget Committee is comprised of the city's governing body (the City Council) and an equal number of legal voters (citizen members) appointed by the City Council. Accordingly, Milwaukie has ten Budget Committee members, and votes of all members are equal. State law (ORS 294.336) mandates a budget committee for all Oregon local governments. The Budget Committee meets periodically throughout the year to review budget and financial information and the first review of the budget occurs when the proposed budget is presented by the city manager to the committee; at that time, the budget is publicly available, and the committee begins their review of the proposed budget. The committee may approve the proposed budget as presented or change part or all of it prior to final approval.

After notices and publications are filed according to local budget law, the approved budget is forwarded to the Council for formal adoption prior to June 30.

BASIS OF BUDGETING

All city funds are budgeted using the modified accrual basis of accounting in accordance with budgetary accounting practices. In the modified accrual basis of accounting, revenues are recognized when they become measurable and available, and expenditures are recognized when a liability is incurred.

Measurable means that the dollar value of the revenue is known. Available means that it is collectible within the current period or soon enough after the end of the current period to pay for liabilities of the current period.

Significant revenues considered measurable and available under the modified accrual basis of accounting are property taxes, franchise fees, and assessment lien installments received within 60 days of the end of the fiscal year. Expenditures are recognized when the liability is incurred, except for interest on general long-term obligations which is recorded when due.

BASIS OF AUDITING

The Annual Comprehensive Financial Report (ACFR) is the annual audited report that accounts for the city's finances based on generally accepted accounting principles. Generally Accepted Accounting Principles (GAAP) is defined as conventions, rules, and procedures necessary to describe accepted accounting practice at a particular time.

The modified accrual basis of accounting, a GAAP-approved method, is also used in the audit for all funds except for the proprietary fund types (i.e., water, wastewater, and stormwater funds). The ACFR uses the full-accrual method of accounting for proprietary funds. The audit document shows all city funds on both a budgetary and GAAP basis for comparison purposes.

BUDGETING IN THE STATE OF OREGON

ORS Chapter 294.311, paragraph 5 defines a budget as:

“A plan of financial operation embodying an estimate of expenditures for a given period or purpose and the proposed means of financing the estimated expenditures.”

Local budget law for local governments is set out in ORS 294.305 to 294.565. Chapter 294.321 defines the six major purposes of local budget law:

“To establish standard procedures for the preparation, presentation, administration and appraisal of budgets of municipal corporations;

To provide for a brief description of the programs of a municipal corporation and the fiscal policy which is to accomplish these programs;

To provide for estimation of revenues, expenditures and proposed taxes;

To provide specific methods for obtaining public views in the preparation of fiscal policy;

To provide for the control of revenues and expenditures for the promotion of efficiency and economy in the expenditure of public funds; and

To enable the public, taxpayers and investors to be apprised of the financial policies and administration of the municipal corporation in which they are interested.”

BIENNIAL BUDGETING

A biennial budget period is a 24-month period beginning July 1 and ending June 30 of the second succeeding year. For this biennial budget, the period commences July 1, 2024, and ends June 30, 2026.

OREGON BUDGET LAW RELATED TO BIENNIAL BUDGETING

Local governments may budget either on a one-year or a two-year cycle. The governing body may, by ordinance, resolution, or charter, provide that the budget be prepared for a biennial period.

In brief, the differences between fiscal year budgeting and biennial budgeting are:

- Members of a Budget Committee reviewing a biennial budget are appointed to four-year terms. The terms of the members should be staggered so that one-fourth of the terms end each year.
- The budget estimate sheets containing estimated resources and expenditures in a biennial budget must show:
 - Actual expenditures for the two budget periods preceding the current budget period. Illustrating the estimated expenditures for the current budget period, and the estimated expenditures for the ensuing budget period.
 - The summary of the budget as approved by the Budget Committee that is published along with the notice of the budget hearing will show the proposed budget for the two-year biennium.
 - If a taxing district adopts biennial budgeting, the Budget Committee must approve the amount or rate of ad-valorem property taxes for each year of the biennium.
- After the Budget Committee approves a biennial budget and before the budget is adopted, the governing body (the City Council) may not increase the amount of estimated expenditures for the biennium in any fund by more than \$10,000 or 10 percent, whichever is greater, and may not increase the amount or rate of the tax levies approved by the Budget Committee for either year of a biennial budget unless the amended budget document is republished and another budget hearing is held. Once the budget is adopted, the tax amount cannot be increased in the second year.

Oregon Budget Law Related to Biennial Budgeting (continued)

- If a city adopts a biennial budget, then after the budget hearing and before the June 30 that precedes the start of the budget period, the governing body (City Council) must pass a resolution or ordinance to adopt the budget and make appropriations for the ensuing biennium. The governing body must also pass a resolution or ordinance to levy and categorize property taxes for each year of the ensuing biennium.
- Whether a budget is for a fiscal year or for a biennium, certification of property tax levies and a copy of a resolution or ordinance levying and categorizing taxes for the ensuing year must be submitted to the county assessor every year by July 15.



BUDGET PROCESS PHASES & GOALS

Phase 1

The city's budget officer (city manager) is responsible for presenting a proposed budget that is balanced and reflects the financial plan for funding all the programs and services planned for the budget period. The budget officer must prepare the proposed budget in a format prescribed by the Oregon Department of Revenue (DOR), meeting the requirements set out in state law.

Goals: conducting a Council goal setting process; balancing the budget; funding programs, services, and goals; strategic financial planning; preparing a clean, concise, and easy-to-read budget that communicates well to citizens.

Phase 2

The Budget Committee reviews and approves the budget. The committee reviews the proposed budget, listens to comments from citizens, considers any changes, and then approves the budget. Special public notices are required before the committee's first meeting.

Goals: Accuracy in current year financial estimates; prudent financial forecasting; analyses, and review; citizen input; and tax rate determination.

Phase 3

The City Council adopts the budget and certifies property taxes to the county tax assessor. This phase includes a special hearing of the governing body and specific public notices, including a summary of the approved budget. Special forms must also be used to notify the county assessor of the local government's property tax levy.

Goals: Transparent budget process; encourage public participation; certify tax rate; formal adoption of funding for city services prior to July 1.

Phase 4

This phase occurs during the budget period when the local government is operating under the adopted budget. This phase includes changes to the adopted budget. Changes to the adopted budget must be made before additional money is spent.

Goals: Responsible budget management; monitoring and review; reporting to citizens; budget updates and changes.

PERFORMANCE MEASURES AND INDICATORS

Budgets are more than just allocations of dollars – they are investments intended to deliver outputs and outcomes desired by decision makers and the community.

One way to evaluate if these investments are successful is through performance measurement. By establishing metrics of success and tracking change over time, we get a better sense of how funds are being used, what is working or not, and where further investment may be needed. Throughout this document, performance measures are included for each city department.

Measuring performance *well* requires careful consideration of what we are trying to evaluate, why, and how we can gather the data to do so. In 2024, the city adopted a three-year organizational strategic plan, *Milwaukie Momentum*, to align Milwaukie’s community vision with a clear operational roadmap for the 150 individuals who work for the city.

Part of this strategic plan is a comprehensive refresh of our performance measurement approach. For this biennium, staff have been asked to align their departmental performance measures with the five core values called out in *Milwaukie Momentum*: accountability, accessibility, efficiency, collaboration, and equity.

Over the next year, the city will work on refining its indicator list to ensure we are tracking data that best helps assess progress on these values as well as Team Milwaukie’s vision and mission statements. Our goal is that by the next biennium, the performance measures in the budget will help tell an overarching story of how we are doing toward implementing Milwaukie’s vision and where we need to lean in to do more.

TEAM MILWAUKIE

VISION
We are a diverse and resilient city government, delivering effective public services that make our community great.

MISSION
We serve as stewards of our living and built environment to help create a safe and welcoming community for all.

VALUES
We strive to be:

- ACCOUNTABLE** we build trust through transparency and taking responsibility
- ACCESSIBLE** we are responsive and remove barriers to participation
- EFFICIENT** we use resources wisely to deliver work effectively
- COLLABORATIVE** we work together, seek multiple perspectives and lead with empathy
- EQUITABLE** we acknowledge history, meet people where they are and reduce disparities

Budget Calendar

DECEMBER 2023 - JANUARY 2024

- Hold informal department discussions
- Preliminary budget requests are submitted by staff

JANUARY AND FEBRUARY 2024

- Budget requests compiled and reviewed with the city manager and department heads
- Budgetary constraints/requirements are identified and refined
- Budget Committee and Citizens Utility Advisory Board (CUAB) meetings to discuss the city's Capital Improvement Plan (CIP)

MARCH 2024

- Continued budget review with departments

APRIL 2024

- CUAB reviews utility funds and votes on rate recommendations for City Council's consideration
- Consolidated Fee Schedule is discussed with City Council
- Final preparation and departmental review of draft budget tables
- Finance team performs final review, reconciliations, and prints proposed budget and CIP
- Advertise notice of state revenue sharing uses
- Budget Committee meetings advertised:
 - Saturday, April 27, 2024
 - Saturday, May 4, 2024
 - Saturday, May 11, 2024, *if needed*
- City Manager presents budget message and the budget at the first meeting

MAY 2024

- Budget Committee discusses, receives public comment, deliberates, and approves the budget to City Council
- Budget is updated to reflect changes by the Budget Committee
- Financial Summary and Notice of Budget Hearing are prepared and published

JUNE 2024

- City Council passes resolutions for state revenue sharing eligibility and proposed uses
- City Council holds budget hearing and adopts the budget resolution, makes appropriations, and declares tax rate and bond levies
- City Council adopts CIP and Consolidated Fee Schedule

JULY 2024

- Adopted budget goes into effect July 1
- Budget and property tax certification submitted to county by July 15

Financial Policies

PURPOSE

The City of Milwaukie is committed to responsible fiscal management through financial integrity, prudent stewardship of public assets, planning, accountability and full disclosure. The broad purpose of these Financial Policies is to enable the city to achieve and maintain a long-term stable and positive financial condition. These policies are adopted by the City Council as the basic framework for overall financial management of the city, to guide day-to-day and long-range fiscal planning and decision making, and to achieve the following general financial goals:

1. Provide an adequate financial base to sustain the desired level of municipal services to maintain the social well-being and physical conditions of the city.
2. Deliver cost effective and efficient services to citizens.
3. Provide and maintain essential public facilities, utilities, and capital equipment.
4. Protect and enhance the city's credit rating to obtain the lowest cost of borrowing and assure taxpayers and the financial community that the city is well managed and financially sound.
5. Provide the financial stability needed to navigate through economic downturns, adjust to changes in the service requirements of the community and respond to other changes as they affect the city's residents and businesses.
6. Adhere to the highest standards of financial management and reporting practices as set by the Government Finance Officers Association (GFOA), the Governmental Accounting Standards Board and other professional standards.
7. Fully comply with finance related legal mandates, laws and regulations.

To achieve these goals, fiscal policies generally cover areas of revenue management, operating and capital budgeting, financial planning and forecasting, investment and asset management, debt management, accounting and financial reporting, reserves and internal controls. These policies are reviewed biennially by management, the Budget Review Board, and City Council and amended as necessary, as part of the budget process.

REVENUE POLICIES

1. The city will strive for and maintain diversified and stable revenue sources to prevent undue or unbalanced reliance on any one source of funds. Revenue diversity will also reduce risk to the city from short-term fluctuations in any one revenue source.
2. One-time revenues will be used only for one-time expenditures. The city will minimize using temporary revenues to fund continuing programs and services.
3. The city will maximize the use of service and user charges in lieu of ad valorem taxes and subsidies from other city funds, for services that can be identified and where costs are directly related to the level of service provided. The City Council may establish fees at less than “full cost recovery” when deemed in the public interest. The city will periodically and systematically review user fees and charges to consider the effects of additional service costs and inflation.
4. Unless prohibited by law, city fees may be deferred or waived by the city manager or City Council action when it can be demonstrated that a direct public benefit will be obtained. In addition, the City Council may direct that city fees, e.g., system development charges, building permit fees, planning fees, be paid on behalf of applicants and City Council’s action will include a determination of the source of funds to pay such fees. Fees that are deferred or waived by the city manager exceeding \$1,000 will be communicated to the Council.
5. All fees, charges or assessments that are deferred for later payment will be evidenced by a written promissory note or agreement. The city may charge periodic interest, processing fees and additional interest and penalties for delinquencies as appropriate.
6. System development charges shall be established to fund the costs of improvements to service additional increments to growth such as street, water, wastewater and storm water facilities and infrastructure.
7. Water, Wastewater and Stormwater Funds will be self-supporting through user fees. Utility rates will be established to fully recover costs, including operation, administration, replacement of assets, capital expansion, with consideration given to return on investment and existing and or anticipated debt to insure a debt coverage ratio of no less than 1.50.
8. Fee adjustments will be based on five-year financial plans that will be reviewed and updated annually.

Revenue Policies (continued)

9. The city manager (or designee) shall approve all grant applications before submission. Additionally, all potential grants that require matching funds, on-going resource requirements, include new or additional continuing compliance requirements shall be evaluated and considered before submittal of the application. The City Council will be provided with the evaluation and the request for their acceptance of the grant.
10. Revenues will be estimated realistically and prudently. Revenues of a volatile nature will be estimated conservatively. The city will estimate its revenues by an objective, analytical process using best practices as defined by the Government Finance Officers Association.
11. Charges for services shall accurately reflect the actual or estimated costs of providing a specific service. The cost of providing specific services shall be recalculated periodically and the fee adjusted accordingly.
12. The city shall pursue an aggressive policy for collecting delinquent accounts. When necessary, the city shall use such methods as small claims courts, collection agencies, liens to enforce collection. The city may impose late fees and penalties.

BUDGET POLICIES

1. The city will prepare a budget with the participation of all departments that incorporate GFOA recommendations relative to budgeting for results and outcomes.
 - a. *Determine how much money is available.* The budget should be built on expected revenues including base revenues, any new revenue sources and the potential use of fund balance.
 - b. *Prioritize results.* The results or outcomes that matter most to citizens should be defined. Elected leaders should determine what programs are most important to their constituents.
 - c. *Allocate resources among high priority results.* The allocations should be made in a fair and objective manner.
 - d. *Conduct analysis.* Determine what strategies, programs, and activities will best achieve desired results.
 - e. *Budget available dollars.* The objective is to maximize the benefit of the available resources to the most significant programs and activities.
 - f. *Set measures of annual progress, monitor and close the feedback loop.* These measures should spell out the expected results and outcomes and how they will be measured.

Budget Policies (continued)

- g. *Check what actually happened.* This involves using performance measures to compare actual versus budgeted results.
 - h. *Communicate performance results.* Internal and external stakeholders should be informed of the results in an understandable format.
2. All budgetary procedures will conform to existing state regulations. Oregon budget law requires each local government to prepare a balanced budget and Oregon Administrative Rules state: 1) the budget must be constructed in such a manner that the total resources in a fund equal the total of expenditures and requirements for that fund, and 2) the total of all resources of the entity must equal the total of all expenditures and all requirements for the entity.
 3. The budget process will be coordinated so that major policy issues and department goals and objectives are identified and incorporated into the budget. Additionally, the Budget Committee as established by its charge, shall review the budget of selected departments and/or city functions and shall make recommendations on service levels and the appropriate budget resources necessary to achieve that service level, consistent with its Council approved annual work plan to the full Budget Committee.
 4. A cost allocation plan will be developed and incorporated into the city budget. The cost allocation plan will be the basis for distribution of general government and internal service costs to other funds and capital projects.
 5. Unless otherwise authorized by City Council, general fund unrestricted revenues shall not be assigned for specific programs, activities or services.
 6. The City Council shall adopt the budget at the fund, departmental or program level as a total dollar amount for all appropriations except contingency, unappropriated ending fund balance and reserves, which shall be stated separately, in accordance with local budget law.
 7. At a minimum, a mid-year review process will be conducted by the city manager in order to address any necessary adjustments to the adopted budget.
 8. The city will submit the adopted budget document to GFOA to obtain the Award for Distinguished Budget Presentation.
 9. A budget calendar will be prepared detailing the key elements in the development of the budget.

EXPENDITURE CONTROL POLICIES

1. Expenditures will be controlled through appropriate internal controls and procedures. Management must ensure expenditures comply with the legally adopted budget. Each department, division manager or director will be responsible for the administration of his/her department/division budget. This includes accomplishing the goals and objectives incorporated into the budget and monitoring each department/division budget for compliance with spending limitations.
2. The city manager will administer expenditure control at the category level and program or divisional level. Additionally, the city manager may give authorization to mandate this level of control down to any line-item level. Expenditures anticipated to be in excess of these levels require approval of the city manager. All transfers of appropriations will be approved in accordance with local budget law.
3. All purchases of goods and services must comply with the city's purchasing policies, guidelines and procedures and with State laws and regulations.
4. All compensation planning and collective bargaining will include analysis of total cost of compensation, which includes analysis of salary increases, health benefits, pension contributions, and other fringe benefits. The city will only propose operating personnel costs that can be supported by continuing operating revenues.
5. City staff are to make every effort to control expenditures to ensure city services and programs provided to its citizens and taxpayers are cost effective and efficient. Expenditures that will reduce future costs will be encouraged.

CAPITAL IMPROVEMENT INVESTMENT POLICIES

1. A Capital Improvement Plan (CIP) encompassing all city facilities, including utilities infrastructure, buildings and major equipment and vehicles, shall be prepared and updated periodically as needed. A public process will be utilized to consider public testimony on the CIP, including review and approval of the CIP by the Citizens Utility Advisory Board (CUAB), Budget Committee, and the City Council. The CIP will be incorporated into the city's budget and long-range financial planning processes and as such its biennial review and approval is anticipated to occur concurrently with the budget process.
2. Projects included in the CIP shall describe the need for the project, the scope of work, total cost estimates, future operating and maintenance costs and how the project and future operations and maintenance will be funded.

Capital Improvement Investment Policies (continued)

3. An objective process, e.g., a rating matrix that includes but is not limited to neighborhood association support for projects within or directly or indirectly impacting a neighborhood association, public safety considerations, engineering, operations, connectivity, inter-departmental and/or inter-governmental commitments or requirements, and funding availability, will be established to evaluate and rank CIP projects with respect to each utility and to the overall needs of the city. The ranking of projects will be used to allocate resources to ensure projects are completed effectively and efficiently.
4. Changes to the CIP such as addition of new projects, significant change to the scope of the project or reprioritization of projects will require city manager or Council approval.
5. The city will maintain its physical assets at a level adequate to protect the city's capital investment and to minimize future operating maintenance and replacement costs. The city recognizes that deferred maintenance increases future capital costs, thus placing a burden on future residents. Therefore, the CIP will include an orderly and systemic replacement of capital facilities and equipment.
6. The city will establish and fund infrastructure and building reserves adequate to sustain each utility and the city's building facilities. The city will also establish major repairs and replacement reserves to provide stable funding of major repairs and replacements. The reserves will be included and identified as separate components of fund balance in the various funds.
7. The city will utilize "pay-as-you-go" funding for capital improvement expenditures considered recurring, operating or maintenance in nature whenever possible. The city may also utilize "pay-as-you-go" funding for capital improvements when current revenues and adequate fund balances are available or when issuing debt would adversely affect the city's credit rating or debt terms are unfavorable relative to the benefits derived from the capital improvement.
8. The city will consider the use of debt financing for capital projects and equipment under the following circumstances:
 - a. When the use of debt will result in total project cost savings that exceed borrowing costs.
 - b. When the project's useful life will exceed the terms of the financing.
 - c. When resources are deemed sufficient and reliable to service the long-term debt.
 - d. When market conditions present favorable interest rates for city financing.
 - e. When the issuance of debt will not adversely affect the city's credit rating.

FINANCIAL PLANNING POLICIES

1. The finance director (or designee), collaborating with other departments, will prepare a Five-Year Financial Forecast for each fund to promote responsible planning for the use of resources. The long-term financial plan will include projected revenues, expenditures and reserve balances for the next five years.
2. The city's financial plan should be strategic, reflecting the City Council and community priorities for service while providing resources that fund desired service levels.
3. Long-term projections of revenues and expenditures will be based upon disclosed assumptions, and prepared consistent with best practices established by GFOA.
4. The Five-Year Financial Forecast will be integral to the development of the budget and will be included in the proposed budget presented to the Budget Committee.

ECONOMIC DEVELOPMENT FUNDING POLICIES

1. The city may utilize economic development incentives to encourage value-added development and accrue public benefits to the City of Milwaukie. Public benefits may include but are not limited to, the following:
 - a. A benefit that materially enhances the financial position of the city by increasing its employment base or assessed valuation.
 - b. A contribution to the basic infrastructure of the city that is greater than that which would be required of the development alone.
 - c. A benefit that increases access to other public services.
2. Economic development incentives may include formation of improvement or redevelopment districts, reimbursement, deferral of certain fees and charges, use of discount lease rates or other forms of financial incentives. All such incentives will be evaluated as to the costs, risks and level of benefit as well as the financial impact of such incentives on the city's operating and capital budgets.
3. The fiscal impact evaluation will be presented to City Council along with the city manager's recommendation. Council shall make the final decision concerning proposed economic development incentives including any repayment of incentives if performance requirements are not met.
4. Funding for economic development incentives must be identified before approval of all such incentives.

Economic Development Funding Policies (continued)

5. A development incentive shall not be provided if the development does not provide sufficient public benefit or if the cost and risks to the City will have a materially adverse impact on the city's finances or operations.

PENSION AND RETIREMENT FUNDING POLICIES

1. All current pension liabilities shall be funded on an annual basis.
2. The city does not pay for any portion of retiree health insurance premiums except in a limited number of cases as grandfathered in under a previous policy. A retiring employee may be able to purchase City provided benefits if the person meets the eligibility requirements.

CASH MANAGEMENT AND INVESTMENT POLICIES

1. The finance director (or designee) shall invest all city funds according to four criteria, in order of their importance: (1) legality, (2) safety, (3) liquidity, and (4) yield.
2. The city shall maintain investments in accordance with Oregon Revised Statutes (ORS) 294.805 to 294.895 and comply with a written Investment Policy (see appendix) that has been approved by City Council.
3. The city will consolidate or pool cash balances from various funds for investment purposes and will apply interest earned to operating funds based on their respective share of the pool.
4. The city's investment securities will be protected through third party custodial safekeeping.

ACCOUNTING AND FINANCIAL REPORTING POLICIES

1. The city manager (or designee) shall present fiscal policy and changes to fiscal policies to the City Council. Such fiscal policies and changes in policies shall be approved by the City Council.
2. The city will comply with the following accounting and reporting standards:
 - a. Generally Accepted Accounting Principles (GAAP) developed by Governmental Accounting Standards Board;
 - b. Government Accounting, Auditing and Financial Reporting standards prescribed by the GFOA;

- c. Government Accounting Standards, issued by the Comptroller General of the United States;
 - d. Oregon Revised Statutes relating to municipal finance; and
 - e. U.S. Office of Management and Budget (OMB) Circular A-133.
2. Monthly financial reports comparing actual to budgeted expenditures will be prepared timely by finance staff. Reports will be distributed to city management. Significant budget to actual variances will be identified and explained. If an additional appropriation is anticipated, such shall be noted.
 3. Quarterly Financial Report (Report) comparing actual to budgeted revenues and expenditures will be prepared as of September 30, December 31, March 31 and June 30. The Report will be posted with the agenda for the budget committee meeting no later than one week before the scheduled meeting or the day before or after a holiday. A tentative meeting schedule will be set by the Budget Committee during the first quarter meeting of the fiscal year. Typically, committee meetings will be scheduled for the 3rd week of the 2nd month after the end of the quarter unless a majority of the committee agrees in advance to alter the schedule when needed. The Budget Committee will review the Report at its quarterly meeting. The Report will also be posted to the finance page of the city's website.
 5. A system of internal controls and procedures will be maintained to provide reasonable assurance of the safeguarding of assets and proper recording of financial transactions and compliance with applicable laws and regulations.
 6. In accordance with state law, a comprehensive financial audit including an audit of federal grants will be performed annually by an independent public accounting firm with the objective of expressing an opinion on the city's financial statements and assessing the accounting principles used and evaluating the internal controls in place.
 7. The city will prepare its financial statements and maintain its accounting and internal control systems in accordance with applicable standards with the goal of obtaining an unqualified opinion from its auditors.
 8. The city will prepare an Annual Comprehensive Financial Report (ACFR) and submit the ACFR to the GFOA's "Certificate of Achievement for Excellence in Financial Reporting" program.

Accounting and Financial Reporting Policies (continued)

9. Upon request, all departments will provide notice of all significant events and financial and related matters to the finance director (or designee) for the city's annual disclosures to the municipal markets as required by SEC Regulation 15-C-2-12. Full disclosure will be provided in the financial statements and bond representations. Significant events include delinquencies and defaults related to the city's bonds, adverse tax opinions or events affecting the tax-exempt status of bonds, the release, substitutions or sale of property securing repayment of bonds and other events having a significant impact on the city's finances and outstanding bonds. The finance director (or designee) will notify all Nationally Recognized Municipal Securities Information Repositories of these significant events.

10. The city's asset capitalization policy is to capitalize and depreciate assets greater than \$10,000 with a useful life beyond one year. Capital assets costing less than \$10,000 or having a useful life of one year or less will be treated as operating expenditures. Assets will be depreciated straight line over their estimated useful lives.



FUND BALANCE POLICIES

In accordance with accounting principles generally accepted in the United States of America, Council defines “governmental funds’ fund balances” as follows:

1. **Non-spendable** – Include amounts that by their nature cannot be spent such as inventories, prepaid expenditures, long-term loans and notes receivable, permanent contributions, and property held for resale.
2. **Restricted** – Includes constrained amounts that are restricted which are 1) externally imposed by creditors, grantors, contributors, or laws/regulations, or 2) internally imposed by law through constitutional provisions or *enabling legislation*. Enabling legislation authorizes the city to assess, levy, charge, or mandate payment of resources from outside the government, and includes a legally enforceable requirement that those resources be used only for specific purposes. Legally enforceable means the city can be compelled by those outside the government to use those resources for the purposes specified in the legislation.

Practical Application–External restrictions

3. **Committed** – Includes constrained amounts that can be used only for specific purposes imposed by City Council. Commitments can only be reversed by taking the same action employed to commit the amounts (e.g. ordinance). The difference between Restricted and Committed is that committed resources can be redeployed for other purposes with appropriate due process. Compliance with the commitment is not legally enforceable by those outside the government.

Practical Application – Ordinances and City Code

4. **Assigned** – Includes amounts constrained by the *intent* that they be used for specific purposes. Intent can be expressed by either the City Council or officials and committees to whom the Council has delegated authority.

Practical Application – Board Resolutions

5. **Unassigned** – Defined as the residual fund balance that is not non-spendable, restricted, committed, or assigned. Unassigned fund balance applies only to the General fund.

DEBT MANAGEMENT POLICIES

1. The finance director will structure all debt issuances and oversee the on-going management of all city debt. Debt includes general obligation bonds, lease purchase obligations, revenue bonds, special assessment obligations, promissory notes, equipment financing agreements and any other contractual arrangements that obligate the city to make future principal and interest payments.
2. No debt shall be issued for which the city has not identified specific revenue sufficient for repayment. The finance director (or designee) shall prepare an analysis of the source of repayment prior to issuance of any debt.
3. The city will not use long-term debt to fund current operations, to balance the budget or to fund projects that can be funded from current resources, unless the use of debt is otherwise determined to be in the best interest of the city.
4. The city may utilize short-term debt or inter-fund loans to cover temporary cash flow deficiencies due to timing of cash flows, such as a delay in receipting grant proceeds or other revenues and delay in issuance of long-term debt. When issuing long-term debt, the city will ensure that the debt is soundly financed by:
 - a. Incurring debt only when necessary for capital improvements too large to be financed from current available resources,
 - b. Ensuring that capital projects financed through long-term debt shall be financed for a period not to exceed the useful life of the project,
 - c. Determining that the benefits of the project financed exceed the cost of financing including interest costs, and
 - d. Analyzing the source of repayment, debt coverage ratios and the impact of debt service on annual fixed costs prior to issuance of long-term debt.
5. All bond issuances, promissory notes, and capital leases will be authorized by resolution of the City Council.
6. The city will consider establishing a credit rating when issuing debt in the capital markets and once established maintain or enhance the credit rating.

RESERVE POLICIES

1. The city will maintain sufficient contingency and reserves in each fund for the ability to:
 - a. Maintain a positive fund balance at all times.
 - b. Mitigate short-term volatility in revenues.
 - c. Mitigate short-term economic downturns (two years or less).

Reserve Policies (continued)

- d. Absorb unanticipated operating needs that arise during the fiscal year but were not anticipated during the budget process.
 - e. Sustain city services in the event of an emergency.
 - f. Meet operating cash flow requirements before the collection of property taxes, grant proceeds and other operating revenues.
 - g. Absorb unexpected claims or litigation settlements.
 - h. Meet major facility and equipment repair and replacement needs.
 - i. Meet requirements for debt reserves.
2. Reserve amounts for individual funds:
- a. **General Fund** - General Fund undesignated reserves are desired to be sufficient to meet expenditure requirements without the use of short-term borrowing. This is anticipated to be approximately twenty-five percent (25%) of General Fund operating expenditures and additional reserves as deemed appropriate by the City Manager.
 - b. **Building Fund** – Building Inspection Fund undesignated reserves are desired to be at least fifty percent (50%, approximately six months) of the operating budget to provide operational stability given the volatility of the revenue sources for this fund.
 - c. **Water Fund** – The city desires to maintain undesignated operating reserves of at least fifty percent (50%, or six months) of the operating budget for its water fund. Additionally, a major capital repair and replacement reserve and capital improvement reserve will be created and maintained in this fund.
 - d. **Wastewater and Stormwater Funds** – The city desires to maintain undesignated operating reserves of at least twenty five percent (25%, or three months) of the operating budget for its wastewater and stormwater utility funds. Additionally, a major capital repair and replacement reserve and capital improvement reserve will be created and maintained in each fund.
 - e. **All other funds** – Undesignated reserves of at least seventeen percent (17%, or two months) of the operating budget in all other operating funds unless it can be demonstrated that less than 17% is adequate to meet the needs of the fund are desired.
4. The city may use reserves on a one-time or temporary basis for purposes described above. If reserve funds are presently or anticipated to decrease to levels below the levels desired by this policy, the city will develop a plan to restore reserves to the desired levels.
5. The city shall establish a contingency reserve as part of the budget process. Funds may not be disbursed directly from contingency but must be reclassified into a spendable budget category through a supplemental budget.



RS162

Governmental Accounting

FUND ACCOUNTING

The City of Milwaukie uses fund designations to budget and report on its financial position and the results of its operations. Fund accounting demonstrates legal compliance and aids financial management by showing the different functions of municipal operations accounted for in separate, self-balancing funds. These separate funds are in accordance with state and local laws, regulations and/or special restrictions and limitations.

Funds are classified into three categories: governmental, proprietary, and fiduciary. Each category, in turn, is divided into separate fund types.

- **Governmental funds** are used to account for all or most of a government's general activities, including the collection and disbursement of earmarked monies (special revenue funds), the acquisition or construction of general fixed assets (capital project funds), and the servicing of general long-term debt (debt service funds).
 - *General* fund is used to account for general operations and activities not requiring the use of another fund type.
 - *Special revenue* funds are required to account for the use of revenue earmarked by law for a particular purpose. State and federal fuel tax revenues require special revenue funds, because federal and state laws restrict these taxes to transportation uses.
 - *Capital projects* funds are used to account for the construction or acquisition of fixed assets, such as buildings, equipment, and roads. Depending on its use, a fixed asset may instead be financed by a special revenue fund or a proprietary fund. A capital project fund exists only until completion of the project.
 - *Debt service* funds are used to account for money that will be used to pay the interest and principal of long-term debts. Bonds used by a government to finance major construction projects, to be paid by tax levies over a period of years, require a debt service fund to account for their repayment. The debts of proprietary funds are serviced within those funds, rather than by a separate debt service fund.
 - *Permanent* funds account for resources that are restricted in such a way that earnings, not principal, may be expended, and for the purpose of benefiting the government and its citizens. The city does not have any permanent funds.

Fund Accounting (continued)

- **Proprietary funds** are used to account for activities like those found in the private sector and where the determination of net income is necessary or useful to sound financial administration. Goods or services from such activities can be provided either to outside parties (enterprise funds) or to other departments or agencies primarily within the government (internal service funds). The city applies all applicable Financial Accounting Standards Board (FASB) pronouncements, issued prior to November 30, 1989, and General Accounting Standards Board (GASB) statements since that date in accounting and reporting for its proprietary operations.
 - *Internal service* funds are used for operations serving other funds or departments within a government on a cost-reimbursement basis. A printing shop which takes orders for booklets and forms from other offices and is reimbursed for the cost of each order would be a suitable application for an internal service fund.
 - *Enterprise* funds are used for services provided to the public on a user charge basis, like the operation of a commercial enterprise. Water and sewage utilities are common examples of government enterprises.

- **Fiduciary funds** are used to account for assets held on behalf of outside parties, including other governments, or on behalf of other funds within the government. When these assets are held under the terms of a formal trust agreement, a pension trust fund must be used. Agency funds are generally used to account for assets the government holds on behalf of others as their agent.

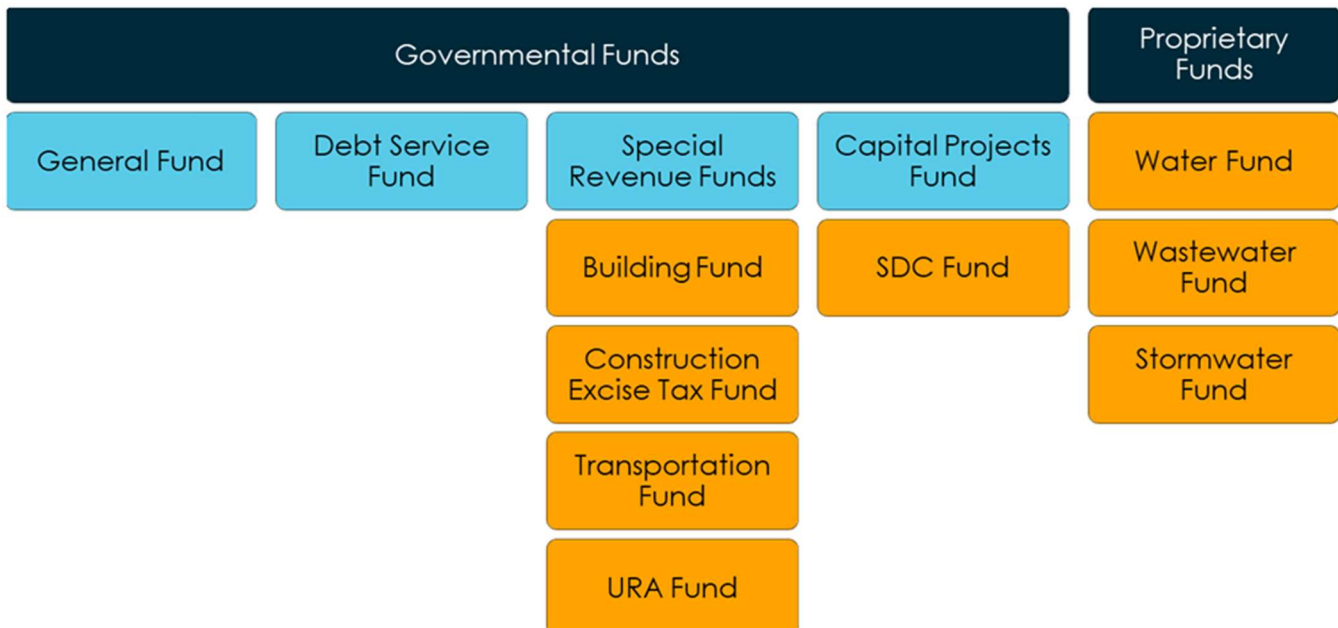

BASIS OF ACCOUNTING

The accrual basis of accounting used by most businesses requires revenue to be recognized when it is earned and expenses to be recognized when the related benefit is received. Revenues may be received during a later period, while expenses may be paid during an earlier or later period. (Cash basis accounting, used by some small businesses, recognizes revenue when received and expenses when paid.)

Governmental funds, which are not concerned about profitability, usually rely on a *modified accrual* basis. This involves recognizing revenue when it becomes both available and measurable, rather than when it is earned. *Expenditures*, a term used instead of *expenses* for modified accrual accounting, are recognized when the related liability is incurred.

Proprietary funds, used for business-like activities, operate on an accrual basis.

Government accountants sometimes refer to the accrual basis as *full accrual* to distinguish it from *modified* accrual basis accounting.

The accrual basis of accounting is applied to fiduciary funds.

FIXED ASSETS AND LONG-TERM DEBTS

State and local governments have two other groups of self-balancing accounts which are not considered funds: *general fixed assets* and *general long-term debts*. These assets and liabilities belong to the government entity, rather than a specific fund. Although general fixed assets would be part of government-wide financial statements (reporting the entity as a whole), they are not reported in governmental fund statements. Fixed assets and long-term liabilities assigned to a specific enterprise fund are referred to as *fund fixed assets* and *fund long-term liabilities*.



BUDGETARY RESERVES

Within the budget, there are targeted reserve balances to provide for times when there is fiscal duress. Adequate reserve funds are necessary to continue to provide needed services to citizens without significant interruption or uncertainty. There are two types of reserves:

- Contingency reserves represent the portion of reserve funds that may be used during the budget period for unforeseen or unexpected items, as approved.
- Unappropriated ending fund balance reserves are intended for use in future years, unless significant unforeseen issues arise that require action by management. The use of contingency reserves must be approved by the City Council through a supplemental budget process.

The primary source of revenue to fund police and library services is property taxes. Property taxes are not received until five months into the fiscal year. If adequate reserves are not maintained, the city must borrow, either internally or externally, until the receipt of funds. This increases the cost to the general fund due to required interest payments on the borrowing or loss of interest earnings when financed internally.

Bond rating agencies critically review a city's reserves prior to providing a rating on a bond sale. A better rating may result in lower interest rates on city debt, which ultimately saves taxpayers money.

FINANCIAL REPORTING

State and local governments report the results of their operations in their annual financial statements, the equivalent of a business's financial statements. They may also issue an Annual Comprehensive Financial report (ACFR), which is a more extensive document. Both annual financial statements and ACFRs include a single set of government-wide statements, for the government entity, and individual fund statements. GASB establishes standards for annual financial report preparation.

Governments do not use the terms profit and loss to describe the net results of their operations. The difference between revenues and expenditures during a year is either a surplus or a deficit. Since making a profit is not the purpose of a government, a significant surplus generally means a choice between tax cuts or spending increases. A significant deficit will result in spending cuts or borrowing. Ideally, surpluses and deficits should be small.

Financial Trends

MILWAUKIE'S ECONOMY

Milwaukie is located in northwestern Oregon, in the Portland metropolitan area north of Oregon City, in Clackamas County. Clackamas, Multnomah, and Washington Counties are among the five counties that comprise the Portland-Vancouver Primary Metropolitan Statistical Area. The city's economy is linked with that of the metropolitan area, which is based in manufacturing, national and international trade, and service industries.

POPULATION

The city's population historically grew steadily, but in recent years the population has levelled off and seen slight increases when new development has occurred. Currently, the city's population is estimated at 21,375. Below is a chart of the increase the city has seen over the past several years.

POPULATION GROWTH

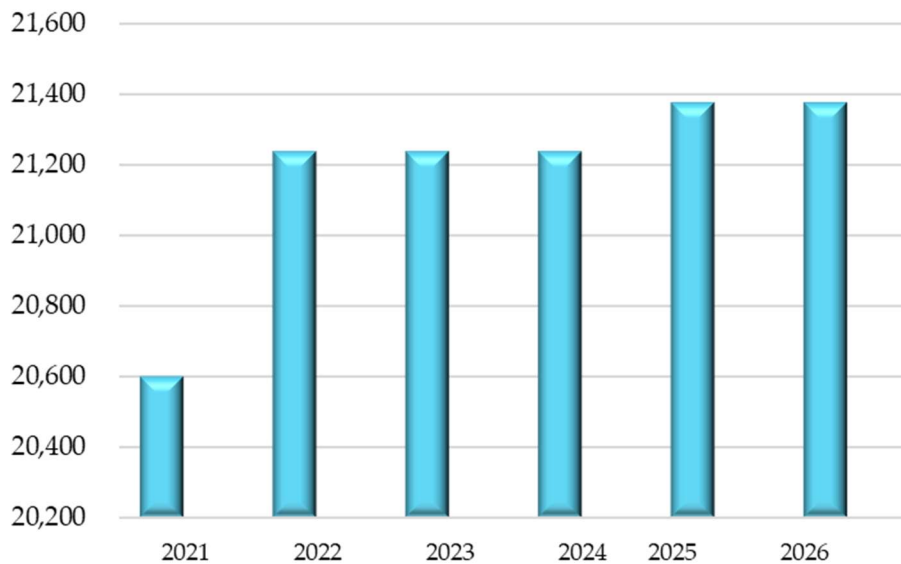

CONSUMER PRICE INDEX

The Bureau of Labor Statistics for the U.S. Department of Labor tracks the Consumer Price Index (CPI) for most U.S. cities. The CPI is a leading economic indicator that measures inflation, which is central to assessing the cost of living and whether living standards are rising or falling.

The Western Consumer Price Index (CPI-U) average for the preceding five years has been 5.6%. The city will use this increase on an annual basis, updating when the average is updated.

REVENUE TRENDS & ASSUMPTIONS

The purpose of this section is to describe the city’s major revenue sources, explain the underlying assumptions for the revenue estimates, and discuss significant revenue trends. The revenue sources and assumptions used in this budget are described in greater detail in the subsequent pages.

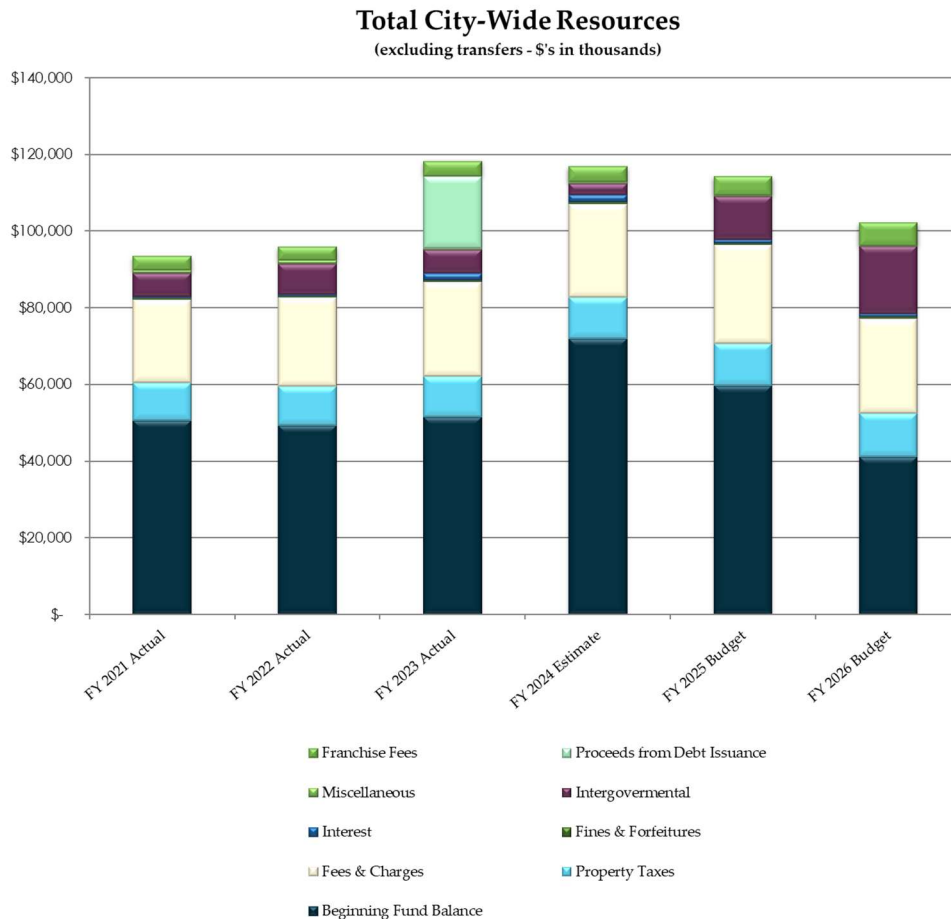

Fees & Charges (38%)

Fees & charges include licenses, permits and other items primarily in the General Fund. The charges for water, wastewater, stormwater, and street maintenance are charged to all users within the city limits for the services provided. These fees are established through the city’s fees and charges resolution; this resolution is updated every biennium unless a separate resolution was adopted mid-cycle. The City Council approves utility rates based on costs to provide services and maintain the infrastructure.

Fees & Charges by Fund (in thousands)

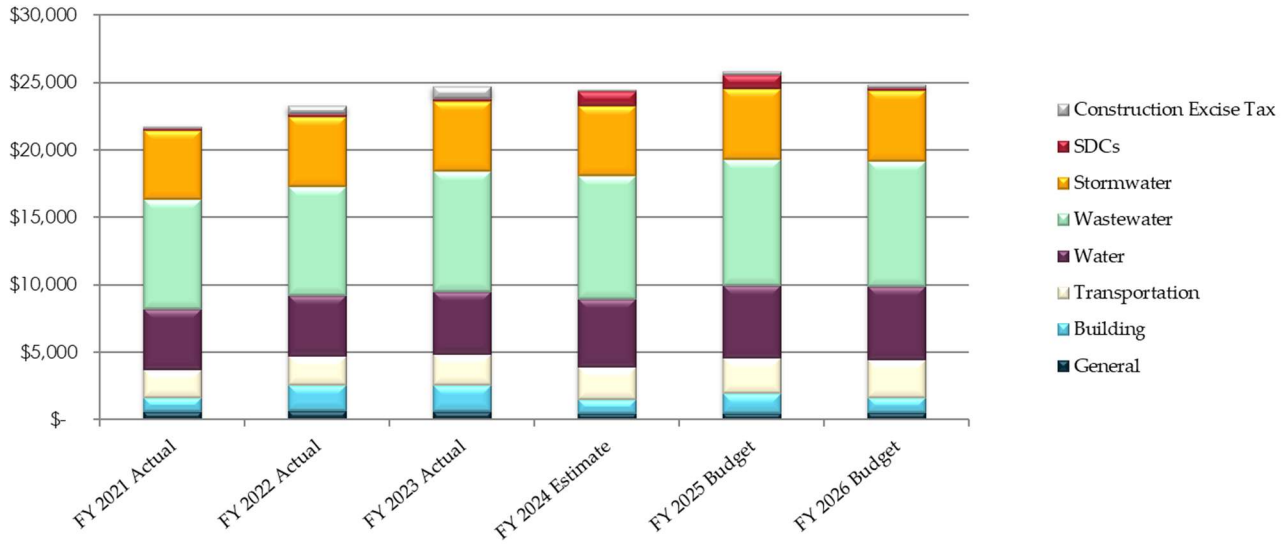

Transfers From Other Funds (8%)

Transfers from Other Funds occur when revenues are transferred between funds; revenue is received by a fund providing an internal service from a fund receiving the service, where the cost of the service is shown as an expense. All city services that receive reimbursement charge revenue are consolidated into the General Fund. The amount that other funds are charged for reimbursement costs is based on individual metrics identified for each city service. The city calculates interfund reimbursement charges when services are provided to another fund. The cost of these services is based on a cost allocation methodology, which assumes that the services provided have value, and that value is shown as a reimbursement amount.

TRANSFERS FROM OTHER FUNDS

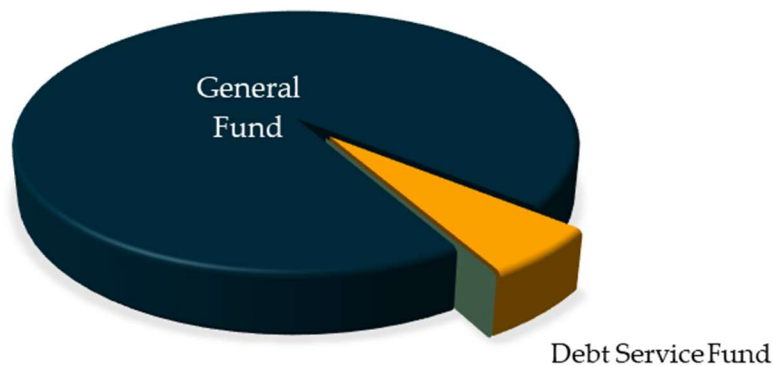

Property Taxes (20%)

Property tax revenue is influenced by cycles in the housing market, but the variances moderated with the passing of both Measures 5 and 50 of the State constitution. Thereby real market values must decline substantially before they are lower than the assessed values, however, there is not an equal or direct relationship of taxes collected to real market value due to the 3% assessed value cap as stated by Measures 5 and 50. Therefore, tax revenues are constrained to this level, even when real market values are increasing. Although property values have increased substantially over the past several years, the city's actual property tax revenues are unable to benefit from the 5% to 16% real market increases.

Milwaukie's permanent tax rate is applied to the projected taxable assessed value of property to generate revenues to support core city operations. The city realizes a 96% collection rate and any increases in revenue received above the 3% are primarily related to new construction or due to increases in the commercial and industrial sectors.

The city passed Ordinance No. 1958 in February 2006 following the annexation Ballot Measure 3-166 where the voters authorized the annexation of fire services into Clackamas Fire District #1 (CFD1). This Ordinance reduces the city's permanent tax rate of \$6.5379 per \$1,000 of assessed value by the permanent rate of the fire district, equating to \$2.4012. Accordingly, the actual property tax rate levied by the city is its permanent tax rate of \$6.5379 less CCFD1's permanent rate of \$2.4012 (\$4.1367).

Intergovernmental (25%)

Intergovernmental revenues include state revenues which are distributed to cities based on state statute, which defines formulas incorporating population and per capita income. The League of Oregon Cities provides the source data for State Revenue Sharing projections. Pursuant to ORS 221.770, the City of Milwaukie must elect to receive its proportionate share of the revenues to be apportioned to the cities by the State of Oregon for the fiscal year. Further, ORS 221.760 provides that cities located in a county having more than 100,000 inhabitants according to the most recent federal decennial census, can disburse state shared revenue funds only if the city provides four or more of the following services: police protection; fire protection; street construction, maintenance, and lighting; sanitary sewer; storm sewers; planning, zoning, and subdivision control; one or more utility services. Operating and capital improvement grants are also included in intergovernmental revenues. Often these grants are only received after the city has incurred the related expenditure.

Intergovernmental Revenues by Type (in thousands)

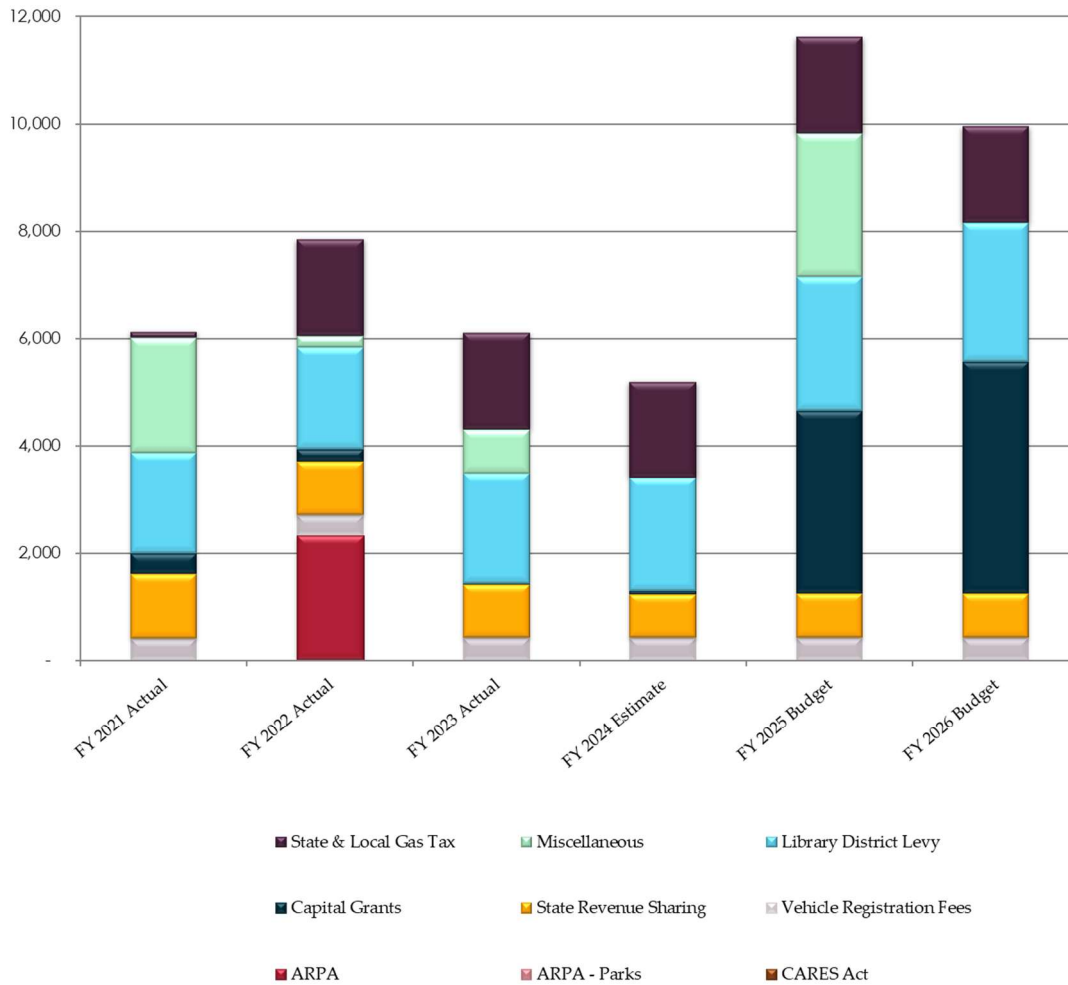

Other (9%)

Other revenues consist of proceeds from franchise fees (8%), fines and forfeitures (1%).

EXPENDITURE TRENDS & ASSUMPTIONS

The purpose of this section is to describe the city’s major expenses, explain the underlying assumptions for the expense estimates, and discuss significant trends. The City of Milwaukie’s budget includes five requirement categories: Personnel Services, Materials & Services, Debt Service, Transfers, and Capital Outlay.

Major Requirements

Major requirements relate to the people who provide city services and the materials they need to complete their job requirements. Citywide budgeted requirements are based on current budgeted staffing levels and expected increases in salaries and benefits.

Total City-Wide Expenditures
(excluding transfers - \$'s in thousands)

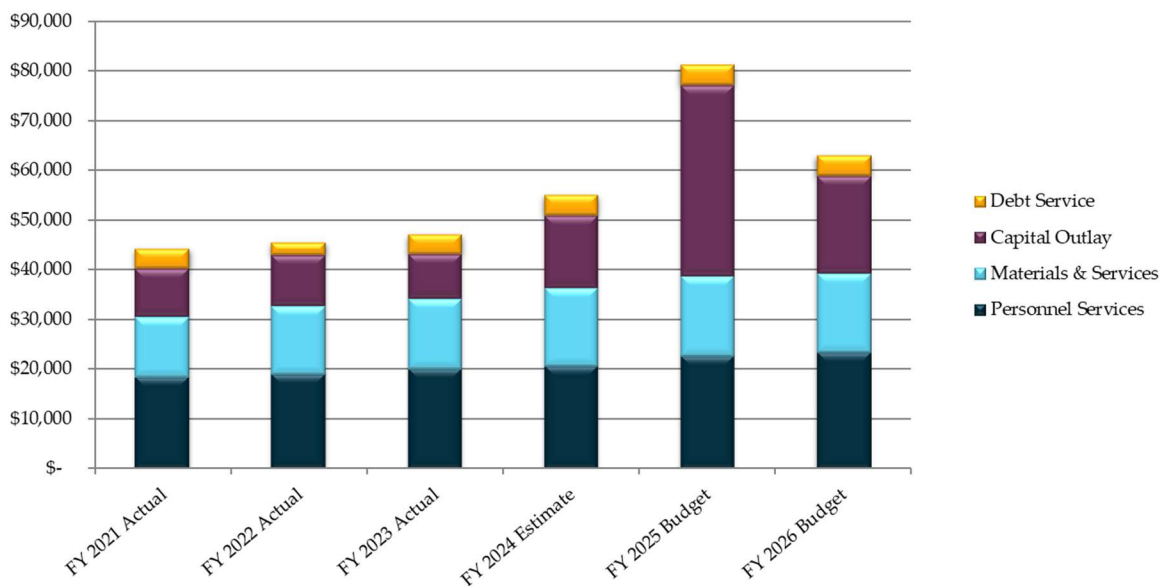

Personnel Services (32%)

Citywide, Personnel Services budgeted requirement increases in the 2025-2026 biennium are in part attributable to the increased benefit costs. Health insurance is projected to increase at least 7% in FY 2025 and FY 2026. Oregon state and local governments pay for pension costs into the Oregon Public Retirement System (PERS). PERS liability throughout the state continues to climb significantly. In 2019, Senate Bill 1049 was passed to make changes to help offset some of the rising costs that state and local governments are facing. As such, these rates increase to make up for losses; in FY 2025 and FY 2026, there will most likely be a rate increase, but at the time of this proposed budget, PERS has not released the data. Currently, the rate for general service employees is 17.4% and police is 22.19%.

Materials & Services (22%)

Citywide, Materials & Services budgeted requirement increases over the prior fiscal year are, in many situations, based on known expenditure increases. Where such increases are unknown, 2025-2026 biennium amounts are identified using an inflationary cost increase from the prior biennium.

Materials & Services by Fund
(in thousands)

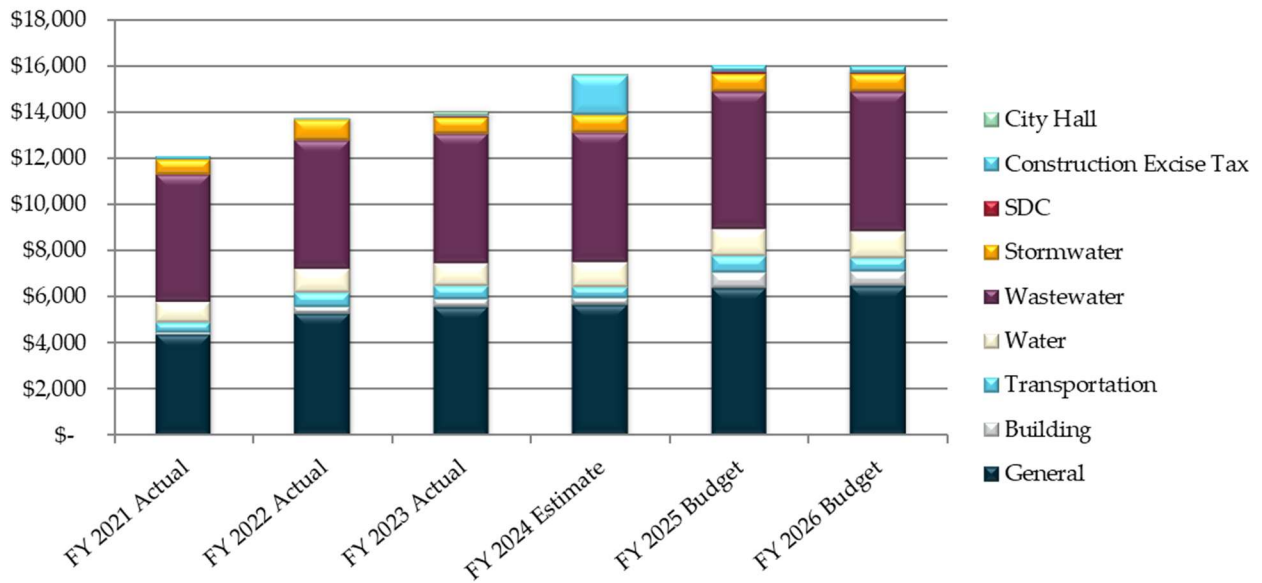

Transfers to Other Funds (10%)

Budgeted transfers represent transfers to account for the support service costs of the General Fund departments. The Debt Service Fund receives a transfer from the General Fund for new City Hall debt services.

TRANSFERS TO OTHER FUNDS

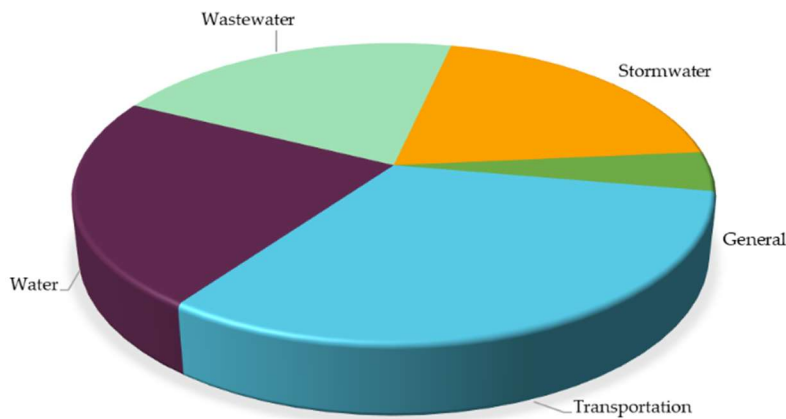

Capital Outlay (30%)

The Capital Outlay budget is projected below to be very large in the first three years of the CIP due to the integrated transportation projects for the utility funds based on the escalation of the SAFE program approved by City Council.

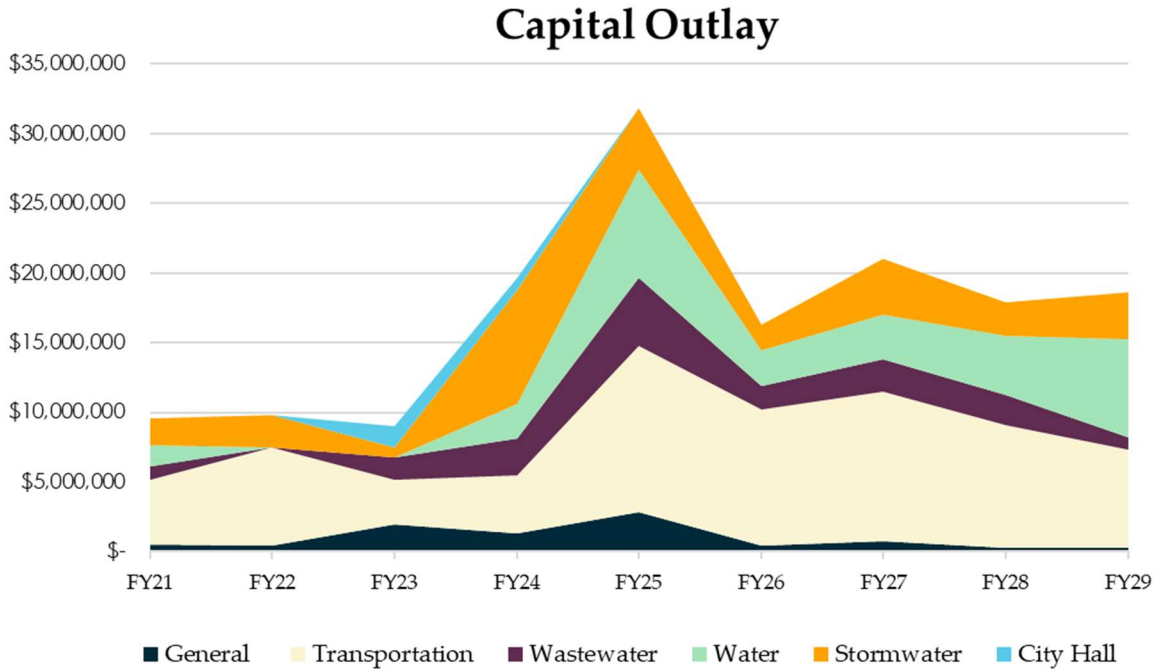

Debt Service (6%)

Debt service payments are current payments towards the city’s outstanding long-term debt of \$36.9 million and the city pays annually approximately \$2.7 million. The city’s largest debt is related to the improvements in the transportation infrastructure which is outlined further in the department budgets and the CIP. The city anticipates the second issuance of a transportation bond to occur in this next biennium for \$21 million. No further debt is anticipated for the city except for the Milwaukie Redevelopment Commission Urban Renewal Fund, which is a separate entity of the city.

Outstanding Debt

SUMMARY OF OUTSTANDING DEBT

Below is a table showing the outstanding balances by type, interest rates, and annual debt service for fiscal years 2025 and 2026. This table is for current debt issued and does not include anticipated future debt.

Purpose	Loan Type	Due	Interest Rate	Outstanding Amount	Annual Debt Service	
					FY 2025	FY 2026
Transportation Capital Projects	Full Faith and Credit Obligations (2018)	2048	3-5%	\$ 17,225,000	\$ 641,000	\$ 641,000
Transportation & MRC Capital Projects	Full Faith and Credit Obligations (2023)	2042	3.96%	22,180,100	1,684,000	1,684,000
Library Capital Project	General Obligation Bonds (2016)	2036	2-4%	6,500,000	590,000	585,000
City Hall Purchase	Full Faith and Credit Obligations (2020)	2040	2-4%	5,845,000	432,000	433,000
Light-Rail Enhancements	General Obligation Bonds (2014)	2034	3-4%	2,375,000	262,000	264,000
PERS Unfunded Actuarial Liability	Liability Bonds (2005)	2028	4-5.5%	2,005,000	502,000	526,000
Department of Environmental Quality	Oregon Special Public Works Fund (2010)	2031	0%	771,662	99,000	99,000
Milwaukie Bay Park Enhancements	Full Faith and Credit Obligations (2014)	2029	3-4%	445,000	84,000	86,000
North Main Village Public Area Improvements	Oregon Public Works Loan (2006)	2031	4-5.5%	322,408	45,000	44,000
				\$ 57,669,170	\$ 4,339,000	\$ 4,362,000

How do we compare?

The graph includes a comparison of debt based on audited financial reports of surrounding cities in the Portland Metro Area.

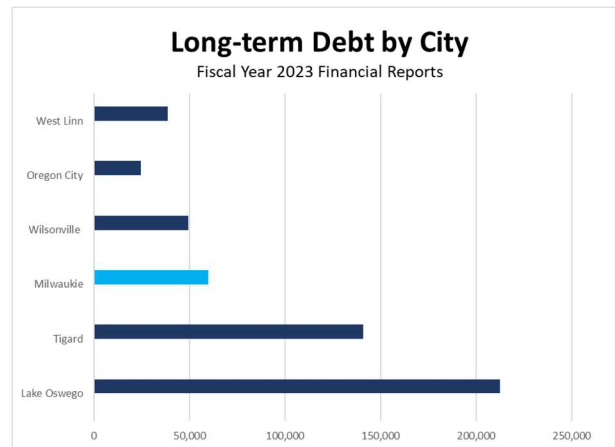

LEGAL DEBT LIMITS

Cities in Oregon have a legal debt limit on General Obligation debt equal to 3% of their True Market Value. For the City of Milwaukie, the legal debt margin available for future indebtedness is \$108 million.



RS176

Personnel Overview

SUMMARY OVERVIEW OF PERSONNEL CHANGES

Every budget cycle, the city evaluates the needs related to the city and how personnel costs affect each department while maintaining high service levels. During the biennium, positions may change, transfer, or adjust as needed by city management. This occurred across most departments last year but was neutral in terms of overall city staffing levels. In this budget, the city has determined that no additional FTE will be needed for this upcoming biennium.

Some changes to Staffing:

- 2.5 FTE for Administrative Specialist II positions were consolidated to the Department of the City Recorder. 1.5 FTE came from Community Development, 0.5 FTE came from Engineering, and the final 0.5 FTE came from the City Manager’s Department.
- The Behavioral Health Specialist position was moved from the City Manager’s Department to the Police Department.
- Water Fund added a Lead Water Treatment Operator position along with one additional Water Treatment Operator position.





RS178

POSITIONS BY DEPARTMENT

Department and Position	FTE Counts				
	Budget Year FY 2023	Budget Year FY 2024	Increase (Decrease)	Budget Year FY 2025	Budget Year FY 2026
GENERAL FUND					
CITY MANAGER					
City Manager	1.00	1.00	-	1.00	1.00
Assistant City Manager	1.00	1.00	-	1.00	1.00
Behavioral Health Specialist	1.00	1.00	(1.00) <i>Moved to Police</i>	-	-
Community Engagement Coordinator	1.00	1.00	-	1.00	1.00
Equity & Inclusion Coordinator	1.00	1.00	-	1.00	1.00
Communication Program Manager	1.00	1.00	-	1.00	1.00
Event & Emergency Management Coordinator	1.00	1.00	-	1.00	1.00
Web Services Coordinator	0.50	0.50	-	0.50	0.50
Administrative Specialist II	0.50	0.50	(0.50) <i>Moved to OCR</i>	-	-
	8.00	8.00	(1.50)	6.50	6.50
CITY ATTORNEY					
City Attorney	1.00	1.00	-	1.00	1.00
	1.00	1.00	-	1.00	1.00
COMMUNITY DEVELOPMENT					
Community Development Director	1.00	1.00	-	1.00	1.00
Development Project Manager	1.00	1.00	-	1.00	1.00
Parking Management Coordinator - <i>Limited Term</i>	1.00	1.00	(1.00)	-	-
Housing & Economic Development Coordinator	1.00	1.00	(1.00)	-	-
Administrative Specialist II	1.50	1.50	(1.50) <i>Moved to OCR</i>	-	-
	5.50	5.50	(3.50)	2.00	2.00
PUBLIC WORKS ADMINISTRATION					
Public Works Director	1.00	1.00	-	1.00	1.00
Climate & Natural Resources Manager	1.00	1.00	-	1.00	1.00
GIS Coordinator	1.00	1.00	-	1.00	1.00
Development Project Manager	1.00	1.00	-	1.00	-
Environmental Services Coordinator	1.00	1.00	-	1.00	1.00
Asset Management Coordinator	1.00	1.00	-	1.00	1.00
Administrative Specialist III	1.00	1.00	-	1.00	1.00
Administrative Specialist II	1.00	1.00	-	1.00	1.00
	8.00	8.00	-	8.00	7.00
ENGINEERING SERVICES					
City Engineer	1.00	1.00	-	1.00	1.00
Assistant City Engineer	1.00	1.00	-	1.00	1.00
Civil Engineer	3.00	3.00	-	3.00	3.00
Associate Engineer	1.00	1.00	-	1.00	1.00
Engineering Technician III	1.00	1.00	-	1.00	1.00
Engineering Technician II	2.00	2.00	1.00	3.00	3.00
Engineering Technician I	1.00	1.00	(1.00)	-	-
Administrative Specialist II	0.50	0.50	(0.50) <i>Moved to</i>	-	-
	10.50	10.50	(0.50)	10.00	10.00
FACILITIES MANAGEMENT					
Fleet & Facilities Supervisor	1.00	1.00	-	1.00	1.00
Facilities Maintenance Technician	2.00	2.00	-	2.00	2.00
	3.00	3.00	-	3.00	3.00
FINANCE					
Finance Director	1.00	1.00	-	1.00	1.00
Assistant Finance Director	1.00	1.00	-	1.00	1.00
Accountant	1.00	1.00	-	1.00	1.00
Accounting and Contract Specialist	1.00	1.00	-	1.00	1.00
Payroll Specialist	1.00	1.00	-	1.00	1.00
Accounting Technician	2.00	2.00	-	2.00	2.00
	7.00	7.00	-	7.00	7.00

Department and Position	FTE Counts				
	Budget year FY 2023	Budget year FY 2024	Increase (Decrease)	Budget year FY 2025	Budget year FY 2026
GENERAL FUND, CONTINUED					
FLEET SERVICES					
Lead Mechanic	1.00	1.00	-	1.00	1.00
Mechanic	2.00	2.00	-	2.00	2.00
	3.00	3.00	-	3.00	3.00
HUMAN RESOURCES					
Human Resources Director	1.00	1.00	-	1.00	1.00
Human Resources Analyst	1.00	1.00	-	1.00	1.00
	2.00	2.00	-	2.00	2.00
INFORMATION TECHNOLOGY					
IT Manager	1.00	1.00	-	1.00	1.00
IT Analyst II	1.00	1.00	-	1.00	1.00
IT Analyst I	1.00	1.00	-	1.00	1.00
	3.00	3.00	-	3.00	3.00
MUNICIPAL COURT					
Court Clerk	0.50	0.50	0.50	1.00	1.00
	0.50	0.50	0.50	1.00	1.00
PLANNING SERVICES					
Planning Manager	1.00	1.00	-	1.00	1.00
Senior Planner	2.00	2.00	-	2.00	2.00
Associate Planner	1.00	1.00	1.00	2.00	2.00
Assistant Planner	1.00	1.00	(1.00)	-	-
	5.00	5.00	-	5.00	5.00
CODE ENFORCEMENT					
Code Compliance Coordinator	1.00	1.00	-	1.00	1.00
Code Compliance Specialist	1.00	1.00	-	1.00	1.00
Parking Enforcement Officer	1.00	1.00	-	1.00	1.00
	3.00	3.00	-	3.00	3.00
CITY RECORDER					
City Recorder	1.00	1.00	-	1.00	1.00
Deputy City Recorder	1.00	1.00	-	1.00	1.00
Administrative Specialist II	1.00	1.00	2.50	3.50	3.50
Court Clerk	0.50	0.50	(0.50)	-	-
	3.50	3.50	2.00	5.50	5.50
LIBRARY					
Library Director	1.00	1.00	-	1.00	1.00
Library Manager	2.00	2.00	-	2.00	2.00
Librarian	4.48	4.48	0.02	4.50	4.50
Library Assistant II	2.90	2.90	-	2.90	2.90
Library Assistant I	5.75	5.75	1.05	6.80	6.80
Librarian, On-Call (<i>part-time</i>)	0.82	0.82	(0.22)	0.60	0.60
Library Assistant I, On-Call (<i>part-time</i>)	1.30	1.30	(0.85)	0.45	0.45
	18.25	18.25	-	18.25	18.25
POLICE					
Police Chief	1.00	1.00	-	1.00	1.00
Police Captain	2.00	2.00	-	2.00	2.00
Police Sergeant	7.00	7.00	-	7.00	7.00
Police Records Supervisor	1.00	1.00	-	1.00	1.00
Behavioral Health Specialist	-	-	1.00	1.00	1.00
Police Officer	22.00	22.00	-	22.00	22.00
Police Officer - <i>School Resource Officer</i>	1.00	1.00	-	1.00	1.00
Police Officer - <i>Transit</i>	-	-	1.00	1.00	1.00
Property Room Technician	1.00	1.00	-	1.00	1.00
Records Specialist	2.00	2.00	-	2.00	2.00
Administrative Specialist II	1.00	1.00	-	1.00	1.00
<i>Part-time employee(s)</i>	0.50	0.50	-	0.50	0.50
	38.50	38.50	2.00	40.50	40.50

Department and Position	FTE Counts				
	Budget year FY 2023	Budget year FY 2024	Increase (Decrease)	Budget year FY 2025	Budget year FY 2026
BUILDING FUND					
Building Official	1.00	1.00	-	1.00	1.00
Building Inspector / Plan Examiner	1.00	1.00	-	1.00	1.00
Permit Technician	1.00	1.00	-	1.00	1.00
Permit Coordinator	-	-	1.00	1.00	1.00
	3.00	3.00	1.00	4.00	4.00
TRANSPORTATION FUND					
Streets/Water Supervisor	0.50	0.50	-	0.50	0.50
Lead Utility Technician	1.00	1.00	-	1.00	1.00
Sign Maintenance Technician	1.00	1.00	-	1.00	1.00
Utility Technician II	3.00	3.00	-	3.00	3.00
<i>Part-time seasonal employee(s)</i>	0.50	0.50	-	0.50	0.50
	6.00	6.00	-	6.00	6.00
WATER FUND					
Streets/Water Supervisor	0.50	0.50	-	0.50	0.50
Water Treatment Operator	1.00	1.00	1.00	2.00	2.00
Cross Connections Specialist	1.00	1.00	-	1.00	1.00
Lead Utility Technician	1.00	1.00	-	1.00	1.00
Lead Water Treatment Operator	-	-	1.00	1.00	1.00
Utility Technician II	4.00	4.00	(1.00)	3.00	3.00
<i>Part-time seasonal employee(s)</i>	0.50	0.50	-	0.50	0.50
	8.00	8.00	1.00	9.00	9.00
WASTEWATER FUND					
Sewer/Storm Supervisor	0.50	0.50	-	0.50	0.50
Lead Utility Technician	1.00	1.00	-	1.00	1.00
Utility Technician II	2.00	2.00	1.00	3.00	3.00
Utility Technician I	1.00	1.00	(1.00)	-	-
	4.50	4.50	-	4.50	4.50
STORMWATER FUND					
Sewer/Storm Supervisor	0.50	0.50	-	0.50	0.50
Urban Forester	1.00	1.00	-	1.00	1.00
Lead Utility Technician	1.00	1.00	-	1.00	1.00
Utility Technician II	4.00	4.00	-	4.00	4.00
Natural Resources Technician I	1.00	1.00	-	1.00	1.00
<i>Part-time seasonal employee(s)</i>	0.50	0.50	-	0.50	0.50
	8.00	8.00	-	8.00	8.00
TOTAL CITY-WIDE					
Total Full-Time Positions	145.13	145.13	2.07	147.20	146.20
Total Part-Time/On-Call Positions	4.12	4.12	(1.07)	3.05	3.05
Total Full-Time Equivalents (FTEs)	149.25	149.25	1.00	150.25	149.25
TOTAL BY FUND					
General Fund	119.75	119.75	(1.00)	118.75	117.75
All other Funds	29.50	29.50	2.00	31.50	31.50
Total Full-Time Equivalents (FTEs)	149.25	149.25	1.00	150.25	149.25



RS182

Transfers

OVERVIEW

Transfers are used to account for direct and indirect costs that the general fund covers for other internal city services. The intent of transfers is to recoup general fund costs for time and effort spent on special revenue or proprietary funds for services provided by general fund departments.

METHODOLOGY

The City of Milwaukie adopted an Activity-Based Costing (ABC) methodology to support transfers. This methodology has also been recognized by the Government Finance Officers Association (GFOA) as a best practice approach to capture the direct and indirect costs of the internal service provided by the general fund. The ABC model identifies overhead and/or indirect activities (i.e., the departments within the general fund) in an organization and assigns the cost of each activity to other departments according to the purposes of allocation. For example, using the ABC methodology, a human resources department expense is charged to departments based on their portion of the total full-time employee (FTE) count.

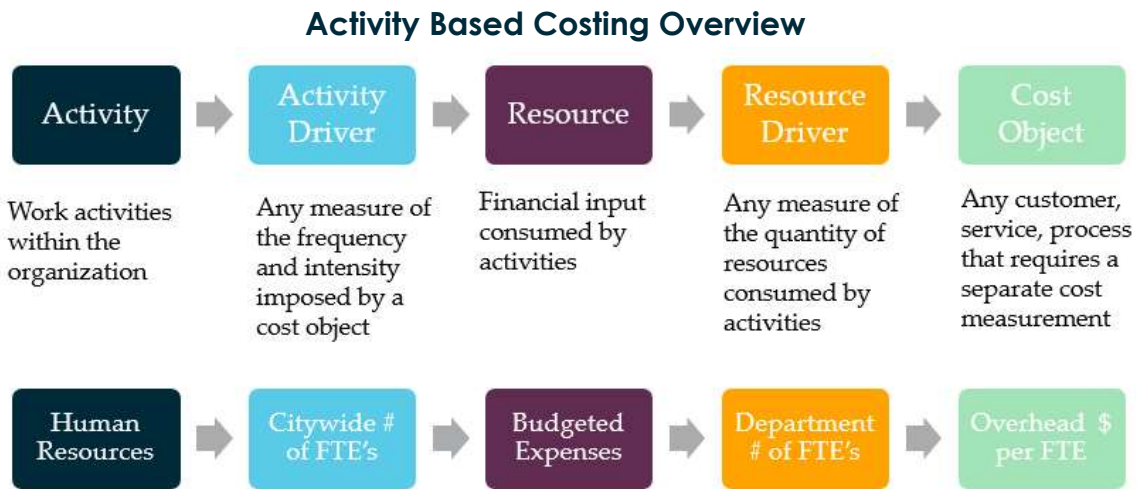

Transfers are the authorized exchange of cash or other resources between funds that are appropriated along with the other expenditures within the adopted budget. Transfers are necessary in a fund accounting system to balance each fund on its own. It is a system used to allocate indirect costs that other funds (i.e., general fund) pay for on behalf of a particular fund's operations. The following transfer summary allocates the city's indirect overhead costs in the applicable departments incurred within the general fund to the other applicable funds that are outside of the general fund. The purpose of this is to: (1) to balance all funds on their own, and (2) reflect the full cost of services by incorporating direct and indirect costs of the function into the adopted budget for each fund.

ALLOCATED COSTS

Operating budgets in the general fund consist of personnel costs, building maintenance, fleet maintenance (including gas), bank and merchant card charges, legal costs, and other costs. Allocated costs also include certain capital expenses and debt service for the new city hall. The debt for the new city hall is spread across the departments that will use the new city hall, each having a part of the debt payment based on the number of FTEs in the department. The resources restricted to the payment of other long-term debt included in the debt service fund are not available or allocable to other funds and are therefore exempt from interfund transfers. The city hall and system development charge (SDC) funds are not allocated due to the nature of those funds capturing capital expenditure costs only.

ACTIVITY COST DRIVER: Full-Time Equivalent (FTE) by Function - Engineering

Citywide employee details are within the department budgets, however there is one variable related to FTE counts between the department budgets and the transfers. That variable is with the engineering department as those employees provide the design and implementation of capital projects associated with the transportation and utility funds. As such, the portion of time on each fund is split by the total FTE within engineering. The table below illustrates this breakdown and is used in the allocations as a cost driver for several departments.

Engineering Department	FTE	General	SSMP	SAFE	Street	Water	Wastewater	Storm	Total
City Engineer	1.0	0.3	0.1	0.2	0.1	0.1	0.1	0.1	1.00
Assistant City Engineer	1.0	0.1	0.2	0.2	0.1	0.1	0.1	0.3	1.00
Civil Engineer	3.0	0.0	0.5	0.5	0.5	0.5	0.5	0.5	3.00
Engineering Technician III	1.0	0.1	0.2	0.2	0.1	0.2	0.2	0.2	1.00
Associate Engineer	1.0	0.3	0.2	0.1	0.1	0.1	0.1	0.1	1.00
Engineering Technician II	3.0	0.0	0.5	0.5	0.5	0.5	0.5	0.5	3.00
	10	0.8	1.6	1.7	1.4	1.5	1.5	1.7	10.0
		8%	16%	17%	14%	15%	15%	17%	100%

ACTIVITY COST DRIVER: Functions Served

Functions served represent the activities and the costs based on various assumptions and are not always the same in each case. Although there isn't a one-size fits all to calculating the functions served, the general items included are the assumed operating costs as outlined in the department budgets and the assumed operating revenue or net income. Functions served for several departments is outlined below.

Community Development - Administration

The costs for community development regarding administration is based on two primary components (a) the net operating income of each fund that the community development is primarily involved with given the allocation of employees, the functions, the projects, etc.; and

(b) the assumption that the department is split based on the allocation of the time involved in each of the other funds.

(Dollar amounts in thousands: \$100 = \$100,000)

	FY 25	FY 26	BN Total
Personnel Services	\$ 410	\$ 422	\$ 832
Materials & Services	251	191	442
Allocated Operating Costs	\$ 661	\$ 613	\$ 1,274

Fund	Biennium Net Operating Income	Operating Income % Allocation	% Allocation of total function	FY 25	FY 26	BN Total
Building	\$ 202	1%	4%	\$ 27	\$ 25	\$ 52
Construction Excise Tax	1,948	6%	2%	13	12	25
SAFE	3,106	9%	3%	21	18	39
State Gas	4,044	11%	3%	21	18	39
Water	10,048	28%	5%	34	31	65
Wastewater	6,398	18%	5%	34	31	65
Stormwater	7,839	22%	5%	34	31	65
MRC-URA	1,763	5%	4%	27	25	52
	\$ 35,347	100%	31%	\$ 212	\$ 190	\$ 402

<i>General Fund Costs</i>	\$ 449	\$ 423	\$ 872
	68%	69%	68%

Public Works Administration

The public works department's administrative costs include expenses related to administering the city's utility funds and programs for sustainability and parks. The department's administration portion is split equally amongst the utility funds but the costs for sustainability and parks is split between the general fund (60%) and other funds (40%). This general fund split is used to review the operating costs for the sustainability and parks programs. Once the costs are identified, those costs are recalibrated between the split and based on the weighted average of the net operating income by utility fund.

Public Works Administration, continued

(Dollar amounts in thousands: \$100 = \$100,000)

			FY 2025	FY 2026	BN Total
Personnel Services	\$		1,157	\$ 1,117	\$ 2,274
Materials & Services			173	172	345
Less Sustainability & Parks (see below)			(250)	(200)	(450)
Allocated Operating Costs	\$		1,080	\$ 1,089	\$ 2,169

Biennium Net Operating					
Fund	Income	% Allocation	FY 2025	FY 2026	BN Total
SSMP	\$ 3,652	10%	\$ 112	\$ 113	\$ 226
SAFE	3,106	9%	96	96	192
State Gas	4,044	12%	124	126	250
Water	10,048	29%	309	312	621
Wastewater	6,398	18%	197	199	396
Stormwater	7,839	22%	241	243	485
\$	35,086	100%	\$ 1,080	\$ 1,089	\$ 2,169

General Fund Costs @ 0%	\$	-	\$	-	\$	-
		0%		0%		0%

Public Works Administration – Sustainability & Parks

(Dollar amounts in thousands: \$100 = \$100,000)

			FY 2025	FY 2026	BN Total
Staff Positions	\$		220	\$ 170	\$ 390
Costs (see department budget)			30	30	60
Total Operating Costs	\$		250	\$ 200	\$ 450

Biennium Net Operating						
Fund	Income	% Allocation	40%	FY 2025	FY 2026	BN Total
SSMP	\$ 3,652	10%	4%	\$ 10	\$ 8	19
SAFE	3,106	9%	4%	9	7	16
State Gas	4,044	12%	5%	12	9	21
Water	10,048	29%	11%	29	23	52
Wastewater	6,398	18%	7%	18	15	33
Stormwater	7,839	22%	9%	22	18	40
\$	35,086	100%	40%	\$ 100	\$ 80	180

General Fund Costs	\$	150	\$	120	\$	270
		60%		60%		60%

Planning

The planning department has components that provide services to the utility funds. Based on prior historical trends and similarly to the public works department, the costs associated with the planning department are allocated to 60% general fund and 40% with the other funds.

(Dollar amounts in thousands: \$100 = \$100,000)

				FY 25	FY 26	BN Total		
	Personnel Services	\$		792	\$	815	\$	1,607
	Materials & Services			77		153		230
	Total Operating Costs	\$		869	\$	968	\$	1,837

Fund	Biennium Net Operating			40%	FY 25	FY 26	BN Total
	Income	% Allocation					
Building	\$ 202	1%	1%	\$ 6	\$ 8	\$ 14	
SSMP	3,652	10%	4%	32	35	67	
SAFE	3,106	9%	4%	31	34	65	
State Gas	4,044	11%	5%	40	44	84	
Water	10,048	28%	11%	99	110	209	
Wastewater	6,398	18%	7%	63	70	133	
Stormwater	7,839	22%	9%	77	86	163	
	\$ 35,289	100%	40%	\$ 348	\$ 388	\$ 735	

<i>General Fund Costs</i>	\$ 521	\$ 580	\$ 1,102
	60%	60%	60%



ACTIVITY COST DRIVER: Facilities Management

Cost allocation for the facilities department is based on the total square footage of space needed to maintain the city’s work sites including cleanings, utilities, general maintenance, repairs, and space configurations. In this biennium, the facilities budget includes costs for maintaining (not capital improvements) of the new city hall. Maintenance costs for the Johnson Creek Building/Public Works (JCB/PW) campus are also maintained in this department and as such, the costs are allocated back to the funds. Lastly, remodel costs budgeted in this biennium in the facilities budget are allocated to the utility funds that own the JCB/PW campus.

(Dollar amounts in thousands: \$100 = \$100,000)

					Expenses:		
					FY 25	FY 26	BN Total
JCB Projects					\$ 184	\$ 80	\$ 264
Budgeted Expenses-Facilities					\$ 1,338	\$ 1,480	\$ 2,818

Fund	Sq. Ft JCB/PW (000's)	JCB/PW % of Use*	Sq. Ft City Hall (000's)	City Hall % of Use*	JCB Projects	FY 25	FY 26	BN Total
Building	-	0%	52	20%	\$ -	\$ 10	\$ 10	\$ 20
State Gas	292	25%	52	8%	66	37	37	74
Water	292	25%	52	3%	66	34	34	69
Wastewater	292	25%	52	3%	66	34	34	69
Stormwater	292	25%	52	3%	66	34	34	69
					\$ 264	\$ 150	\$ 150	\$ 300
General Fund Costs (City Hall, Library & Police Buildings)					\$ 1,188	\$ 1,330	\$ 2,518	
						89%	90%	89%

*Use includes office spaces, workstations, breakrooms, parking, lavatories, conference rooms, council chambers, front office counter space, storage, and other miscellaneous areas.

ACTIVITY COST DRIVER: Bank & Merchant Service Fees

Bank and merchant service fees are budgeted based on services the city provides by the bank and merchant carriers. These fees are then allocated in a three-step process:

- 1) First, bank fees include what the city pays for with ongoing costs to maintain the services needed such as banking administration, positive pay, purchasing cards, and other services. Merchant Service fees are a direct cost from card providers such as Visa, MasterCard, and American Express. These fees can fluctuate with the amount of revenue received in each fund. The biennial total amount of these fees are the anticipated budgeted expenses.
- 2) Costs based on the total cash balances as reported in the Fiscal Year 2023 audited Annual Comprehensive Financial Report (ACFR) are allocated.
- 3) Lastly, the merchant services fees which are a direct outflow of operating revenue received by the funds, are allocated by department with the anticipated budgeted expenses as shown below.

(Dollar amounts in thousands: \$100 = \$100,000)

	FY 25	FY 26
Budgeted Expenses	\$ 210	\$ 210

Fund	2023		BN		FY 25	FY 26	BN Total
	Audited Cash	% Allocation	Budgeted Operating Revenue	% Allocation			
General	\$ 14,555	17%	\$ (301)	-1%	\$ 3	\$ 3	\$ 6
Other (CET, MRC)	9,615	11%			0%	3	3
<i>Remains in General Fund Allocation</i>					6	6	12
Building	4,666	5%	2,568	5%	10	11	21
SSMP + SDC	10,327	12%	3,297	7%	15	15	30
SAFE + SDC	10,689	12%	2,930	6%	14	14	28
State Gas + SDC	7,647	9%	2,612	5%	12	12	24
Water + SDC	10,791	13%	10,556	21%	41	43	83
Wastewater + SDC	8,289	10%	18,490	37%	68	72	140
Stormwater + SDC	9,393	11%	10,473	21%	40	42	82
	\$ 85,973	100%	\$ 50,625	100%	\$ 205	\$ 215	\$ 420

ACTIVITY COST DRIVER: Utility Billing

Utility billing functions are housed within the finance department budget and include direct costs of collecting fees for transportation and utility funds. The income that supports the city's utility billing operations is based on revenue from the services performed by the department and does not include revenues from intergovernmental income or debt. The position's base funding is determined by using personnel costs of each employee involved in the utility billing process and any contracted costs such as meter readers and printers. The combination of these costs is then split as a percentage of the total operating revenues. Costs for bank charges and merchant services fees (credit cards) are allocated separately.

(Dollar amounts in thousands: \$100 = \$100,000)

	FY 25	FY 26	BN Total
Personnel Services	\$ 217	\$ 228	\$ 445
Materials & Services	125	125	250
<i>Allocated Operating Costs</i>	\$ 342	\$ 353	\$ 695

Utility	Biennium		FY 25	FY 26	BN Total
	Net Operating Income	% Allocation			
SSMP	\$ 3,698	7%	\$ 24	\$ 25	\$ 49
SAFE	8,630	16%	56	58	114
Water	11,061	21%	72	74	146
Wastewater	18,779	36%	122	126	247
Stormwater	10,627	20%	69	71	140
	\$ 52,795	100%	\$ 342	\$ 353	\$ 695
<i>General Fund Costs</i>			\$ -	\$ -	\$ -
			0%	0%	0%

ACTIVITY COST DRIVER: Fleet Services

The allocation of fleet services is based on the total number of vehicles and equipment the department services. Equipment is allocated at 50% of the total amount of equipment as the services are limited. The utility funds also use shared services which are accounted for in the schedule below.

(Dollar amounts in thousands: \$100 = \$100,000)

						FY 25	FY 26		
Budgeted Expenses						\$ 679	\$ 696		

Fund	# of Current & Added Vehicles	50% total of Equipment	Shared Vehicles & Equipment	Total	% Allocation	FY 25	FY 26	BN Total
General	64	22	-	86	38%	\$ 261	\$ 267	\$ 528
Building	1	-	-	1	0%	3	3	6
State Gas	7	18	9	34	15%	103	106	209
Water	7	19	9	35	16%	106	109	215
Wastewater	5	12	9	26	12%	79	81	160
Stormwater	5	28	9	42	19%	127	131	258
	89	99	36	224	100%	\$ 679	\$ 696	\$ 1,375

ACTIVITY COST DRIVER: Information Technology

The information technology (IT) department's allocation is based on the number of devices it supervises across the city, including laptops, tablets, cellular phones, and other items necessary to perform essential functions. For the upcoming biennium, an additional IT allocation was added for the water and wastewater departments' ongoing and critically needed supervisory control and data acquisition (SCADA) project.

(Dollar amounts in thousands: \$100 = \$100,000)

				FY 25	FY 26	BN Total
SCADA				\$ 54	\$ 57	\$ 111
Total Budgeted Expenses less SCADA				\$ 1,435	\$ 1,514	\$ 2,949

Fund	# of Devices	Total	% Allocation	Annual SCADA	FY 25	FY 26	BN Total
General	237	237	67%	\$ -	\$ 965	\$ 1,018	\$ 1,982
Building	9	9	3%	-	37	39	75
SSMP	11	11	3%	-	43	45	88
SAFE	15	15	4%	-	63	66	128
State Gas	11	11	3%	-	46	49	95
Water	29	29	8%	28	146	153	299
Wastewater	17	17	5%	28	97	101	197
Stormwater	23	23	7%	-	95	100	194
	353	353	100%	\$ 56	\$ 1,491	\$ 1,570	\$ 3,060

SUMMARY

Within this biennium, projected operating costs have been reduced in the general fund to plan for future operating needs and the increasing costs that continue to be forecasted. With the reduction in operating costs, the transfers within this biennium are reduced when comparing to prior years. Overall transfers to the general fund are \$13.6 million for the biennium.

In addition to internal service transfers, the general fund and other funds will transfer \$627 thousand and \$238 thousand to the debt service fund, respectively. This cost is related to the new city hall and the annual debt service. The cost driver for this allocation is the total number of FTEs by fund.

The following table outlines the costs by the associated driver between the general fund departments and the other funds.





RS192

City of Milwaukee - Finance Department
Activity Based Costing (ABC) Allocation of Transfers
Biennium Budget 2025-2026

General Fund Departments	Biennium General Fund Operating Budgets	Allocation Cost Driver	General Fund's Portion of the Cost			Total Recalibrated Transfers to the General Fund			Building			SSMP			SAFE			State Gas Tax (Streets)			Water			Wastewater			Stormwater			Construction Excise Tax			Milwaukee Redevelopment District/URA					
			Cost Driver	%	\$	Cost Driver	%	\$	Cost Driver	%	\$	Cost Driver	%	\$	Cost Driver	%	\$	Cost Driver	%	\$	Cost Driver	%	\$	Cost Driver	%	\$	Cost Driver	%	\$	Cost Driver	%	\$	Cost Driver	%	\$			
City Council	\$ 294	No. of FTEs by Function	117.75	73%	\$ 214	31.50	27%	\$ 80	4.0	3%	\$ 8	1.6	1%	\$ 3	1.7	1%	\$ 3	7.4	5%	\$ 14	10.5	7%	\$ 21	6.0	4%	\$ 12	9.7	6%	\$ 19	-	0%	\$ -	-	0%	\$ -			
City Manager	2,992	No. of FTEs by Function	117.75	73%	2,175	31.50	27%	817	4.0	3%	80	1.6	1%	32	1.7	1%	34	7.4	5%	147	10.5	7%	209	6.0	4%	119	9.7	6%	194	-	0%	-	-	0%	-			
City Attorney	747	No. of FTEs by Function	117.75	73%	543	31.50	27%	204	4.0	3%	20	1.6	1%	8	1.7	1%	9	7.4	5%	37	10.5	7%	52	6.0	4%	30	9.7	6%	49	-	0%	-	-	0%	-			
Community Development	1,274	Functions Served	\$ 1,274	68%	872	36,749	32%	402	454	4%	52	-	0%	-	3,106	3%	39	4,044	3%	39	10,048	5%	65	8,132	5%	65	7,254	5%	65	1,948	2%	25	1,763	4%	52			
Public Works:																																						
Administration	2,249	Functions Served	2,249	0%	-	36,236	100%	2,249	-	0%	-	3,652	10%	227	3,106	9%	193	4,044	11%	251	10,048	28%	624	8,132	22%	505	7,254	20%	450	-	0%	-	-	0%	-			
Sustainability & Parks	450	Functions Served	450	60%	270	36,236	40%	180	-	0%	-	3,652	4%	18	3,106	3%	15	4,044	4%	20	10,048	11%	50	8,132	9%	40	7,254	8%	36	-	0%	-	-	0%	-			
Engineering	3,137	Functions Served	0.8	8%	235	9	93%	2,902	-	0%	-	1.6	16%	502	1.7	17%	533	1.4	14%	423	1.5	15%	455	1.5	15%	455	1.7	17%	533	-	0%	-	-	0%	-			
Facilities Management	3,082	Sq Feet ('000)	3,082	90%	2,782	1,459	10%	300	292	1%	20	-	0%	-	-	0%	-	292	2%	74	292	2%	69	292	2%	69	292	2%	69	-	0%	-	-	0%	-			
Finance:																																						
Administration	2,014	Total Budgets	51,009	29%	592	83,948	71%	1,422	2,268	2%	34	8,114	6%	121	14,723	11%	220	10,081	7%	150	14,995	11%	224	20,235	23%	473	13,532	10%	202	-	0%	-	-	0%	-			
Bank/Merchant Charges	420	Budgeted Expenses	420	3%	12	112,729	97%	408	7,234	5%	21	13,624	7%	30	13,619	7%	28	10,259	6%	24	21,347	20%	83	26,779	33%	140	19,866	20%	82	-	0%	-	-	0%	-			
Utility Billing	695	Budgeted Exp.+ Personnel	695	0%	-	52,795	100%	696	-	0%	-	3,698	7%	49	8,630	16%	114	-	0%	-	11,061	21%	146	18,779	36%	247	10,627	20%	140	-	0%	-	-	0%	-			
Fleet Services	1,374	No. of Vehicles/Equip.	1,374	38%	528	138	62%	846	1	0%	6	-	0%	-	-	0%	-	34	15%	209	35	16%	215	26	12%	159	42	19%	258	-	0%	-	-	0%	-			
Human Resources	1,024	No. of FTEs by Function	117.75	73%	744	31.50	27%	280	4.0	3%	27	1.6	1%	11	1.7	1%	12	7.4	5%	50	10.5	7%	72	6.0	4%	41	9.7	6%	67	-	0%	-	-	0%	-			
Information Technology	3,060	No. of Devices	3,060	65%	1,982	116	35%	1,078	9	2%	75	11	3%	88	15	4%	128	11	3%	95	29	10%	299	17	6%	197	23	6%	194	-	0%	-	-	0%	-			
Planning	1,837	Functions Served	1,837	60%	1,102	36,690	40%	735	454	1%	18	3,652	3%	64	3,106	3%	62	4,044	4%	81	10,048	11%	201	8,132	9%	163	7,254	8%	145	-	0%	-	-	0%	-			
Code Enforcement	841	No. of FTEs by Function	117.75	73%	611	31.50	27%	230	4.0	3%	23	1.6	1%	9	1.7	1%	10	7.4	5%	41	10.5	7%	59	6.0	4%	34	9.7	6%	55	-	0%	-	-	0%	-			
City Recorder	1,481	No. of FTEs by Function	117.75	73%	1,077	31.50	27%	404	4.0	3%	40	1.6	1%	16	1.7	1%	17	7.4	5%	73	10.5	7%	104	6.0	4%	59	9.7	6%	96	-	0%	-	-	0%	-			
Non-Departmental	1,347	No. of FTEs by Function	117.75	73%	977	31.50	27%	368	4.0	3%	36	1.6	1%	14	1.7	1%	15	7.4	5%	66	10.5	7%	94	6.0	4%	54	9.7	6%	88	-	0%	-	-	0%	-			
Self-Supported:																																						
Municipal Court	407		407	100%	407																																	
PEG	50		50	100%	50																																	
Library	4,718		4,718	100%	4,718																																	
Police	17,516		17,516	100%	17,516																																	
Totals	\$ 51,009				\$ 37,407		\$ 13,602		\$ 461		\$ 1,192		\$ 1,432		\$ 1,793		\$ 3,041		\$ 2,862		\$ 2,743		\$ 25		\$ 52													
Recalibrated for Rounding																																						
Total Transfer to General Fund						\$ 37,396			\$ 13,613			\$ 458			\$ 1,196			\$ 1,436			\$ 1,797			\$ 3,048			\$ 2,862			\$ 2,740			\$ 25			\$ 50		
Debt Service Fund																																						
City Hall Debt	\$ 865	No. of FTEs	117.75	73%	\$ 629	31.50	27%	\$ 236	4.0	3%	23	1.6	1%	11	1.7	1%	10	7.4	5%	43	10.5	7%	61	6.0	4%	34	9.7	6%	56	-	0%	-	-	0%	-			
Recalibrated for Rounding																																						
Total Transfer to Debt Service Fund						\$ 627			\$ 238			\$ 20			\$ 10			\$ 10			\$ 40			\$ 60			\$ 40			\$ 60			\$ -			\$ -		
TOTAL BIENNIUM TRANSFERS BY FUND						\$ 38,036			\$ 13,851			\$ 478			\$ 1,206			\$ 1,446			\$ 1,837			\$ 3,108			\$ 2,902			\$ 2,800			\$ 25			\$ 50		
			General Fund			All Other Funds			Building			SSMP			SAFE			State Gas Tax (Streets)			Water			Wastewater			Stormwater			Construction Excise Tax			MRC/URA					



RS194

CITY-WIDE OVERALL BUDGET

TOTAL OF ALL FUNDS

(Amounts in Thousands: \$100 = \$100,000)

	HISTORICAL		BN 2023-2024 CURRENT OUTLOOK				BN 2025-2026			
	Actual FY 2021	Actual FY 2022	Amended Budget	Actual FY 2023	Estimated FY 2024	Estimated BN Total	Proposed Total	Approved FY 2025	Approved FY 2026	Approved Total
RESOURCES										
BEGINNING FUND BALANCE	\$ 51,207	\$ 50,012	\$ 50,543	\$ 51,848	\$ 72,570	\$ 51,848	\$ 65,524	\$ 65,524	\$ 42,925	\$ 65,524
Property Taxes	9,910	10,121	21,227	10,568	10,704	21,272	22,290	10,994	11,296	22,290
Fees & Charges	21,721	24,121	49,540	24,795	24,423	49,218	50,625	25,791	24,834	50,625
ROW Licenses & Franchise Fees	3,682	3,542	7,812	3,910	3,941	7,851	9,513	4,458	5,055	9,513
Intergovernmental	6,137	7,807	11,766	5,846	5,855	11,701	26,454	15,682	10,772	26,454
Fines & Forfeitures	417	362	816	459	409	868	835	405	430	835
Interest	232	401	650	1,866	2,014	3,880	1,843	979	864	1,843
Miscellaneous	260	484	604	478	634	1,112	236	131	104	235
Proceeds from debt issuance	-	-	21,000	18,883	-	18,883	-	-	-	-
Lease proceeds	504	489	502	204	-	204	-	-	-	-
Transfers from Other Funds	6,724	6,470	16,023	9,517	7,278	16,795	14,478	7,239	7,240	14,478
TOTAL RESOURCES	\$ 100,794	\$ 103,809	\$ 180,483	\$ 128,374	\$ 127,828	\$ 183,631	\$ 191,798	\$ 131,203	\$ 103,520	\$ 191,798
REQUIREMENTS										
Personnel Services	\$ 18,310	\$ 18,977	\$ 44,135	\$ 19,971	\$ 20,574	\$ 40,545	\$ 45,765	\$ 22,587	\$ 23,178	\$ 45,765
Materials & Services	12,156	13,738	32,304	14,062	15,614	29,676	32,021	16,021	16,000	32,021
Debt Service	3,933	2,598	7,380	3,932	4,103	8,035	8,139	4,053	4,086	8,139
OPERATIONS BEFORE OTHER ITEMS	34,399	35,313	83,819	37,965	40,291	78,256	85,925	42,661	43,264	85,925
Transfers to Other Funds	6,575	6,470	15,808	8,695	7,288	15,983	14,478	7,238	7,240	14,478
Capital Outlay	9,808	10,179	36,149	9,143	14,725	23,868	57,989	38,378	19,611	57,989
TOTAL EXPENDITURES BEFORE RESERVES	50,782	51,962	135,776	55,803	62,304	118,107	158,392	88,277	70,115	158,392
RESERVES										
Contingency	-	-	10,098	-	-	-	2,066	700	2,746	2,746
Unappropriated Ending Fund Balance	50,012	51,848	34,609	72,570	65,524	65,524	31,339	42,225	30,659	30,659
TOTAL RESERVES	50,012	51,848	44,707	72,570	65,524	65,524	33,406	42,925	33,405	33,405
TOTAL REQUIREMENTS	\$ 100,794	\$ 103,809	\$ 180,483	\$ 128,374	\$ 127,828	\$ 183,631	\$ 191,798	\$ 131,203	\$ 103,520	\$ 191,797

	Actual FY 2021	Actual FY 2022	Amended Budget	Actual FY 2023	Estimated FY 2024	Estimated BN Total	Proposed Total	Approved FY 2025	Approved FY 2026	Approved Total
BUDGETED POSITIONS										
Full-Time Equivalent (FTE) Employee #	147.95	149.45	148.75	149.25	149.25	149.25	149.25	150.25	149.25	149.25
Population	20,556	20,600	20,600	21,235	21,235	21,235	21,235	21,235	21,235	21,235
Monthly Operating Costs per Capita	\$ 75	\$ 80	\$ 187	\$ 84	\$ 86	\$ 169	\$ 181	\$ 90	\$ 91	\$ 181



RS196

GENERAL FUND

The General Fund provides the public with the majority of city services including administration and legal services, police protection, code enforcement, library services, development review and regulations. Funding for these services is provided by tax revenue, charges for services, license permits, fines and transfers from the enterprise funds for administrative services provided by the General Fund departments.

(Amounts in Thousands: \$100 = \$100,000)

	HISTORICAL		BN 2023-2024 CURRENT OUTLOOK				BN 2025-2026			
	Actual FY 2021	Actual FY 2022	Amended Budget	Actual FY 2023	Estimated FY 2024	Estimated BN Total	Proposed Total	Approved FY 2025	Approved FY 2026	Approved Total
RESOURCES										
BEGINNING FUND BALANCE	\$ 10,963	\$ 12,077	\$ 16,151	\$ 14,820	\$ 13,423	\$ 14,820	\$ 12,275	\$ 12,275	\$ 10,168	\$ 12,275
Property Taxes	9,048	9,265	19,507	9,708	9,845	19,553	20,576	10,140	10,436	20,576
ROW Licenses & Franchise Taxes:										
PGE	784	825	1,700	860	935	1,795	3,210	1,382	1,829	3,210
NW Natural	255	286	550	384	394	778	1,123	506	618	1,123
Comcast	233	228	450	214	200	414	335	175	160	335
Telecom	759	420	1,300	298	180	478	320	160	160	320
Solid Waste	254	271	540	290	303	593	633	312	321	633
PEG	35	34	63	33	30	63	60	30	30	60
Electric Service Suppliers & Other	132	193	282	368	390	758	810	400	410	810
Intergovernmental:										
Federal Funds - ARPA	-	2,366	75	75	-	75	-	-	-	-
Metro Bond Local Share Grants	-	-	1,127	-	-	-	1,477	667	810	1,477
Library District Dedicated Levy	1,874	1,915	4,164	2,065	2,123	4,188	5,100	2,500	2,600	5,100
State Local Grants										
Seismic	-	-	1,300	-	-	-	1,300	1,300	-	1,300
Solar	-	-	-	-	-	-	375	375	-	375
State Revenue Sharing	1,197	992	2,380	1,000	810	1,810	1,650	820	830	1,650
Other	197	75	487	173	66	239	-	-	-	-
Fines and Forfeitures:										
Traffic & Court	375	298	700	429	390	819	825	400	425	825
Library	1	39	76	26	19	45	10	5	5	10
Other	41	25	40	4	-	4	-	-	-	-
Fees and Charges (Licenses & Permits)	569	646	1,231	594	436	1,030	975	475	500	975
Interest Income	70	108	214	356	548	904	500	250	250	500
Miscellaneous:										
Special Events	-	10	20	-	-	-	-	-	-	-
Lease Financing Agreements	-	-	-	317	-	317	-	-	-	-
Other	55	159	261	-	-	-	-	-	-	-
Sale of Assets	39	60	70	6	287	293	40	20	20	40
Transfers from Other Funds	6,220	6,470	13,785	7,657	6,900	14,557	13,612	6,807	6,807	13,612
TOTAL RESOURCES	\$ 33,101	\$ 36,762	\$ 66,473	\$ 39,677	\$ 37,279	\$ 63,533	\$ 65,208	\$ 39,000	\$ 36,377	\$ 65,208

General Fund continued on the next page

GENERAL FUND SUMMARY (continued)

(Amounts in Thousands: \$100 = \$100,000)

	HISTORICAL		BN 2023-2024 CURRENT OUTLOOK				BN 2025-2026			
	Actual FY 2021	Actual FY 2022	Amended Budget	Actual FY 2023	Estimated FY 2024	Estimated BN Total	Proposed Total	Approved FY 2025	Approved FY 2026	Approved Total
REQUIREMENTS										
Personnel Services	15,323	15,741	37,056	16,665	17,138	33,803	38,109	18,810	19,299	38,109
Materials & Services	4,398	5,299	12,244	5,579	5,679	11,258	12,885	6,385	6,500	12,885
Debt Service	461	481	1,030	505	571	1,076	1,030	504	526	1,030
Capital Outlay	478	422	7,420	1,976	1,318	3,294	3,292	2,820	472	3,292
Transfer Out to Other Funds	364	-	1,756	1,528	298	1,826	627	314	314	627
EXPENDITURE TOTAL	21,024	21,943	59,506	26,253	25,004	51,257	55,943	28,832	27,110	55,943
RESERVES										
Contingency	-	-	2,050	-	-	-	1,737	-	1,737	1,737
UNAPPROPRIATED ENDING FUND BALANCE	12,077	14,820	4,917	13,423	12,275	12,275	7,528	10,168	7,530	7,528
UNAPPROPRIATED RESERVES										
ARPA	-	-	-	-	-	-	-	1,124	-	-
Debt Service	461	481	526	505	505	505	526	504	526	526
Forfeiture	17	36	17	17	17	17	17	17	17	17
PEG	169	177	10	169	69	69	182	177	182	182
Undesignated	11,430	14,126	4,364	12,732	11,684	11,684	6,805	8,346	6,805	6,805
TOTAL RESERVES	12,077	14,820	4,917	13,423	12,275	12,275	7,528	10,168	7,530	7,528
TOTAL REQUIREMENTS	\$ 33,101	\$ 36,762	\$ 66,473	\$ 39,677	\$ 37,279	\$ 63,533	\$ 65,208	\$ 39,000	\$ 36,377	\$ 65,208

BUDGETED POSITIONS	Actual FY 2021	Actual FY 2022	Amended Budget	Actual FY 2023	Estimated		Proposed Total	Approved FY 2025	Approved FY 2026	Approved Total
					FY 2024	BN Total				
Full-Time Equivalent (FTE) Employee #	117.75	119.75	119.75	119.75	119.75	119.75	117.75	118.75	117.75	117.75
Population	20,556	20,600	20,600	21,235	21,235	21,235	21,341	21,341	21,341	21,341
MONTHLY OPERATING COSTS PER CAPITA	\$ 80	\$ 85	\$ 207	\$ 94	\$ 90	\$ 92	\$ 100	\$ 98	\$ 101	\$ 100
POLICY REQUIREMENTS										
Contingency & Ending Fund Balance Above	\$ 12,077	\$ 14,820	\$ 6,967	\$ 13,423	\$ 12,275	\$ 14,270	\$ 9,267	\$ 10,168	\$ 9,267	\$ 9,267
Reserves	647	694	553	691	591	618	725	1,822	725	725
Policy Requirement (25%)	4,374	4,566	6,574	5,252	5,188	11,104	5,803	4,555	5,803	5,803
AMOUNT OVER (UNDER) POLICY REQUIREMENT	\$ 7,056	\$ 9,560	\$ 1,890	\$ 7,480	\$ 6,496	\$ 2,548	\$ 2,739	\$ 3,791	\$ 2,739	\$ 2,739

EXPLANATION OF SIGNIFICANT BUDGET ITEMS

The General Fund decreased by \$1.3 million or -2% when compared to prior biennium budget. Significant items include:

Resources

- 1) Increase of \$1,069,000 or 5% in property taxes from prior biennium budget, due to moving library operations and its property tax allocation into the General Fund. The property tax increase is set by the county assessor's office and is subject to the Measures 5 and 50 limitations.
- 2) Decrease of \$980,000 or 75% in telecom franchise taxes due to actual trends from the current biennium.
- 3) Increase of \$93,000 or 17% in solid waste franchise taxes due to actual trends from the prior biennium.

GENERAL FUND EXPLANATION OF SIGNIFICANT BUDGET ITEMS, CONTINUED

Resources

- 1) Increase of \$1,510,000 or 89% for PGE and \$573,000 or 104% for NW Natural in ROW Licenses & Franchise Taxes, which reflects projected utility rate increases as well as an increase in the ROW license fee on electric and natural gas utility providers from 5% to 8% of gross revenue.
- 2) Holdover of \$1,127,000 of Metro Bond Local Share Grants related to neighborhood parks projects.
- 3) Increase of \$936,000 or 22% as established by the Clackamas County Library District.
- 4) Holdover of \$1,300,000 from local grants for a seismic retrofit of the Public Safety Building. These expenses are outlined in the Facilities Department as well as the Capital Improvement Plan.
- 5) Decrease of \$730,000 or -31% in State Revenue Sharing which encompasses liquor, cigarette, and marijuana tax. These estimates are based on the League of Oregon Cities projected rates multiplied by the city population.
- 6) Increase of \$125,000 or 18% in Traffic & Court due to actual trends from the prior biennium.
- 7) Decrease of \$256,000 or -21% in Fees & Charges which includes liquor licenses, business registrations, parking permits which have seen a decline.
- 8) Decrease of \$173,000 or -1% in Transfers from Other Funds which is outlined in the Transfers section of this budget document.

Expenditures

- 9) Increase of \$1,053,000 or 3% in Personnel Services due to standard cost of living increases and benefit cost increases.
- 10) Increase of \$641,000 or 5% in Materials & Services which is summarized in the department budget details.
- 11) No change in Debt Service due to the amortization schedule. There is no proposed debt added to the General Fund.
- 12) Decrease of \$4,128,000 or -56% in Capital Outlay for several projects. Other large projects are outlined within the department budget detail and the Capital Improvement Plan.
- 13) Decrease of \$1,129,000 or -64% in Transfers to Other Funds is described in detail within the General Government Fund budget (formerly known as non-departmental).



RS200

GENERAL FUND CITY COUNCIL

DEPARTMENT DESCRIPTION AND CORE SERVICES

City Council is responsible for determining the direction and priorities of Milwaukie's municipal government and is comprised of an elected mayor and four elected councilors. The budget for the City Council department accounts for various expenditures incurred by the mayor and councilors, including public meeting broadcast services, stipend expenses, membership dues, trainings and meetings expenses.

- Pursuant to Chapter III, Section 6, of the Milwaukie Charter of 1975 "all powers of the city are vested in the council unless otherwise specifically provided in this charter."
- Pursuant to Chapter VI, Section 20, of the Milwaukie Charter of 1975, the Council is required to "hold a regular meeting at least twice each month in the city at a time and place which it designates."
- The mayor and councilors individually represent the city by their membership on regional forums, such as Metro's Joint Policy Advisory Committee on Transportation and the Clackamas County Coordinating Committee.

ACCOMPLISHMENTS BN 2023-2024

- Adopted updated Downtown Design Review Standards
- Adopted updated Public Contracting Rules
- Authorized grant funding and contracts for parks and infrastructure construction
- Led the move to new city hall
- Consolidated city boards and committees
- Continued to support the city's climate action and equity, justice, and inclusion work
- Adopted a parks improvement goal

PRIORITIES BN 2025-2026



Implement specific actions described in the Milwaukie Community Vision and Action Plan and Climate Action Plan to minimize climate change and increase climate-related resilience



Pursue an entirely equitable Milwaukie by making equity, justice, and inclusion central to the city's policies, priorities, and services



Determine whether and under what terms to leave the North Clackamas Parks and Recreation District and establish a city parks department

FINANCIAL SUMMARY – CITY COUNCIL

(Amounts in Thousands: \$100 = \$100,000)

	HISTORICAL		BN 2023-2024 CURRENT OUTLOOK				BN 2025-2026			
	Actual FY 2021	Actual FY 2022	Amended Budget	Actual FY 2023	Estimated FY 2024	Estimated BN Total	Proposed Total	Approved FY 2025	Approved FY 2026	Approved Total
PERSONNEL SERVICES										
Budgeted FTE Positions	0.0	0.0	0.0	0.0	0.0	0.0	0.0	0.0	0.0	0.0
Council Stipends	\$ 16	\$ 17	\$ 36	\$ 18	\$ 20	\$ 38	\$ 38	\$ 19	\$ 19	\$ 38
Employee Benefits	1	1	4	2	2	4	4	2	2	4
TOTAL PERSONNEL SERVICES	\$ 17	\$ 18	\$ 40	\$ 20	\$ 22	\$ 42	\$ 42	\$ 21	\$ 21	\$ 42
MATERIALS & SERVICES										
Professional & Technical Services:										
Willamette Falls TV	71	77	165	89	80	169	172	86	86	172
Other	-	-	20	-	3	3	14	7	7	14
General Office Supplies	2	2	6	7	2	9	6	3	3	6
Dues & Subscriptions	2	2	4	4	4	8	4	2	2	4
Education & Training:										
Education - Mayor	2	3	10	2	1	3	10	5	5	10
Education - Council #1	-	-	6	1	1	2	6	3	3	6
Education - Council #2	-	-	6	1	1	2	6	3	3	6
Education - Council #3	-	-	6	-	-	-	6	3	3	6
Education - Council #4	-	2	6	-	1	1	6	3	3	6
General Meals & Travel	-	-	10	-	1	1	10	5	5	10
Advertising & Publicity	-	-	6	1	-	1	6	3	3	6
Art Mural Rolling Fund**	26	7	-	-	-	-	-	-	-	-
Events	-	-	6	-	6	6	6	3	3	6
TOTAL MATERIALS & SERVICES	103	93	251	105	100	205	252	126	126	252
City Council Total	\$ 120	\$ 111	\$ 291	\$ 125	\$ 122	\$ 247	\$ 294	\$ 147	\$ 147	\$ 294

* Council Stipends is \$369 per month for the Mayor and \$307 per month for Councilors.
 ** Art Fund moved to City Manager's Office budget.



GENERAL FUND CITY MANAGER

DEPARTMENT DESCRIPTION AND CORE SERVICES

The city manager's office efficiently and effectively oversees all city operations and implements policy decisions of the City Council, while working with internal and external groups to meet the needs of the community. The city manager's core services include:

- Advising the Council of affairs and needs of the city
- Ensuring all ordinances are enforced and the provisions of franchises, leases, contracts, permits and privileges granted by the city are fully observed
- Appointment and removal of all city officers and employees, and general supervision and control over them and their work
- Acting as purchasing agent and budget officer for the city
- Control of all public utilities owned and operated by the city, and general supervision over all city-owned property
- Other duties required by the Milwaukie City Charter or Council

The Strategic Engagement Team (SET), a division with the city manager's office, is responsible for:

- Managing the city's primary communication and engagement channels, including the city website, social media accounts, and *Engage Milwaukie* platform
- Working collaboratively with departments to develop communication and engagement strategies for city programs and projects
- Leading the city's signature event programs and working with community members to facilitate permitting of community-sponsored events
- Coordinating the city's equity and inclusion efforts, including staff trainings, resource development, and multicultural event support
- Establishing and maintaining the city's branding standards
- Managing the city's emergency planning and response program in coordination with police and public works
- Managing the city's neighborhood district association (NDA) program including administration of annual grant funds
- Working with the Milwaukie Arts Committee and community partners to manage the sculpture garden, showcase art on city property, and administer funding for public art



ACCOMPLISHMENTS BN 2023-2024

- Hosted city signature events – including Umbrella Parade and Winter Solstice – attracting thousands of participants -- and permitted dozens of community-led events and activities in public right-of-way.
- Maintained the city's communication channels, growing engagement to 132,500 return website visitors, 5.9 thousand followers on Facebook, and more than 1,250 registered users of *Engage Milwaukie* in FY24.
- Delivered 22 editions of the *Milwaukie Pilot* newsletter, including Spanish translations monthly.
- Supported Council's equity, inclusion and justice goal, including establishing an Equity Steering Committee of community volunteers, contracting for a comprehensive equity assessment of city services, and developing a multi-year equity work plan.
- Developed *Milwaukie Momentum*, an organizational 2024-2027 strategic plan to guide operational improvements within the city's departments.
- Facilitated the Milwaukie Leadership Academy each year, educating cohorts of community members on how government functions.
- Supported internal communications and culture building, including organizing seven quarterly all-hands meetings.
- Created templates for Council to communicate progress on its adopted goals.
- Helped oversee the successful relocation from historic city hall building to new city hall.

PRIORITIES BN 2025-2026



Implement the multi-year equity work plan focusing on internal trainings and resource development, supporting the Equity Steering Committee's goals, and application of equity framework on major citywide initiatives



Refresh the city's website to improve usability and better enable constituents to access the information needed



Improve internal communications by supporting more cross-departmental collaboration, information sharing, and process improvement



Oversee implementation and evaluate efficacy of *Milwaukie Momentum*



Evolve the city's annual events program to more strategically allocate resources and expand programming throughout the year and across the city



Continue supporting the city's NDA program, facilitating updates to NDA program policies and guidelines that better enable neighborhoods to achieve their goals.



Support establishment of cooling, warming, and stabilization centers to support people in crisis



Update the city's Emergency Operations Plan and Continuity of Operations Plan

PERFORMANCE MEASURES

Value	Metric	FY 2021	FY 2022	FY 2023	Estimated		
					FY 2024	FY 2025	FY 2026
Equitable	# of equity steering committee meetings held	n/a	10	10	10	10	10
	# of equity-focused trainings put on for staff	n/a	4	4	3	3	3
Accessible	# return visits to city website	118,881	125,814	130,412	132,500	135,000	137,500
	# of social media posts	110	123	128	140	155	180
Efficient	# of temporary event permit applications processed	10	21	37	45	50	50
	% of City Council meetings concluding by 9pm	74%	58%	58%	76%	66%	66%
Accountable	# of City Council meetings attended	73	84	81	74	76	76
	# of hours recorded of City Council meetings	130	147	144	125	140	140
Collaborative	# of events produced & coordinated	8	8	7	8	8	8
	# of sponsorships and donations secured	2	4	0	3	10	10
	# of city marketing collateral prepared	50	55	70	75	80	85
	# of event marketing collateral prepared	60	60	65	70	75	80
	# of NDA marketing collateral prepared	2	4	5	5	5	5
	# of registered users on Engage Milwaukie	729	1,098	1,172	1,250	1,325	1,400



FINANCIAL SUMMARY – CITY MANAGER

(Amounts in Thousands: \$100 = \$100,000)

	HISTORICAL		BN 2023-2024 CURRENT OUTLOOK				BN 2025-2026			
	Actual FY 2021	Actual FY 2022	Amended Budget	Actual FY 2023	Estimated FY 2024	Estimated BN Total	Proposed Total	Approved FY 2025	Approved FY 2026	Approved Total
PERSONNEL SERVICES										
Budgeted FTE Positions	8.0	7.0	8.0	8.0	8.0	8.0	6.5	6.5	6.5	6.5
Salaries & Wages	\$ 644	\$ 666	\$ 1,814	\$ 768	\$ 853	\$ 1,621	\$ 1,538	\$ 758	\$ 780	\$ 1,538
Employee Benefits	343	384	1,032	429	478	907	860	425	435	860
TOTAL PERSONNEL SERVICES	\$ 987	\$ 1,050	\$ 2,846	\$ 1,197	\$ 1,331	\$ 2,528	\$ 2,398	\$ 1,183	\$ 1,215	\$ 2,398
MATERIALS & SERVICES										
Professional & Technical Services:	19	73	238	115	94	209	201			
General Office Supplies	1	3	13	14	6	20	12	7	5	12
Dues & Subscriptions	5	7	12	7	7	14	14	7	7	14
Education & Training	28	15	19	11	11	22	28	14	14	28
Advertising & Publicity	85	94	177	86	90	176	177	88	89	177
Events	10	54	86	63	36	99	104	52	52	104
Public Arts & Rolling Mural Fund	4	3	35	18	15	33	40	20	20	40
Miscellaneous	-	2	14	5	7	12	18	9	9	18
TOTAL MATERIALS & SERVICES	152	251	594	319	266	585	594	305	289	594
CAPITAL OUTLAY										
Vehicle	-	37	80	40	-	40	-	-	-	-
TOTAL CAPITAL OUTLAY	-	37	80	40	-	40	-	-	-	-
CITY MANAGER TOTAL	\$ 1,139	\$ 1,338	\$ 3,520	\$ 1,556	\$ 1,597	\$ 3,153	\$ 2,992	\$ 1,488	\$ 1,504	\$ 2,992

GENERAL FUND CITY ATTORNEY

DEPARTMENT DESCRIPTION AND CORE SERVICES

Per the Milwaukie City Charter, the city attorney is an officer of the city appointed by the City Council. The city attorney is the legal advisor to Council, city officials, departments, and the city's boards and commissions.

In 2018, the Council successfully selected and appointed an in-house city attorney. The city attorney provides legal support and expertise in many areas of legal matters, including election law, Council agenda support, the city's legislative agenda, litigation matters, and changes in federal, state, and local laws. Additionally, the city attorney maintains and manages external contracts for supplemental legal services when capacity or a required expertise in a specialty area is needed.

ACCOMPLISHMENTS BN 2023-2024

Provided timely and accurate legal support to Council and staff that exceeded expectations, reduced or eliminated potential liability, and promoted efficient and effective government.

PRIORITIES BN 2025-2026



Advise Council, commissions, boards, and committees on matters coming before them in performance of duties and relevant changes in the law



Advise city manager, city management and staff on legal affairs of the city and other agencies, and the status of laws



Represent the city and its boards, commissions, committees, and officers on all legal matters in litigation, appeals and administrative proceedings, as well as monitor and assist with legal proceedings handled by outside counsel



Draft and review ordinances, codes, resolutions, contracts, and orders for Council



Draft and review letters and other legal documents for the city manager and city departments



Conduct legal research and prepare memoranda on a wide range of topics and concerns



Represent and advise the city in intergovernmental relations and code enforcement activities



Assist in ensuring compliance with state and federal election requirements



Provide updates and training regarding legislation and recommend changes in city policies and practices to comply with federal, state, and local laws

FINANCIAL SUMMARY – CITY ATTORNEY

(Amounts in Thousands: \$100 = \$100,000)

	HISTORICAL		BN 2023-2024 CURRENT OUTLOOK				BN 2025-2026			
	Actual FY 2021	Actual FY 2022	Amended Budget	Actual FY 2023	Estimated FY 2024	Estimated BN Total	Proposed Total	Approved FY 2025	Approved FY 2026	Approved Total
PERSONNEL SERVICES										
Budgeted FTE Positions	1.0	1.0	1.0	1.0	1.0	1.0	1.0	1.0	1.0	1.0
Salaries & Wages	\$ 134	\$ 153	\$ 349	\$ 163	\$ 168	\$ 331	\$ 349	\$ 172	\$ 177	\$ 349
Employee Benefits	60	71	163	74	77	151	166	82	84	166
TOTAL PERSONNEL SERVICES	194	224	\$ 512	\$ 237	\$ 245	\$ 482	\$ 515	\$ 254	\$ 261	\$ 515
MATERIALS & SERVICES										
Professional & Technical Services	13	-	226	93	90	183	226	113	113	226
General Office Supplies	-	-	2	-	1	1	2	1	1	2
Dues & Subscriptions	1	1	2	1	1	2	2	1	1	2
Education & Training	1	1	2	1	1	2	2	1	1	2
TOTAL MATERIALS & SERVICES	15	2	232	95	93	188	232	116	116	232
CITY ATTORNEY TOTAL	\$ 209	\$ 226	\$ 744	\$ 332	\$ 338	\$ 670	\$ 747	\$ 370	\$ 377	\$ 747



GENERAL FUND

COMMUNITY DEVELOPMENT

DEPARTMENT DESCRIPTION AND CORE SERVICES

The Community Development Department ensures the physical development within the city is aligned with community goals and values, and complies with local, regional, state, and federal laws to ensure that Milwaukie is a safe, equitable, livable, and sustainable city.

The Community Development Department provides management and administrative support for other city departments, including Building, Planning, Engineering, and the Urban Renewal Agency, and is primarily responsible for implementing economic development and housing-related activities for the city. The department works with local businesses to help retain and assist with expansion plans of existing businesses and provide information to those looking to call Milwaukie their home. Through policy and program development, the Community Development Department addresses the important needs of the business community.

The department is responsible for the following core services:

- Lead community development activities that support and implement the city's 20-year Vision and Comprehensive Plans
- Ensure compliance with all regional and state laws that regulate development within city limits
- Oversee administration of local land use laws and zoning regulations
- Manage public-facing services that result in development of the built environment
- Coordinate and manage planning projects related to land use and transportation
- Partner with state, regional, county, and local non-profit partners to address growth issues and regionally significant transportation projects
- Collaborate with other city departments to guide infrastructure investments, service delivery, and enhancements
- Facilitate inclusive and collaborative community engagement
- Provide incentives and partnership opportunities for public, private, and non-profit partners to develop high-quality housing choices for residents of all income levels and needs
- Leverage public and private partnerships to deliver on community goals
- Create and administer economic development programs and incentives that support the local business community
- Partner with state and regional economic development agencies to develop business retention, expansion, and attraction initiatives
- Assist in implementation of the city's Urban Renewal Plan

ACCOMPLISHMENTS BN 2023-2024

- Partnered with Northwest Housing Alternatives to administer \$75,000 in rental assistance grants that supported over two dozen local families in remaining housed
- Developed and implemented the city's inaugural Affordable Housing Grant Program that awarded \$2,000,000 in Construction Excise Tax (CET) funds to support the creation of over 400 income-restricted units, most of which are restricted at low and very-low area median income limits

ACCOMPLISHMENTS BN 2023-2024 (CONTINUED)

- Updated a housing capacity analysis and developed a housing production strategy as required by House Bill 2003, made possible through a grant awarded by Oregon Department of Land Conservation & Development
- Continued Coho Point development efforts, including land use entitlements, draft shared parking agreement, draft affordability covenant, and vertical housing development zone pre-approval
- Approved a Five-Year Urban Renewal Implementation Plan and began collaborating with the Milwaukie Redevelopment Commission Community Advisory Committee to create and implement the economic development-based programs
- Oversaw the entire construction process for new city hall, which allowed several city departments to consolidate within a single building and modernize operations
- Finalized a long-term lease for the parking lot between new city hall and the library to provide more access for the public and city employees
- Surplused the historic city hall building and issued a competitive solicitation to select a buyer that would achieve the goals of Council. Later closed on the sale of historic city hall and ensured the façade will remain preserved in perpetuity.
- Continued to maintain uninterrupted land use and development review processes with record-breaking permitting during unprecedented transition
- Oversaw the coordination efforts for record-breaking building permitting and large-scale planning projects, such as the Bonaventure (170 units), Henley Estates (178 units), Monroe Apartments (234 units), Hillside Park Phase I (275 units), and Coho Point (195 units)

PRIORITIES BN 2025-2026



Implement additional online application tools to help integrate permitting processes and provide better response times and services to customers



Create and implement economic development programs, such as pre-development assistance, store front improvements, and tenant improvements, using Tax Increment Finance (TIF) dollars for properties in the URA and CET funds for properties outside the urban renewal area related to the Neighborhood Hubs program



Monitor and track the CET-funded affordable housing projects to ensure the developers are meeting obligations in creating more housing opportunities to residents of varying socio-economic backgrounds



Continue implementation of the housing production strategy to support additional housing options for Milwaukie residents of all socio-economic backgrounds and remain in conformance with new state requirements



Monitor and confirm the new owner of historic city hall fulfills their obligations and city goals



Develop a new Transportation System Plan and monitor the Downtown Parking Management program to assist in reducing vehicle trips, greenhouse gas emissions, and pedestrian/bicycle safety



Accurately leverage outside agencies, organizations, and businesses to support community development functions to enhance the city's limited resources and provide more services



Continue to market city-owned opportunity sites for the purpose of developing a public benefit such as affordable housing or open space



Cultivate a thriving work environment that is inclusive, healthy, and productive for everyone

CHANGES TO SERVICE

The Community Development Department lost its housing and economic development program manager position. This position was transitioned over to the Building Department in order to help fulfill a long-standing need for additional resources. The community development director has been the primary lead for all economic development and housing related work since September 2022.

PERFORMANCE MEASURES

Value	Metric	FY 2021	FY 2022	FY 2023	Estimated		
					FY 2024	FY 2025	FY 2026
Accessible	# of existing and prospective businesses visited/contacted	45	30	30	50	50	50
	# of businesses relocated or assisted	15	10	25	25	30	30
	# of new businesses in Milwaukie	20	22	29	25	25	25
Accountable	\$ amount city taxable assessed value (in millions)	2,240	2,315	2,385	2,503	2,578	2,655
	\$ value of resources secured for community projects (in thousands)	15	100	75	100	100	100

FINANCIAL SUMMARY – COMMUNITY DEVELOPMENT

(Amounts in Thousands: \$100 = \$100,000)

	HISTORICAL		BN 2023-2024 CURRENT OUTLOOK				BN 2025-2026			
	Actual FY 2021	Actual FY 2022	Amended Budget	Actual FY 2023	Estimated FY 2024	Estimated BN Total	Proposed Total	Approved FY 2025	Approved FY 2026	Approved Total
PERSONNEL SERVICES										
Budgeted FTE Positions	4.5	4.5	5.5	5.5	5.5	5.5	2.0	2.0	2.0	2.0
Salaries & Wages	\$ 370	\$ 323	\$ 779	\$ 329	\$ 314	\$ 643	\$ 534	263	271	\$ 534
Employee Benefits	190	169	623	174	183	357	298	147	151	298
TOTAL PERSONNEL SERVICES	\$ 560	\$ 492	\$ 1,402	\$ 503	\$ 497	\$ 1,000	\$ 832	\$ 410	\$ 422	\$ 832
MATERIALS & SERVICES										
Professional & Technical Services	48	23	286	60	60	120	250	125	125	250
General Office Supplies	2	8	8	4	6	10	8	4	4	8
Dues & Subscriptions	5	2	16	3	1	4	12	6	6	12
Education & Training	1	-	10	-	1	1	8	4	4	8
Printing Costs	-	-	2	-	1	1	2	1	1	2
Economic Development	32	8	100	2	30	32	100	50	50	100
Rental Assistance (ARPA Funded)	50	-	75	75	-	75	-	-	-	-
Miscellaneous	-	1	2	1	1	2	62	61	1	62
TOTAL MATERIALS & SERVICES	138	42	499	145	100	245	442	251	191	442
CAPITAL OUTLAY										
Vehicles & Equipment	-	20	-	-	-	-	-	-	-	-
Landbanking	16	-	100	85	-	85	-	-	-	-
Construction in Progress	-	97	-	-	-	-	-	-	-	-
TOTAL CAPITAL OUTLAY	16	117	100	85	-	85	-	-	-	-
COMMUNITY DEVELOPMENT TOTAL	\$ 714	\$ 651	\$ 2,001	\$ 733	\$ 597	\$ 1,330	\$ 1,274	\$ 661	\$ 613	\$ 1,274



RS212

GENERAL FUND

PUBLIC WORKS ADMIN

DEPARTMENT DESCRIPTION AND CORE SERVICES

The Public Works Department is dedicated to maintaining and improving the quality of life in Milwaukie by planning for future needs, promoting environmental quality, building, and maintaining municipal infrastructure, and protecting health and safety. Public Works is entrusted with these responsibilities in partnership with the citizens, customers and system users for the benefit, welfare and safety of the community and the environment.

The Public Works Department oversees the development and management of operations and maintenance of the city's infrastructure and utility systems, administers both the city's Climate Action Plan (CAP) and Urban Forest Management Plan, and facilitates inter-departmental collaboration to support climate and urban forest goals and efforts. Public Works also provides management and administrative support to the Fleet Services and Facilities Management divisions in the General Fund, as well as the four utility divisions of Water, Wastewater, Stormwater, and Transportation. The Public Works Department carries out the following functions:

- Manage, budget, and provide financial oversight of four utility funds (including rate structure) and the Fleet and Facilities divisions
- Manage and implement CAP
- Administer Milwaukie's urban forest and implement the Urban Forest Management Plan
- Manage and track infrastructure assets
- Data maintenance, design, spatial analysis and research, map production, and web application development for geographic information systems (GIS)

ACCOMPLISHMENTS BN 2023-2024

- Created strategic and equitable engagement with the community for design and construction of Bowman Brae, Balfour, and Scott Parks through surveys and inclusion in design workshops
- Updated CAP to include an updated greenhouse gas inventory
- Partnered with Portland General Electric to transition to 100% carbon-free electricity for city buildings and operational uses
- Implemented new global positioning system workflows and technology solutions
- Enhanced GIS data through integrating property information with new permitting software, updating landscape maps, supporting city/neighborhood boundary integration with planning, police system, updating snow plowing data in maps and systems, and providing project support for lead removal water project
- Assisted Planning Department with zoning amendments and neighborhood hubs project support
- Implemented a new private tree permitting process, provided tree canopy analysis, and developed new urban forest outreach materials to align with the adopted code and to increase preservation and plantings of trees on private residential properties and new construction
- Coordinated with local environmental organizations and utilities to hold an Earth Day event to promote local climate action and increase community education of environmental and climate-forward opportunities
- Hosted local Arbor Day celebrations in 2022 and 2023 with over 100 community members and volunteers in attendance and over 260 trees planted in the community

PRIORITIES BN 2025-2026



Implement new permitting system to streamline the erosion control permit application process



Engage stakeholders and initiate design of new residential and small commercial voluntary carbon-free electricity product to align with community and Council climate goals



Develop a climate program funding mechanism to assist in long-term funding strategies



Complete construction of Bowman Brae, Balfour, and Scott Parks



Develop new right-of-way and easement GIS layer to provide updated and accurate information for planning, engineering, and public works



Work with Finance Department to update impervious surface area data in the utility billing system and communicate changes to utility customers

PERFORMANCE MEASURES

Value	Metric	FY 2021	FY 2022	FY 2023	Estimated		
					FY 2024	FY 2025	FY 2026
Accountable	# of trees planted	1,363	335	146	180	200	250
	\$ amount of urban forestry expenditures per capita	26	19	30	30	30	30
	# of public and private trees in city inventory database	1,431	1,457	1,604	1,700	1,800	1,900
	% of residential accounts enrolled in renewable electricity products through PGE	34%	34%	34%	35%	36%	37%
	% of commercial accounts enrolled in renewable electricity products through PGE	5%	5%	5%	5%	6%	6%
	% of large industrial accounts enrolled in renewable electricity products through PGE	3.1%	3.1%	3.2%	3.3%	3%	4%
Accessible	# of public charging stations in Milwaukie	14	14	17	32	32	42
Collaborative	# of volunteer hours devoted to tree work	646	670	520	600	600	600
Efficient	# of solar permits processed	53	20	70	50	50	50

FINANCIAL SUMMARY – PUBLIC WORKS ADMIN

(Amounts in Thousands: \$100 = \$100,000)

	HISTORICAL		BN 2023-2024 CURRENT OUTLOOK				BN 2025-2026			
	Actual FY 2021	Actual FY 2022	Amended Budget	Actual FY 2023	Estimated FY 2024	Estimated BN Total	Proposed Total	Approved FY 2025	Approved FY 2026	Approved Total
PERSONNEL SERVICES										
Budgeted FTE Positions	7.0	6.0	8.0	7.0	8.0	8.0	7.0	8.0	7.0	7.0
Salaries & Wages	\$ 567	\$ 623	\$ 1,486	\$ 689	\$ 715	\$ 1,404	\$ 1,438	\$ 732	\$ 706	\$ 1,438
Employee Benefits	338	353	900	376	400	776	916	465	451	916
TOTAL PERSONNEL SERVICES	\$ 905	\$ 976	\$ 2,386	\$ 1,065	\$ 1,115	\$ 2,180	\$ 2,354	\$ 1,197	\$ 1,157	\$ 2,354
MATERIALS & SERVICES										
Professional & Technical Services	5	35	205	125	10	135	186	93	93	186
General Office Supplies	2	5	12	8	16	24	13	6	7	13
Dues & Subscriptions	2	2	6	3	1	4	5	2	3	5
Education & Training	3	4	28	5	7	12	20	10	10	20
Printing Costs	-	5	4	0	-	0	3	2	1	3
Sustainability	2	35	60	20	20	40	60	30	30	60
Emergency Operations	21	23	50	23	50	73	58	30	28	58
Miscellaneous	2	6	2	28	30	58	-	-	-	-
TOTAL MATERIALS & SERVICES	37	115	367	212	134	346	345	173	172	345
CAPITAL OUTLAY										
Vehicles & Equipment	-	-	-	-	-	-	70	70	-	70
Construction in Progress	-	-	3,707	218	300	518	1,130	1,070	60	1,130
TOTAL CAPITAL OUTLAY	-	-	3,707	218	300	518	1,200	1,140	60	1,200
PUBLIC WORKS ADMINISTRATION TOTAL	\$ 942	\$ 1,091	\$ 6,460	\$ 1,495	\$ 1,549	\$ 3,044	\$ 3,899	\$ 2,510	\$ 1,389	\$ 3,899





RS216

GENERAL FUND

ENGINEERING SERVICES

DEPARTMENT DESCRIPTION AND CORE SERVICES

The Engineering Services Department delivers high-quality capital improvement projects, supports the Planning and Community Development Departments with the engineering facets of private development projects, supports the development of infrastructure standards, and implements city policies within the public right-of-way and other public facilities. Engineering Services ensures that community needs – especially long-term needs – are provided at the lowest cost to ratepayers.

The Engineering Services Department manages the Capital Improvement Plan (CIP) for the city's utility and transportation systems, where guidance for the CIP is provided by adopted system plans. The department is responsible for the following core services:

- Implement a 6-year CIP plan that provides for timely construction of projects needed to maintain, expand, or improve facilities, utilities, and transportation systems within the city.
- Provide assistance to the Public Works Department and oversee design and construction of all improvements within the public right-of-way
- Manage the public right-of-way, including permitting administration through capital improvement projects, franchise utility work, and private developments
- Assist the Planning and Building Departments with engineering requirements for land use applications, review and approve design plans, inspect new construction, and calculate system development charges required for private development projects
- Support the Planning Department by drafting new system plans for Transportation, Stormwater, Water, and Wastewater
- Administer the Safe Access For Everyone (SAFE) program by constructing 57 miles of sidewalks, trails, and bike paths
- Manage the Street Surface Maintenance Program (SSMP) which maintains, resurfaces, and rebuilds the streets throughout Milwaukie











ACCOMPLISHMENTS BN 2023-2024

- Initiated design work for King Road Improvements, 26th Avenue Improvements, Waverly Heights Sewer System Reconfiguration, Waverly South, Monroe Street Greenway, and the Logus Road, 40th and 42nd Avenue Improvements projects
- Started construction projects for Meek Street Improvements North Phase and Washington Street Area Improvements
- Completed construction for 42nd & 43rd Avenue and Howe Road SAFE project, Home Avenue SAFE project (King Road to Railroad Avenue), Wood Avenue Reconstruction, Wastewater System Improvements, 2023 Slurry/Crack Seal SSMP, and 2023 Grind and Inlay SSMP projects
- Supported completion of private development projects, including the Seven Acres Apartments, Elk Rock Estates, Walnut Addition, Henley Place Apartments, and Birnam Oaks Apartments
- Began construction for private development projects including Hillside Development Phase I, Bonaventure Senior Living, and the 52nd and Jackson Townhouses
- Entered into a grant agreement with Oregon Department of Transportation (ODOT) for the design of Monroe Street Greenway (21st Avenue to 34th Avenue)
- Worked with Public Works Department on National Pollutant Discharge Elimination System annual report to provide data for upgrades made to our stormwater system citywide

ACCOMPLISHMENTS BN 2023-2024 (CONTINUED)

- Acquired a new 1200-CA Stormwater General Discharge Permit with the Oregon Department of Environmental Quality covering all capital improvement projects through September 2027
- Reviewed, approved, and inspected 20 private development projects
- Provided support and information to the Public Safety Advisory Committee and Citizens Utility Advisory Board

PRIORITIES BN 2025-2026

-  Review system plans, utility rates, and system development charges to ensure the CIP aligns with the city's needs
-  Provide engineering support to Planning Department in updating Transportation System Plan
-  Review all transportation projects, including cost adjustments for inflation and verification the work is consistent with Council's goals and project objectives
-  Complete construction projects for Meek Street Improvements (North Phase), Washington Street Area Improvements, King Road Improvements, 26th Avenue Improvements, Waverly Heights Sewer System Reconfiguration, and Waverly South
-  Support private development construction of Coho Point Apartments, Dogwood Station Apartments, Bonaventure Senior Living, 52nd and Jackson Townhouses, Harder Mechanical Expansion (with improvements to Hanna Harvester Dr.), Hillside Master Plan Redevelopment, Railroad Estates Subdivision, and other projects as needed
-  Partner with ODOT to complete the design of Monroe Street Neighborhood Greenway project and begin construction
-  Provide continued support of the city's utilities and transportation needs, including increased downtown safety and appeal and supporting implementation of a 23-hour stabilization center
-  Seek additional funding to complete other projects identified within system plans and administer any grants awarded to the city
-  Work towards having projects shovel-ready to take advantage of alternative funding sources
-  Complete continuing education, training, and development to maintain licensure, cross-training duties, and stay current with civil engineering practices that support all department staffing levels



PERFORMANCE MEASURES

Value	Metric	FY 2021	FY 2022	FY 2023	Estimated		
					FY 2024	FY 2025	FY 2026
Collaborative	# of hours with technical groups and NDAs	520	525	500	520	525	530
Accountable	# of capital projects completed citywide	3	2	3	5	6	5
	# of public improvement reviews	3	2	3	4	3	4
	# of lane miles asphalt placed (SSMP)	1.76	3.62	3.63	3.02	5.97	6.24
	# of lane miles of sidewalk, walkways, and bike lanes placed (SAFE)	0.94	5.32	2.71	0.14	0.94	3.23
Efficient	# of right-of-way permits	153	124	91	100	110	115
	# of franchise permits	142	141	153	140	145	150
Equitable	# of ADA ramps installed (SAFE)	30	50	76	14	38	136

FINANCIAL SUMMARY – ENGINEERING SERVICES

(Amounts in Thousands: \$100 = \$100,000)

	HISTORICAL		BN 2023-2024 CURRENT OUTLOOK				BN 2025-2026			
	Actual FY 2021	Actual FY 2022	Amended Budget	Actual FY 2023	Estimated FY 2024	Estimated BN Total	Proposed Total	Approved FY 2025	Approved FY 2026	Approved Total
PERSONNEL SERVICES										
Budgeted FTE Positions	10.5	10.5	10.5	10.5	10.5	10.5	10.0	10.0	10.0	10.0
Salaries & Wages	\$ 858	\$ 844	\$ 2,074	\$ 829	\$ 962	\$ 1,791	\$ 2,005	988	1,017	\$ 2,005
Employee Benefits	453	426	1,184	422	477	899	998	493	505	998
TOTAL PERSONNEL SERVICES	\$ 1,311	\$ 1,270	\$ 3,258	\$ 1,251	\$ 1,439	\$ 2,690	\$ 3,003	\$ 1,481	\$ 1,522	\$ 3,003
MATERIALS & SERVICES										
Professional & Technical Services	-	3	50	13	18	31	50	25	25	50
General Office Supplies	5	3	18	4	5	9	12	6	6	12
Fees & Licenses	1	-	4	4	1	5	4	2	2	4
Dues & Subscriptions	-	4	4	4	4	8	6	3	3	6
Education & Training	11	19	27	12	9	21	30	15	15	30
Miscellaneous	1	13	37	4	5	9	32	16	16	32
TOTAL MATERIALS & SERVICES	18	42	140	41	42	83	134	67	67	134
CAPITAL OUTLAY										
Construction in Progress	-	-	700	425	-	425	-	-	-	-
TOTAL CAPITAL OUTLAY	-	-	700	425	-	425	-	-	-	-
ENGINEERING SERVICES TOTAL	\$ 1,329	\$ 1,312	\$ 4,098	\$ 1,717	\$ 1,481	\$ 3,198	\$ 3,137	\$ 1,548	\$ 1,589	\$ 3,137



RS220

GENERAL FUND

FACILITIES MANAGEMENT

DEPARTMENT DESCRIPTION AND CORE SERVICES

The Facilities Management Department maintains and improves all city-owned buildings and properties. The department assesses condition and budgets, plans, and prioritizes projects that demonstrate effective stewardship of public resources and supports the greater city goals and vision. The Facilities Management provides clear communication, stellar customer service, timeliness, and efficiency for the following core services:

- Maintain, repair, construct, and oversee remodeling and repairs of buildings and properties
- Recommend scope and manage facility capital projects and funding uses
- Recommend solutions for increased energy efficiency
- Align goals with the city's Climate Action Plan and pursue greater results through participation in Energy Trust of Oregon's Strategic Energy Management Program to reduce energy use
- Monitor and report energy use, trends, and opportunities
- Perform preventive maintenance activities to ensure buildings and systems function properly to protect and preserve city assets
- Provide comfortable, secure, and clean work areas for city employees
- Provide on-call service 24/7/365
- Perform general contracting work for repair and improvement projects, including heating, ventilation, and air conditioning (HVAC), security, janitorial, structural, landscaping, painting, electrical, plumbing, remodeling, and office reconfigurations

ACCOMPLISHMENTS BN 2023-2024

- Managed renovations for new city hall building to accommodate consolidated city staff and enhance community uses
- Remodeled former community development building to expand office space for public works administrative staff, including new flooring, furniture, customer service counter, and technology upgrades
- Decommissioned two underground fuel tanks and installed one aboveground fuel tank at the public works campus
- Installed three public-facing electric vehicle (EV) charging stations at the Ledding Library, Public Safety Building, and Johnson Creek Campus to encourage EV adoption and lower the city's carbon footprint
- Installed two fleet-facing EV charging stations at new city hall
- Completed design work and began construction on the Public Safety Building seismic retrofits in relation to the grant awarded by the State of Oregon Seismic Rehabilitation Grant Program
- Completed over 2,200 work orders for various facility needs such as HVAC, electrical, fire alarm, graffiti removal, locksmith services, and more

PRIORITIES BN 2025-2026



Install new HVAC controls at city hall to improve temperature control and to reduce energy consumption



Renovate two bathrooms at public work facility to include ADA improvements



Install bollards below and above surface level at the Ledding Library to provide safety to pedestrians and the building



Install solar array at the public works facility to offset energy usage and further the city's decarbonization goals

CHANGES TO SERVICE

The move into the new city hall significantly increased the amount of space managed by the department. As a result, staff expects continued increased workload in the 2025-2026 biennium and will continue to review priorities to maintain all city-owned facility needs.

PERFORMANCE MEASURES

Value	Metric	FY 2021	FY 2022	FY 2023	Estimated		
					FY 2024	FY 2025	FY 2026
Efficient	# of work orders completed	1,103	1,196	1,132	1,144	1,144	1,144
	% of electricity savings in kWh	10%	3%	5%	2%	2%	2%
	% of natural gas savings	12%	18%	5%	11%	11%	11%
	# therms used per 100 cubic feet of natural gas	18,682	19,767	23,429	21,589	21,589	21,589
Accountable	# of sq. feet of managed city building space	80,000	80,000	98,000	98,000	98,000	98,000



FINANCIAL SUMMARY – FACILITIES MANAGEMENT

(Amounts in Thousands: \$100 = \$100,000)	HISTORICAL		BN 2023-2024 CURRENT OUTLOOK			BN 2025-2026				
	Actual FY 2021	Actual FY 2022	Amended Budget	Actual FY 2023	Estimated FY 2024	Estimated BN Total	Proposed Total	Approved FY 2025	Approved FY 2026	Approved Total
PERSONNEL SERVICES										
Budgeted FTE Positions	3.0	3.0	3.0	3.0	3.0	3.0	3.0	3.0	3.0	3.0
Salaries & Wages	\$ 239	\$ 275	\$ 533	\$ 263	\$ 249	\$ 512	\$ 570	\$ 281	\$ 289	\$ 570
Employee Benefits	147	166	347	165	163	328	375	186	189	375
TOTAL PERSONNEL SERVICES	\$ 386	\$ 441	\$ 880	\$ 428	\$ 412	\$ 840	\$ 945	\$ 467	\$ 478	\$ 945
MATERIALS & SERVICES										
Professional & Technical Services:										
Electricians	12	6	20	9	2	11	20	10	10	20
HVAC	12	52	40	72	50	122	70	35	35	70
Landscape	94	131	300	165	146	311	340	170	170	340
Painting	1	-	40	-	3	3	15	7	8	15
Plumbing	12	1	20	7	19	26	25	10	15	25
Preventative Care	5	20	13	10	12	22	20	10	10	20
Repairs	10	6	70	19	40	59	70	35	35	70
Other	76	123	95	106	42	148	140	60	80	140
Fees & Licenses	-	-	-	-	-	-	4	2	2	4
Dues & Subscriptions	9	9	24	10	-	10	20	10	10	20
Materials & Supplies	25	20	22	14	3	17	22	11	11	22
Property Taxes	15	13	30	14	14	28	32	16	16	32
Education & Training	-	-	-	-	-	-	2	1	1	2
Special Projects	20	41	100	72	100	172	85	42	43	85
Utilities:										
Electricity	108	112	280	142	140	282	336	168	168	336
Janitorial	167	163	470	234	250	484	518	259	259	518
Natural Gas	15	18	32	27	15	42	42	21	21	42
Refuse Disposal	34	41	60	43	30	73	68	34	34	68
Water/Sewer/Stormwater/Streets	130	145	290	165	200	365	308	154	154	308
TOTAL MATERIALS & SERVICES	745	901	1,906	1,109	1,066	2,175	2,137	1,055	1,082	2,137
CAPITAL OUTLAY										
Vehicles & Equipment	-	-	-	-	-	-	65	-	65	65
Construction in Progress	194	142	2,115	501	460	961	1,350	1,245	105	1,350
TOTAL CAPITAL OUTLAY	194	142	2,115	501	460	961	1,415	1,245	170	1,415
FACILITIES MANAGEMENT TOTAL	\$ 1,325	\$ 1,484	\$ 4,901	\$ 2,038	\$ 1,938	\$ 3,976	\$ 4,497	\$ 2,767	\$ 1,730	\$ 4,497

EXPLANATION OF SIGNIFICANT BUDGET CHANGES

Facilities' materials and services budget increased by \$231,000 compared to prior biennium budget related to:

- 1) Increase of \$57,000 in Professional & Technical Services; includes general contractors and fire services.
- 2) Increase of \$56,000 or 20% and \$47,000 or 10% for electricity and janitorial services, respectively, associated with the increase of space for new city hall.
- 3) Increase of \$26,000 in dues and subscriptions for upgrade to facilities work order platform.
- 4) Increase of \$65,000 for replacement new facilities vehicle.
- 5) Increase of \$2,000 for education and training.
- 6) Increase of \$40,000 or 13% for landscape maintenance.

EXPLANATION OF SIGNIFICANT BUDGET CHANGES (CONTINUED)

- 7) Increase of \$8,000 or 13.3% for refuse services.
- 8) Increase of \$30,000 for HVAC services.
- 9) Decrease in \$10,000 or 16.67% in painting and plumbing services.
- 10) Increase in construction in progress as outlined in Capital Improvement Plan which includes continued efforts towards the seismic retrofits of the Public Safety Building (\$1.5 million-dollar total project amount); these expenses are partially offset by expected grant revenue of \$1,233,817. Removal of the Bertman House project is estimated at \$120,000. JCB Campus solar panel installation project is estimated at \$475,000; this expense is partially offset by the awarded Oregon Senate Bill 5506 General Fund Grant of \$350,000.



GENERAL FUND FINANCE

DEPARTMENT DESCRIPTION AND CORE SERVICES

Finance Department is an innovative leader and partner in fiscal stewardship and supports the community through collaboration, transparency, and strong financial management. Finance ensures the fiscal integrity of city operations while being good stewards of taxpayers' money and city-owned assets. Additionally, the Finance team strives to develop healthy partnerships with the community, be transparent with city finances, and look for cost efficiencies in all city operations. Below are processes the Finance team focuses on throughout the year:

- Administer utility billing, purchase cards, capital asset tracking, and business licensing
- Process payroll, accounts payable, and accounts receivable
- Banking and cash management
- Prepare financial and internal audits
- Manage 5-year forecast, budget process, and the on-going monitoring
- Oversee debt and investment management
- Minimize risk exposure and manage liability insurance and claims
- Manage franchise agreements
- Review citywide contracts and ensure compliance with public contracting laws
- Manage financial grant reconciliations and ensure compliance with state and federal regulations

ACCOMPLISHMENTS BN 2023-2024

- Received the Government Finance Officers Association national award for recognition in excellence for financial reporting and budgeting
- Ensured compliance with federal grant funding and requirements received from the American Rescue Plan Act and Coronavirus State Fiscal Recovery Fund
- Transitioned business licensing to a new software program
- Updated public contracting rules with revised equity-based requirements for increased competitive contract award opportunities to disadvantaged businesses
- Established lockbox payment processing with Umpqua Bank to reduce internal processing costs and provide customers with reliable continuity
- Launched new procurement software platform for formal and intermediate competitive solicitations
- Issued solicitation in partnership with Audit Committee and selected new firm for audit services

PRIORITIES BN 2025-2026



Review and document internal controls citywide to establish a strong internal audit environment and apply corrective actions where needed



Familiarize and onboard a new audit firm with internal controls and city processes



Streamline procurement processes through centralized tools and templates



Evaluate prospective budget software for modernizing the budget planning process



Update travel policy with clear guidelines that all employees can follow

PERFORMANCE MEASURES

Value	Metric	FY 2021	FY 2022	FY 2023	Estimated		
					FY 2024	FY 2025	FY 2026
Accountable	# of utility accounts maintained and managed	7,240	7,226	7,224	7,225	7,230	7,235
Accessible	# of utility bills processed and delivered	86,880	86,712	86,688	86,700	86,760	86,820
	# of business licenses issued	1,550	1,651	1,724	1,750	1,775	1,800
Efficient	# of funds managed	12	12	11	11	10	10
Accountable	# of adjusting journal entries processed	290	321	319	320	325	325
	# of accounts payable invoices processed	4,501	3,427	3,614	4,000	4,300	4,700
	# of payroll checks issued	3,620	3,942	3,904	3,950	3,950	3,950
Collaborative	# of city contracts reviewed and executed	109	110	111	125	135	145
	# of citywide grants received	4	4	9	8	6	6

FINANCIAL SUMMARY – FINANCE

(Amounts in Thousands: \$100 = \$100,000)

	HISTORICAL		BN 2023-2024 CURRENT OUTLOOK				BN 2025-2026			
	Actual FY 2021	Actual FY 2022	Amended Budget	Actual FY 2023	Estimated FY 2024	Estimated BN Total	Proposed Total	Approved FY 2025	Approved FY 2026	Approved Total
PERSONNEL SERVICES										
Budgeted FTE Positions	7.5	8.5	7.0	7.0	7.0	7.0	7.0	7.0	7.0	7.0
Salaries & Wages	\$ 629	\$ 663	\$ 1,259	\$ 602	\$ 656	\$ 1,258	\$ 1,352	666	686	\$ 1,352
Employee Benefits	347	372	765	304	339	643	781	386	395	781
TOTAL PERSONNEL SERVICES	\$ 976	\$ 1,035	\$ 2,024	\$ 906	\$ 995	\$ 1,901	\$ 2,133	\$ 1,052	\$ 1,081	\$ 2,133
MATERIALS & SERVICES										
Professional & Technical Services:										
Audit Services	51	49	160	79	85	164	170	85	85	170
Other	27	28	90	43	18	61	90	45	45	90
General Office Supplies	11	16	20	14	24	38	20	10	10	20
Fees & Licenses	4	5	34	6	6	12	20	10	10	20
Dues & Subscriptions	41	4	10	7	15	22	10	5	5	10
Education & Training	1	2	22	6	1	7	16	8	8	16
Bank Charges	174	192	420	223	240	463	420	210	210	420
Utility Billing Expense	95	98	240	103	101	204	250	125	125	250
TOTAL MATERIALS & SERVICES	404	394	996	481	490	971	996	498	498	996
FINANCE TOTAL	\$ 1,380	\$ 1,429	\$ 3,020	\$ 1,387	\$ 1,485	\$ 2,872	\$ 3,129	\$ 1,550	\$ 1,579	\$ 3,129

GENERAL FUND

FLEET SERVICES

DEPARTMENT DESCRIPTION AND CORE SERVICES

The Fleet Services Department recommends, purchases, and repairs city vehicles and equipment to ensure the health and safety of city residents and keep critical police and public works vehicles performing. The department performs continual analysis of the city's fleet to minimize monetary and environmental costs while providing effective, well-maintained vehicles.

Fleet Services maintains and repairs city vehicles, as well as a diverse inventory of equipment to maximize economic service life, ensure the lowest lifetime maintenance and repair, produce lower environmental costs, and minimize vehicle and equipment downtime by performing the following functions:

- Vehicle and equipment maintenance and repair, including areas in technical, specialty, motorized and heavy equipment
- Operate an organized, full-service shop providing timely repair and scheduled preventative maintenance for the city's fleet and Clackamas River Water's fleet, currently totaling 121 vehicles and 214 pieces of equipment
- Oversee specialty repairs and maintenance for bodywork, electrical, and software-related matters
- Organize and analyze usage data to facilitate purchasing new vehicles, software, and equipment
- Surplus and dispose of vehicles and equipment no longer needed to perform city services

ACCOMPLISHMENTS BN 2023-2024

- Continued providing in-house services to modify and upfit two police vehicles with required equipment
- Researched and evaluated specifications for larger equipment such as vacuators and sweepers
- Provided aggressive turn-around times for urgent repairs on police and public works vehicles
- Continued efforts using R99 renewable diesel
- Purchased seven vehicles for the city fleet and disposed of two vehicles and seven pieces of varied equipment at auction

PRIORITIES BN 2025-2026



Continue to maximize upfitting of police and public works vehicles by performing services to reduce costs and service times



Continue to increase electric vehicle (EV) replacements and EV miles travelled by promoting and proposing options to departments



Enter into a fuel service contract for city fleet and equipment



Maintain Fleet Eco-Biz Certification by Pollution Prevention Outreach Team of Portland

PERFORMANCE MEASURES

Value	Metric	FY 2021	FY 2022	FY 2023	Estimated		
					FY 2024	FY 2025	FY 2026
Accountable	# of fleet work orders	462	417	370	400	400	400
	\$ revenue received from Clackamas River Water for city-provided vehicle maintenance	\$11,000	\$16,192	\$18,626	\$17,000	\$17,000	\$17,000
	# of equipment pieces maintained (including radios)	200	208	214	220	220	220
	# of vehicles maintained	145	122	121	129	136	142
Efficient	# of diesel miles	15,000	21,237	14,794	18,000	18,000	18,000
	# of hybrid miles used	13,600	7,278	8,054	8,000	8,000	8,000
	# of electric miles used	4,480	6,880	7,348	7,000	7,000	7,000
	# of PHEV miles used	6,250	14,728	11,260	13,000	13,000	13,000
	# of combined hybrid and electric miles	24,330	28,886	26,662	28,000	28,000	28,000

FINANCIAL SUMMARY – FLEET SERVICES

(Amounts in Thousands: \$100 = \$100,000)

	HISTORICAL		BN 2023-2024 CURRENT OUTLOOK				BN 2025-2026			
	Actual FY 2021	Actual FY 2022	Amended Budget	Actual FY 2023	Estimated FY 2024	Estimated BN Total	Proposed Total	Approved FY 2025	Approved FY 2026	Approved Total
PERSONNEL SERVICES										
Budgeted FTE Positions	3.0	3.0	3.0	3.0	3.0	3.0	3.0	3.0	3.0	3.0
Salaries & Wages	\$ 186	\$ 211	\$ 459	\$ 224	\$ 211	\$ 435	\$ 475	\$ 234	\$ 241	\$ 475
Employee Benefits	103	113	275	125	111	236	234	116	118	234
TOTAL PERSONNEL SERVICES	\$ 289	\$ 324	\$ 734	\$ 349	\$ 322	\$ 671	\$ 709	\$ 350	\$ 359	\$ 709
MATERIALS & SERVICES										
Professional & Technical Services	5	5	20	6	7	13	20	10	10	20
General Office Supplies	-	3	2	1	1	2	2	1	1	2
Fees & Licenses	2	2	4	2	4	6	5	3	2	5
Dues & Subscriptions	2	2	8	2	2	4	6	3	3	6
Materials & Supplies	7	16	20	12	8	20	20	10	10	20
Education & Training	-	2	6	3	2	5	6	3	3	6
Repairs, Fuel & Parts:										
Fuel & Oil Purchases	108	169	300	159	140	299	324	162	162	324
Repair Supplies	114	9	240	101	100	201	210	105	105	210
Repair & Maintenance	1	126	20	-	32	32	32	12	20	32
Tire Purchases	22	23	40	12	18	30	40	20	20	40
TOTAL MATERIALS & SERVICES	261	357	660	298	314	612	665	329	336	665
Capital Outlay										
Vehicles & Equipment	-	-	60	-	62	62	12	-	12	12
TOTAL CAPITAL OUTLAY	-	-	60	-	62	62	12	-	12	12
Fleet Services Total	\$ 550	\$ 681	\$ 1,454	\$ 647	\$ 698	\$ 1,345	\$ 1,386	\$ 679	\$ 707	\$ 1,386

GENERAL FUND

HUMAN RESOURCES

DEPARTMENT DESCRIPTION AND CORE SERVICES

The Human Resources Department attracts, develops, and retains a productive, diverse workforce dedicated to providing quality services to the Milwaukie community. The department provides a full range of comprehensive human resource services and programs to the city, such as:

- Recruit and retain a skilled, diverse, and service-oriented workforce
- Foster a cooperative labor-management relationship with represented employees
- Ensure legal compliance of the city with respect to human resources management
- Develop, implement, interpret, and maintain human resource policies, procedures, and collective bargaining agreements
- Maintain an employee coaching process
- Ensure employees have comprehensive, affordable, and competitive benefits that are effectively administered and communicated
- Coach managers on overseeing employee performance, disciplinary procedures, and conflict resolution
- Manage employee classification and compensation systems
- Implement and maintain employee recognition, wellness, and safety programs
- Provide training and development opportunities to managers and employees

ACCOMPLISHMENTS BN 2023-2024

- Implemented, evaluated, and refined software solution for onboarding new hires
- Procured and implemented learning management software to improve consistency and access to training modules for all employees
- Reviewed and revised nearly 70% of personnel policies to ensure legal compliance and implement best practices across a variety of topics
- Applied electronic filing system and transitioned personnel files to digital format
- Administered a formal solicitation to contract for employment-related and labor representation support services

PRIORITIES BN 2025-2026



Develop bench strength within the department to ensure seamless support for the organization during times of transition and workload shifts



Continue to promote diversity, equity, and inclusion in the employee and applicant experience



Enhance the safety program to ensure compliance and deliver job-appropriate training to employees



Develop and implement employee engagement strategies in partnership with department managers and employee groups

CHANGES TO SERVICE

Human Resources plans a renewed focus on staff safety and wellness in the coming biennium.

PERFORMANCE MEASURES

Value	Metric	FY 2021	FY 2022	FY 2023	Estimated		
					FY 2024	FY 2025	FY 2026
Accessible	# of employment applications received	1,075	960	701	900	900	900
Efficient	# of recruitments processed	28	35	30	28	28	28
	# of new hires	8	31	20	20	20	20
Accountable	# of labor contracts negotiated	2	0	0	2	0	1
	% of regular status employees who successfully completed the first 180 days of employment	100%	100%	100%	100%	100%	100%
	% of turnover citywide	13.5%	12.3%	12.3%	12%	12%	12%
	% of turnover for retirees	0%	2%	0%	2%	2%	2%
	% of turnover for new jobs outside of Milwaukie	8.1%	5%	8%	7%	7%	7%
	% of turnover for cause, education, relocation, health or other personal reasons	2%	6%	4%	3%	3%	3%

FINANCIAL SUMMARY – HUMAN RESOURCES

	HISTORICAL		BN 2023-2024 CURRENT OUTLOOK				BN 2025-2026			
	Actual FY 2021	Actual FY 2022	Amended Budget	Actual FY 2023	Estimated FY 2024	Estimated BN Total	Proposed Total	Approved FY 2025	Approved FY 2026	Approved Total
<i>(Amounts in Thousands: \$100 = \$100,000)</i>										
PERSONNEL SERVICES										
Budgeted FTE Positions	2.0	2.0	2.0	2.0	2.0	2.0	2.0	2.0	2.0	2.0
Salaries & Wages	\$ 199	\$ 249	\$ 441	\$ 207	\$ 201	\$ 408	\$ 475	\$ 234	\$ 241	\$ 475
Employee Benefits	99	105	269	123	116	239	359	178	181	359
TOTAL PERSONNEL SERVICES	\$ 298	\$ 354	\$ 710	\$ 330	\$ 317	\$ 647	\$ 834	\$ 412	\$ 422	\$ 834
MATERIALS & SERVICES										
Professional & Technical Services:										
City Attorney - Labor	30	1	16	57	2	59	20	10	10	20
Negotiation Services	16	17	30	5	25	30	20	10	10	20
Other	25	44	72	35	40	75	94	51	43	94
General Office Supplies	-	1	4	2	2	4	4	2	2	4
Dues & Subscriptions	-	3	2	-	2	2	2	1	1	2
Education & Training	-	1	4	5	1	6	4	2	2	4
Advertising & Publicity	4	9	10	6	6	12	6	3	3	6
Employee Recognition & Trainings	-	3	48	10	13	23	36	18	18	36
Wellness Program	-	-	4	-	-	-	4	2	2	4
TOTAL MATERIALS & SERVICES	75	79	190	120	91	211	190	99	91	190
HUMAN RESOURCES TOTAL	\$ 373	\$ 433	\$ 900	\$ 450	\$ 408	\$ 858	\$ 1,024	\$ 511	\$ 513	\$ 1,024

GENERAL FUND

INFORMATION TECHNOLOGY

DEPARTMENT DESCRIPTION AND CORE SERVICES

Information Technology (IT) is part of the Finance Department and provides a strategic technology vision promoting security, availability and reliability for city operations and the community. IT provides impactful, efficient, and secure management of the city's information and communications technologies.





The department manages the city's data, improves business processes, implements technology projects and systems, and drives innovation and transformation in Milwaukie's operations through experimentation, training, and culture change. IT accomplishes this work through:

- Research, procurement, implementation, and maintenance of the city's enterprise network, telephony systems, computer hardware and software systems to support employees and city operations
- Provide training to city employees on selected software applications
- Consult and strategize with departments to solve technology challenges
- Administer and maintain software and hardware on all server, desktop, and laptop/mobile platforms
- Efficiently place and dispose of surplus hardware and software assets
- Provide ongoing maintenance for the city's telephony systems, including the VoIP hardware/software and all desk phones, voice circuits, data circuits, VPNs, firewalls, remote access, and mobile devices
- Deliver customer service support (primarily to internal customers) through a centralized helpdesk system, and engage with city employees and vendors to resolve issues timely based on priority and urgency
- Assist in specification and implementation of end-user requirements for mission-critical applications, including communication with department managers to identify qualified vendors and feasible alternative solutions
- Identify, strategize, and coordinate technology needs to determine whether current software applications can meet future needs

ACCOMPLISHMENTS BN 2023-2024

- Upgraded network servers to Windows 2019 or newer
- Replaced wireless access points and datacenter/network switches citywide
- Re-established in-house customer support and reduced response time for ticket resolution
- Created a new, reliable IT network at new city hall, including fiber connection, security system, and robust technology for internal and public meetings
- Completed deployment of multi-factor authentication across the organization
- Performed trainings and monthly phishing exercises to increase cybersecurity awareness
- Migrated to new mobile device management platform that utilized existing licensing to reduce costs
- Successfully completed an audit process conducted by the Criminal Justice Information Services audit unit for the protection and safeguard of the city's criminal justice information

PRIORITIES BN 2025-2026

-  Facilitate training for city employees on software applications and utilize available tools to their full potential
-  Maintain citywide operations with a high level of customer service and low response times
-  Implement new Supervisory Control and Data Acquisition network and applications for public works operations
-  Upgrade all desktops and laptops to Windows 11
-  Patch software vulnerabilities as they occur to maintain a secure cyber infrastructure

PERFORMANCE MEASURES

Value	Metric	FY 2021	FY 2022	FY 2023	Estimated		
					FY 2024	FY 2025	FY 2026
Accessible	# of service requests submitted to help desk	881	250	1,420	2,100	2,100	2,100
Efficient	# of days for help desk resolution (average)	3	4	2	1	1	1
Accountable	% of cybersecurity trainings for staff (average)	92%	95%	99%	100%	100%	100%
	% of quarterly phishing test failures of staff	14.5%	13.3%	9.4%	7%	6%	6%



FINANCIAL SUMMARY – INFORMATION TECHNOLOGY

(Amounts in Thousands: \$100 = \$100,000)

	HISTORICAL		BN 2023-2024 CURRENT OUTLOOK				BN 2025-2026			
	Actual FY 2021	Actual FY 2022	Amended Budget	Actual FY 2023	Estimated FY 2024	Estimated BN Total	Proposed Total	Approved FY 2025	Approved FY 2026	Approved Total
PERSONNEL SERVICES										
Budgeted FTE Positions	3.0	3.0	3.0	3.0	3.0	3.0	3.0	3.0	3.0	3.0
Salaries & Wages	\$ 301	\$ 297	\$ 663	\$ 252	\$ 280	\$ 532	\$ 610	\$ 301	\$ 309	\$ 610
Employee Benefits	132	128	324	125	147	272	328	162	166	328
TOTAL PERSONNEL SERVICES	433	425	987	377	427	804	938	463	475	938
MATERIALS & SERVICES										
Professional & Technical Services:										
Maintenance Agreements	508	589	1,147	415	755	1,170	1,414	685	729	1,414
Telephone	106	121	272	122	114	236	384	184	200	384
Rents & Leases	37	41	76	15	24	39	64	32	32	64
Other	36	155	290	77	12	89	54	22	32	54
General Office Supplies	15	26	60	21	12	33	42	21	21	42
Education & Training	6	2	10	1	2	3	10	5	5	10
Computer Hardware	64	88	100	86	114	200	154	77	77	154
TOTAL MATERIALS & SERVICES	772	1,022	1,955	737	1,033	1,770	2,122	1,026	1,096	2,122
CAPITAL OUTLAY										
Furniture & Equipment	83	67	157	196	256	452	215	180	35	215
TOTAL CAPITAL OUTLAY	83	67	157	196	256	452	215	180	35	215
INFORMATION TECHNOLOGY TOTAL	\$ 1,288	\$ 1,514	\$ 3,099	\$ 1,310	\$ 1,716	\$ 3,026	\$ 3,275	\$ 1,669	\$ 1,606	\$ 3,275



RS234

GENERAL FUND

MUNICIPAL COURT

DEPARTMENT DESCRIPTION AND CORE SERVICES

Municipal Court serves as the judicial branch of the city government. Its mission is to provide a fair and impartial local forum for the resolution of traffic violations, parking citations, minors in possession of tobacco, and breaches to the municipal code.

The department responds to questions about municipal court processes and procedures, the fee schedule and presumptive fine amounts, and other administrative matters. Municipal Court administers judicial proceedings and docketing, and coordinates court matters with defendants, the appointed judge, city prosecutor, finance department, code enforcement department, police department, and other local and state justice agencies.

Most incorporated cities, like Milwaukie, have a municipal court as authorized by state law with jurisdiction over city ordinance and traffic violations, defined by Oregon state law, occurring within the city limits. The city does not have a misdemeanor court and by statute has no jurisdiction over felonies. Milwaukie is situated on two major highways, where the Milwaukie Police Department enforces traffic violations to protect community livability and to reduce incidences of vehicular-involved accidents.

ACCOMPLISHMENTS BN 2023-2024

- Continued transition to a paperless court by reviewing and disposing of old records, shifting internal processes to digital actions, and working with the city recorder's office to prepare for the move to new city hall
- Implemented and administered two limited-duration court fine amnesty programs
- Participated in the relocation to new city hall and ensured the new chambers room included modernized court facilities to manage current and future court needs
- Partnered with LoveOne and The Father's Heart Street Ministry to provide court dockets to each organization to support their participants in appearing in court
- Implemented new security procedures on court days to create a safer environment for employees, defendants, and visitors of city hall

PRIORITIES BN 2025-2026



Prepare for increased citations and court activity due to implementation of body worn cameras, increased patrols by the Police Department, additional staffing in the Code Enforcement Department, and transition to a new electronic ticketing system



Continue to enhance court support services by providing monthly Spanish language interpreter services



Explore opportunities to develop court operations that support community needs, including creation of more electronic processes



Continue to evaluate and modify security protocols during court days to provide a safe and secure environment for employees and guests of city hall

CHANGES TO SERVICE

- During fiscal years 2022 and 2023, Municipal Court decided not to report driver license suspensions to the Oregon Department of Motor Vehicles (DMV) because of the COVID-19 pandemic and a simultaneous decrease in court staffing levels. The reduction in staffing levels proved to be difficult in continuing to process and report suspended licenses. Despite no changes to staffing levels, the department will work to resume reporting suspended licenses to DMV in the upcoming biennium.
- In response to the cultural environment the Municipal Court operates in, and as a result of a security incident that occurred in late 2023, staff will continue to evaluate the number of security officers present at city hall on court days and the effectiveness of current security protocols. The 2025-2026 department budget accounts for the increased costs of security services.

PERFORMANCE MEASURES

Value	Metric	FY 2021	FY 2022	FY 2023	Estimated		
					FY 2024	FY 2025	FY 2026
Accountable	# of traffic citations processed	1,566	1,122	1,814	2,300	2,500	2,600
	# of parking citations processed	2,000	1,515	1,500	1,700	1,800	1,800
	# of code citations processed	60	52	78	80	90	95
	# of drivers licenses suspended for failure to pay fines	960	0	0	0	1,246	1,150
Efficient	# of cases disposed of within 90 days of issuance	1,870	1,715	2,165	2,572	3,000	3,300
	\$ amount of operating cost per processed violation	\$37	\$35	\$37	\$39	\$39	\$40

FINANCIAL SUMMARY – MUNICIPAL COURT

	HISTORICAL		BN 2023-2024 CURRENT OUTLOOK				BN 2025-2026			
	Actual FY 2021	Actual FY 2022	Amended Budget	Actual FY 2023	Estimated FY 2024	Estimated BN Total	Proposed Total	Approved FY 2025	Approved FY 2026	Approved Total
<i>(Amounts in Thousands: \$100 = \$100,000)</i>										
PERSONNEL SERVICES										
Budgeted FTE Positions	1.5	0.5	0.5	0.5	0.5	0.5	1.0	1.0	1.0	1.0
Salaries & Wages	\$ 126	\$ 34	\$ 73	\$ 35	\$ 40	\$ 75	\$ 146	\$ 72	\$ 74	\$ 146
Employee Benefits	64	23	48	22	24	46	95	47	48	95
TOTAL PERSONNEL SERVICES	\$ 190	\$ 57	\$ 121	\$ 57	\$ 64	\$ 121	\$ 241	\$ 119	\$ 122	\$ 241
MATERIALS & SERVICES										
Professional and Technical Services:										
Judge	21	22	56	30	32	62	60	30	30	60
Prosecutor	27	37	77	34	32	66	78	39	39	78
Other	2	5	18	-	-	-	24	12	12	24
General Office Supplies	2	2	2	-	-	-	-	-	-	-
Dues & Subscriptions	-	-	2	-	-	-	2	1	1	2
Education & Training	-	1	3	2	2	4	2	1	1	2
TOTAL MATERIALS & SERVICES	52	67	158	66	66	132	166	83	83	166
MUNICIPAL COURT TOTAL	\$ 242	\$ 124	\$ 279	\$ 123	\$ 130	\$ 253	\$ 407	\$ 202	\$ 205	\$ 407

GENERAL FUND

PLANNING SERVICES

DEPARTMENT DESCRIPTION AND CORE SERVICES

The Planning Department collaborates with community and colleagues to advance the vision of Milwaukie as a livable city. This is done by providing timely, reliable information and assistance to customers; facilitating and coordinating projects and discussions to achieve community solutions and completion of projects; and promoting safety, livability and vitality through high quality development review and long-range planning services.

The Planning Department balances projects that fall into four distinct categories: 1) fulfill the city's development review responsibilities; 2) develop and implement large and small code and policy changes; 3) manage and complete long-range planning projects; and 4) support the Community Development Department in developing and implementing projects to enhance the community. The department's core services include:

- Administer zoning, sign and land division ordinances, and state and federal laws regulating development within the city
- Support for Council, Planning Commission and other council-appointed committees in achieving the community's vision and comprehensive plans
- Complete projects required to comply with the Metro Urban Growth Management Functional Plan and Regional Transportation Plan
- Complete projects required to comply with Oregon Department of Land Conservation and Development (DLCD) rulemaking and state land use requirements
- Assist applicants and educate the public in understanding and following the city's regulations and development process
- Support the Community Development Department in economic development, community enhancement, and capital improvement projects
- Promote livability and protect property and natural resources by complying with city regulations

ACCOMPLISHMENTS BN 2023-2024

- Adopted a housing capacity analysis to assess future demand for housing units across a range of prices, rent levels, and housing types
- Produced a corresponding housing production strategy to identify strategies and actions to meet the housing demand and facilitate production
- Completed updates to the Downtown Design Guidelines and Standards to clarify and simplify the downtown review process
- Kicked-off the development of an overhauled Transportation System Plan, including assessment of how to reduce vehicle miles traveled and greenhouse gas emissions and how to remove barriers to transportation options for all users
- Collaborated with Community Development Department to develop the second phase of neighborhood hubs to provide opportunity for gathering places and locations where residents have access to a variety of services or goods within walking or biking distance of their homes, thus reducing the number of trips required by vehicles.
- Partnered with Building Department to implement requirements of House Bill 2180 requiring construction of certain buildings to provide for electrical vehicle charging for a percentage of parking spaces

ACCOMPLISHMENTS BN 2023-2024 (CONTINUED)

- Consolidated the city's high density residential zones from five zones to one and revised definitions and terminology for allowed residential uses
- Managed a steady flow of land use applications, including Balfour and Bowman-Brae Park plans and modifications to historic city hall, as well as several pre-application conferences for middle housing developments
- Updated Milwaukie Municipal Code for Title 17 (Land Division) and a number of housekeeping code amendments to reflect state law, include clear and objective standards, clarify language and authority, and address middle housing
- Updated Milwaukie Municipal Code to reflect the Oregon Psilocybin Service Act which allows for the manufacture, delivery, and administration of psilocybin at licensed facilities
- Implemented necessary code amendments required by Governor Brown's Executive Order 20-04 directing state agencies to reduce climate pollution through the DLCDC's Climate-Friendly and Equitable Communities Rulemaking

PRIORITIES BN 2025-2026



Adopt the Transportation System Plan that addresses the needs of all users with an emphasis on underrepresented community members, and includes strategies to reduce vehicle miles traveled and greenhouse gas emissions



Update natural resources code to make it easier for applicants and staff to navigate and develop clear and objective standards for residential projects, streamline with tree code, establish a more accurate methodology for verification of Habitat Conservation Areas, and other code clarifications



Potentially develop the third phase of the Neighborhood Hubs program, including potential boundary adjustments, development of small area plans, and exploring the potential for allowing accessory commercial units



Evaluate Community Service Use code to assess which uses are applicable and deem how they are evaluated, with a particular focus on parks, institutions, and churches



Implement code amendments required by the Governor Executive Orders as necessary



Explore establishing two tiers of Willamette Greenway review and develop clear and objective standards for residential development



Develop new affordable housing incentives via code amendments, evaluate increasing densities in the Residential High-Capacity zone, and adopt pre-approved plan sets for accessory dwelling units and middle housing typologies – all as identified in the state-required Housing Production Strategy



Develop a new Town Center Plan to replace the outdated 1997 plan and consolidate the Downtown/Riverfront Plan



Update the Historic Resources inventory and corresponding code, as needed



Follow the Federal Emergency Management Agency and State of Oregon's work regarding floodplain management and update the code, if applicable

PERFORMANCE MEASURES

Value	Metric	FY 2021	FY 2022	FY 2023	Estimated		
					FY 2024	FY 2025	FY 2026
Accessible	# of open houses, workshops and public involvement meetings/presentations	31	2	25	20	20	20
	# of annexations	5	2	5	8	8	8
Efficient	# of Type I land use applications submitted	19	27	21	20	20	20
	# of Type II land use applications submitted	21	9	18	15	15	15
	# of Type III land use applications submitted	21	11	11	12	12	12
	# of Type IV land use applications submitted	2	0	0	1	1	1
	# of Type V land use applications submitted	3	3	7	4	4	4
Accountable	# of Type III/IV/V land use hearings	21	37	26	20	20	20
	# of pre-application meeting/conference	23	30	27	20	20	20

FINANCIAL SUMMARY – PLANNING SERVICES

(Amounts in Thousands: \$100 = \$100,000)

	HISTORICAL		BN 2023-2024 CURRENT OUTLOOK				BN 2025-2026			
	Actual FY 2021	Actual FY 2022	Amended Budget	Actual FY 2023	Estimated FY 2024	Estimated BN Total	Proposed Total	Approved FY 2025	Approved FY 2026	Approved Total
PERSONNEL SERVICES										
Budgeted FTE Positions	5.0	5.0	5.0	5.0	5.0	5.0	5.0	5.0	5.0	5.0
Salaries & Wages	\$ 425	\$ 434	\$ 1,014	\$ 476	\$ 503	\$ 979	\$ 1,056	520	536	\$ 1,056
Employee Benefits	193	205	511	237	250	487	551	272	279	551
TOTAL PERSONNEL SERVICES	\$ 618	\$ 639	\$ 1,525	\$ 713	\$ 753	\$ 1,466	\$ 1,607	\$ 792	\$ 815	\$ 1,607
MATERIALS & SERVICES										
Professional & Technical Services	199	92	341	119	62	181	195	60	135	195
General Office Supplies	-	-	1	2	1	3	2	1	1	2
Dues & Subscriptions	2	2	6	1	2	3	8	4	4	8
Education & Training	1	1	14	3	3	6	14	7	7	14
Assisted Annexation	-	1	4	1	1	2	5	2	3	5
Miscellaneous	1	1	14	1	1	2	6	3	3	6
TOTAL MATERIALS & SERVICES	203	97	380	127	70	197	230	77	153	230
PLANNING TOTAL	\$ 821	\$ 736	\$ 1,905	\$ 840	\$ 823	\$ 1,663	\$ 1,837	\$ 869	\$ 968	\$ 1,837



RS240

GENERAL FUND

CODE ENFORCEMENT

DEPARTMENT DESCRIPTION AND CORE SERVICES

Code Enforcement achieves neighborhood preservation, code compliance, and nuisance abatement by facilitating interagency coordination to solve livability problems within the city and along its borders.

The Code Enforcement Department is responsible for managing code compliance cases for the entire city and parking enforcement in the downtown area. This work is accomplished through:

- Public education on codes and nuisances
- Emphasizing voluntary compliance before enforcement
- Conflict resolution
- Resource referral and abatement

ACCOMPLISHMENTS BN 2023-2024

- Implemented a new online complaint form for code violation reporting
- Updated fireworks ordinance to include a ban on consumer fireworks
- Implemented a new fireworks enforcement program, which includes working at night during fireworks season and issuing citations and notices regarding fireworks usage
- Instituted a tall grass and weeds enforcement strategy to try and prevent fire danger related to hot weather and illegal firework usage
- Developed and implemented an enforcement strategy for the residential tree protection ordinance
- Revised the city's Tree Code into a more readable and enforceable code
- Developed a new "Welcome to Milwaukie" brochure for residential and downtown businesses
- Developed a new camping ordinance and enforcement procedures
- Executed a contract for abandoned recreational vehicles and related disposal services
- Received two grants from Metro totaling \$10,000 for disposal of abandoned recreational vehicles

PRIORITIES BN 2025-2026



Achieve a 90% case resolution rate for all code cases prior to citation issuance through investigative site visits and communication with property owner



Reduce the number of outstanding cases by conducting abatements



Finalize lien foreclosure policies and procedures with finance and city manager departments



Increase public education efforts by reinstating a "Welcome to Milwaukie" brochure dispersal program

PERFORMANCE MEASURES

Value	Metric	FY 2021	FY 2022	FY 2023	Estimated		
					FY 2024	FY 2025	FY 2026
Efficient	# of parking citations issued (may include multiple violations)	1,549	1,268	1,219	1,200	1,200	1,200
	# of code citations issued (may include multiple violations)	51	73	94	100	100	100
	% of cases generated where no violation exists	30%	18%	11%	9%	9%	9%
	% of compliance after notice(s)	64%	77%	84%	82%	82%	82%
	% of compliance after citation	6%	5%	5%	8%	8%	8%
	# of properties in compliance after abatement notice posted	0	0	0	3	3	3
Accountable	# of properties cleaned by the city	0	0	0	1	3	3
	# of code cases generated by department staff	130	544	484	475	475	475
Accessible	# of code cases generated by community	290	282	401	300	300	300
Collaborative	# of code cases generated by other city staff	180	374	375	375	375	375

FINANCIAL SUMMARY – CODE ENFORCEMENT

(Amounts in Thousands: \$100 = \$100,000)

	HISTORICAL		BN 2023-2024 CURRENT OUTLOOK				BN 2025-2026				Notes
	Actual FY 2021	Actual FY 2022	Amended Budget	Actual FY 2023	Estimated FY 2024	Estimated BN Total	Proposed Total	Approved FY 2025	Approved FY 2026	Approved Total	
PERSONNEL SERVICES											
Budgeted FTE Positions	2.0	3.0	3.0	3.0	3.0	3.0	3.0	3.0	3.0	3.0	
Salaries & Wages	\$ 119	\$ 151	\$ 381	\$ 194	\$ 208	\$ 402	\$ 442	\$ 218	\$ 224	\$ 442	
Employee Benefits	80	93	244	119	125	244	277	137	140	277	
TOTAL PERSONNEL SERVICES	\$ 199	\$ 244	\$ 625	\$ 313	\$ 333	\$ 646	\$ 719	\$ 355	\$ 364	\$ 719	
MATERIALS & SERVICES											
Professional & Technical Services	6	6	38	18	17	35	70	35	35	70	
General Office Supplies	4	6	14	6	6	12	14	7	7	14	
Dues & Subscriptions	-	-	-	-	1	1	2	1	1	2	
Education & Training	1	1	6	1	4	5	6	3	3	6	
Abatement	-	-	30	1	1	2	30	15	15	30	
TOTAL MATERIALS & SERVICES	11	13	88	26	29	55	122	61	61	122	
CODE ENFORCEMENT TOTAL	\$ 210	\$ 257	\$ 713	\$ 339	\$ 362	\$ 701	\$ 841	\$ 416	\$ 425	\$ 841	

¹ Increase is to pay for RV Removal program, Revenues offset with Metro Grant.

GENERAL FUND

PUBLIC, EDUCATIONAL, GOVERNMENT (PEG)

DEPARTMENT DESCRIPTION AND CORE SERVICES

The Public, Educational and Government (PEG) Department serves the public interest by administering funds to support access centers. It is committed to enriching the lives of city residents by communicating information over public, educational and government access television channels, which provide a venue for residents, schools, and city government. Through a franchise agreement with Comcast, these channels are provided to every cable subscriber.

PEG supports one government access center, two educational access centers (Clackamas Community College and Sabin-Schellenberg Professional Technical Center), and one public access studio (Willamette Falls Studios).

PEG funds are assessed on the wireline cable providers supplying service to the residents of Milwaukie. The city collects these funds and allocates them to the PEG access centers. PEG funds are restricted and can only be used to support the capital facilities and equipment for the access centers. Through a franchise agreement there are six PEG channels available to all cable subscribers in Milwaukie. The Milwaukie Government channel is carried by Comcast on channel 30, while other channels are CAN channel 11, Milwaukie Public Access channel 23, Clackamas Community College channel 27, North Clackamas School District channel 28, and the Clackamas County Government channel 30.

ACCOMPLISHMENTS BN 2023-2024

Supported the move to new city hall by funding a new Council Chambers meeting room with new audio and visual equipment and a multi-purpose dais.

PRIORITIES BN 2025-2026



Continue to support and fund equipment needed to provide quality cable content.

PERFORMANCE MEASURES

Value	Metric	FY 2021	FY 2022	FY 2023	Estimated		
					FY 2024	FY 2025	FY 2026
Accessible	# of programs with original non-repetitive productions produced for public access cablecast	31	45	46	50	55	60
	# of hours of public access programming	24	99	220	225	230	235
	# of city government televised meetings	72	75	69	60	60	60

FINANCIAL SUMMARY – PUBLIC, EDUCATIONAL, GOVERNMENT

(Amounts in Thousands: \$100 = \$100,000)

	HISTORICAL		BN 2023-2024 CURRENT OUTLOOK				BN 2025-2026			
	Actual FY 2021	Actual FY 2022	Amended Budget	Actual FY 2023	Estimated FY 2024	Estimated BN Total	Proposed Total	Approved FY 2025	Approved FY 2026	Approved Total
MATERIALS & SERVICES										
Equipment <\$10,000	\$ -	\$ 14	\$ -	\$ 1	\$ 12	\$ 13	\$ 10	\$ 5	\$ 5	\$ 10
Education & Local TV Grants	5	-	35	-	-	-	25	13	13	25
TOTAL MATERIALS & SERVICES	5	14	35	1	12	13	35	18	18	35
CAPITAL OUTLAY										
Equipment	-	-	171	136	100	236	-	-	-	-
TOTAL CAPITAL OUTLAY	-	-	171	136	100	236	-	-	-	-
PEG Total	\$ 5	\$ 14	\$ 206	\$ 137	\$ 112	\$ 249	\$ 35	\$ 18	\$ 18	\$ 35



GENERAL FUND CITY RECORDER

DEPARTMENT DESCRIPTION AND CORE SERVICES

The City Recorder supports City Council, administers the city's records management program, coordinates city elections, and is the front-facing support for most of the city's services. The department is responsible for ensuring that all public meeting and records laws are enforced, providing support to the city administration through in-person and phone interactions with the public, and working with community partners to promote Milwaukie's heritage. A primary objective of the city recorder's office in its capacity as the city hall administrative team is to help foster collaboration of city departments for the efficient delivery of services to the public.

As clerk of the Council, the City Recorder supports and records all Council proceedings and manages all public records. The department is charged with agenda preparation, ordinance and resolution maintenance, preparation of official meetings and legal notices, and processing of official documents and minutes. Additionally, the City Recorder oversees the city's electronic records management system, supports the city's boards and committees, and serves as the city's elections officer. The department achieves these core services by providing:

- Administrative support for Council, advisory boards, and constituents by maintaining access to information as it relates to the legislative process
- Administrative and reception support for city hall, including the city manager's office, engineering, finance, planning, building, and community development departments
- Support for Oregon's open decision-making policies and statutes through publication and distribution of meeting times and locations, relevant documentation, and preparation and maintenance of agendas, minutes and supporting documentation
- Oversight of regular standing board and committee recruitment and appointment processes
- Administration of the city's records management program by meeting operational goals and making information readily available through technology and best practices
- Engagement with community partners to promote Milwaukie's heritage by collaborating on special events and making historic documents publicly available
- Administration of municipal elections by verifying filing materials, preparing and submitting proposed ballot titles, providing forms and information to the public, publishing election notices, and certifying results



ACCOMPLISHMENTS BN 2023-2024

- Supported Council and employees in the move to new city hall by organizing a new records room and arranging a staff celebration at the new building
- Purged twice the average number of paper files meeting retention in a fiscal year in preparation for the move to new city hall
- Expanded staffing support for new city hall front office to better assist the community with questions and taking payments for business registrations, building permits, court, engineering, planning, and utility billing
- Administered city election responsibilities for the November 2022 election
- Administered annual recruitment and interview processes for city boards and committees, which included a record number of appointments in fiscal year 2023 due to the establishment of several new advisory and ad hoc committees
- Built and strengthened community relationships with the Milwaukie Historical Society, American Legion Post 180, Susannah Lee Barlow Chapter of the Daughters of the American Revolution, and Confederated Tribes of the Grand Ronde
- Provided electronic records management training for new and existing employees
- Centralized office supply purchasing for all city hall departments to avoid duplicate purchases, reduce number of deliveries, and increase discounts for bulk purchases

PRIORITIES BN 2025-2026



Continue administrative support to City Council and administration



Administer 2024 City Council elections that ensures all candidates are given equal access to the information necessary to run for public office



Make sure public meetings follow state regulations and city policy



Build and grow community partner relationships by engaging with local and regional partners to plan events, coordinate projects, and continue discussions



Increase records training by providing department-specific electronic record management trainings

CHANGES TO SERVICE

- Continue to expand its role in coordinating the delivery of front-facing services provided by the community development and finance departments
- Continue to streamline the boards and committees' recruitment process, looking to increase participation by youth community members while making the application and interview process as accessible and equitable as possible

PERFORMANCE MEASURES

Value	Metric	FY 2021	FY 2022	FY 2023	Estimated		
					FY 2024	FY 2025	FY 2026
Accountable	# of record requests	370	380	376	380	385	390
	# elections for City Council or ballot measures	1	0	1	0	1	0
Accessible	# of video views for City Council meetings (YouTube)	3,129	4,476	5,636	5,500	6,000	6,500
	# of video views for cultural events (YouTube)	3,111	557	455	540	600	650
	# of digital records filed in records management system	6,754	6,206	104,518	10,000	8,500	8,500
Efficient	# of digital records purged from records management system	2,611	0	9,737	10,000	7,500	7,500
	# in cubic feet of paper files purged citywide	36	45	83	40	40	40
	# of payments processed at front counter	34,207	30,980	28,191	17,796	2,500	2,500
Collaborative	# of members appointed (new or renewed) on boards and committees	45	48	64	40	40	40
	# of electronic record management trainings provided	n/a	6	15	20	10	10

FINANCIAL SUMMARY – CITY RECORDER

(Amounts in Thousands: \$100 = \$100,000)

	HISTORICAL		BN 2023-2024 CURRENT OUTLOOK				BN 2025-2026			
	Actual FY 2021	Actual FY 2022	Amended Budget	Actual FY 2023	Estimated FY 2024	Estimated BN Total	Proposed Total	Approved FY 2025	Approved FY 2026	Approved Total
PERSONNEL SERVICES										
Budgeted FTE Positions	3.0	3.0	3.5	3.5	3.5	3.5	5.5	5.5	5.5	5.5
Salaries & Wages	\$ 206	\$ 181	\$ 547	\$ 256	\$ 268	\$ 524	\$ 794	\$ 391	\$ 403	\$ 794
Employee Benefits	99	103	382	153	161	314	519	257	262	519
TOTAL PERSONNEL SERVICES	\$ 305	\$ 284	\$ 929	\$ 409	\$ 429	\$ 838	\$ 1,313	\$ 648	\$ 665	\$ 1,313
MATERIALS & SERVICES										
Professional & Technical Services	5	2	24	13	10	23	24	12	12	24
General Office Supplies	18	30	54	34	13	47	62	31	31	62
Dues & Subscriptions	1	1	2	1	1	2	3	2	2	3
Education & Training	1	-	8	4	4	8	11	6	6	11
Electronic Records Management System	33	33	68	33	15	48	68	34	34	68
TOTAL MATERIALS & SERVICES	58	66	156	85	43	128	168	84	84	168
CITY RECORDER TOTAL	\$ 363	\$ 350	\$ 1,085	\$ 494	\$ 472	\$ 966	\$ 1,481	\$ 732	\$ 749	\$ 1,481



RS248

GENERAL FUND GENERAL GOVERNMENT

DEPARTMENT DESCRIPTION AND CORE SERVICES

Under the direction of the Finance Department, general government provides a cost center for citywide expenditures including general insurance premiums, self-insured claims, and neighborhood district association grants. This department accounts for expenditures in the General Fund that are not associated to specific activities of any one department.

ACCOMPLISHMENTS BN 2023-2024

Each of the two loans paid through general government were paid on time.

PRIORITIES BN 2025-2026



Continue annual financial distribution to the seven neighborhood district associations to assist in funding community programs and events



Provide direct financial utility assistance to eligible customers

PERFORMANCE MEASURES

Value	Metric	FY 2021	FY 2022	FY 2023	Estimated		
					FY 2024	FY 2025	FY 2026
Accountable	# of property/liability claims issued to the city	16	10	10	11	10	10
	# of claims handled through the city insurance	12	15	10	14	11	11



FINANCIAL SUMMARY – GENERAL GOVERNMENT

(Amounts in Thousands: \$100 = \$100,000)

	HISTORICAL		BN 2023-2024 CURRENT OUTLOOK				BN 2025-2026			
	Actual FY 2021	Actual FY 2022	Amended Budget	Actual FY 2023	Estimated FY 2024	Estimated BN Total	Proposed Total	Approved FY 2025	Approved FY 2026	Approved Total
MATERIALS & SERVICES										
Professional & Technical Services:										
General Insurance Premiums	\$ 415	\$ 412	\$ 1,085	\$ 488	\$ 569	\$ 1,057	\$ 1,219	\$ 597	\$ 621	\$ 1,219
Neighborhood Grants & Insurance	32	32	64	33	32	65	64	32	32	64
Interest Expense	-	194	-	-	-	-	-	-	-	-
Dues & Subscriptions	15	16	34	17	18	35	34	17	17	34
Emergency Utility Assistance	3	5	10	-	-	-	10	5	5	10
Risk Management & Self Insurance Claims	-	2	10	6	3	9	20	10	10	20
TOTAL MATERIALS & SERVICES	465	661	1,203	544	622	1,166	1,347	661	685	1,347
DEBT SERVICE										
PERS Bond to fund UAL (2006)	416	330	937	370	437	807	937	457	480	937
SPWF Loan from State (2008)	45	151	93	135	134	269	93	47	46	93
TOTAL DEBT SERVICE	461	481	1,030	505	571	1,076	1,030	504	526	1,030
TRANSFERS TO OTHER FUNDS										
City Hall	-	-	500	500	70	570	-	-	-	-
Debt Service	-	-	456	228	228	456	627	314	314	627
Construction Excise Tax (CET)	132	-	800	800	-	800	-	-	-	-
Other Funds	209	-	-	-	-	-	-	-	-	-
System Development Charges	23	-	-	-	-	-	-	-	-	-
TOTAL TRANSFERS OUT	364	-	1,756	1,528	298	1,826	627	314	314	627
GENERAL GOVERNMENT TOTAL	1,290	1,142	3,989	2,577	1,491	4,068	3,004	1,479	1,525	3,004
RESERVES - GENERAL FUND										
Contingency	-	-	2,050	-	-	-	1,737	-	2,050	2,050
Unappropriated Ending Fund Balance	12,921	15,655	4,917	13,423	12,275	12,275	7,528	10,168	7,530	7,528
TOTAL RESERVE GENERAL FUND	12,921	15,655	6,967	13,423	12,275	12,275	9,265	10,168	9,579	9,577
TOTAL	\$ 14,211	\$ 16,797	\$ 10,956	\$ 16,000	\$ 13,766	\$ 16,343	\$ 12,269	\$ 11,646	\$ 11,104	\$ 12,581

GENERAL FUND

LIBRARY

DEPARTMENT DESCRIPTION AND CORE SERVICES

The Milwaukie Ledding Library provides a safe, welcoming place where people of all ages can connect and engage with each other and through resources. The Library supports various backgrounds, experiences, and points of view by providing diverse library collections and public programming. By supporting individuals' pursuit of education and personal goals through informational, recreational, and cultural materials and services, the Library upholds intellectual freedom and the access and guidance to information, technology, and collections.

The Milwaukie Ledding Library is a member of the county-wide consortium of 13 public libraries, working together to provide the best possible service to the people of Clackamas County. This network provides a courier that delivers materials between libraries, a shared catalog for searching, and shared software to circulate library materials. The Library District of Clackamas County provides stable funding for library operations in Clackamas County, including the Milwaukie Ledding Library.

The Library receives support and guidance from multiple groups, including the Library Board, the Friends of the Ledding Library (Friends), and the Ledding Library Foundation of Milwaukie (Foundation). The Library Board advises staff and City Council regarding the needs of the library and its patrons, as well as establishes an annual work plan to identify various projects assigned by the municipal code. The Friends are a volunteer-run non-profit organization that provides significant financial support to supplement the library's budget for collection development and programming. The Foundation, an independent non-profit organization, supports library capital improvement projects. Additionally, Ready to Read grants and other miscellaneous sources support the Library.

The Library is funded through the county-wide library district with a permanent tax rate adopted by voters in 2008 and the city's General Fund property tax dollars. Dedicated staff provide high-level customer service, programming, and resources to the diverse and ever-changing community, including the following core services:

- Provide books and other materials that reflect the diversity of the community
- Maintain welcoming and safe spaces including public meeting rooms
- Provide early literacy support and initiatives to children and families
- Support educational needs and lifelong learning for people of all ages, including free and reliable computer access, and staff assistance at service desks.
- Engage in partnerships and programs for reaching underserved populations

ACCOMPLISHMENTS BN 2023-2024

- Collaborated with community partners, including Milwaukie Police Department, Central City Concern, LoveOne, The Father's Heart Street Ministry, and 4D Recovery, to help connect Milwaukians most in need of resources and regularly support staff and the public. Support included outreach visits and referrals to the police department's behavior health specialist.
- Streamlined and improved scheduling, patron incident reporting, and communications by implementing software solutions
- Expanded technology access for the public by upgrading internet stations to full computers, adding specialized camera equipment for virtual meetings, and adding wall-mounted monitors with multimedia interface hook-ups to meeting rooms

ACCOMPLISHMENTS BN 2023-2024 (CONTINUED)

- Improved internal scheduling and communications to ensure all library staff were able to attend citywide meetings, workshops, and trainings
- Partnered with North Clackamas School District to provide 698 youths free lunch at the library and also provide year-round support for youths without transportation to the library
- Supported sustainability and climate action goals by providing new EV parking spots, hosting repair fairs, attending community sustainability fair, repairing broken items and adding additional in-demand items for the Library of Things collection, and promoting and expanding the seed library
- Supported cultural programs, including Milwaukie High School's Asian American Pacific Islanders Club dance performance, Azteca Tiahui Dance group for Hispanic Heritage Month, bilingual singer Nathalia, and Lunar New Year Lion Dance, by hosting events and contributing staff support
- Partnered with Ready Set Go, Head Start, Healthy Families, and teen parents at the PACE center for early literacy outreach
- Created Teen Advisory Board and increased teen programming
- Reincorporated indoor in-person programs including a successful Fall Author Series featuring LGBTQIA+ and BIPOC authors

PRIORITIES BN 2025-2026



Provide training opportunities to all library staff



Ensure library materials reflect diverse voices



Maintain early literacy efforts and children's programming, as well as adult programming, and generally only expand in areas supporting city strategic goals, sustainability, and underserved voices and communities



Continue training between library divisions to better support staff during times of transition and workload shifts



Continue development and training of person-in-charge team to support and prepare for challenging situations



Enhance partnerships with other city departments and community partners to help Milwaukians most in need



Enrich partnerships with Friends and the Foundation



Evaluate the library's hours of operation based on community input and staffing and budget capacity



Consider ways to improve patron experience and provide opportunities for staff to better support each other and the public by assessing the building's floor plan

CHANGES TO SERVICE

Review operating hours compared to peer organizations and review community expectations to balance hours offered, staffing availability, and ability to meet the needs of the community.

PERFORMANCE MEASURES

Value	Metric	FY 2021	FY 2022	FY 2023	Estimated		
					FY 2024	FY 2025	FY 2026
Accessible	# of library visitors	39,732	149,854	192,823	212,000	223,000	235,000
	# of materials circulated	324,896	570,967	619,636	663,000	709,000	758,000
	# of books downloaded	52,306	49,452	60,591	79,968	104,000	136,000
	# of public computer and WiFi uses	819	12,743	14,146	28,692	30,000	32,000
	# of new patrons added	1,094	3,398	3,967	4,050	4,130	4,200
	# of program attendees	11,903	9,364	15,193	28,620	29,000	30,000
	# of reservations of public meeting rooms	n/a	n/a	2,877	2,900	2,930	2,960
Equitable	# of early literacy based programs	n/a	n/a	152	150	150	150
	# of equity, inclusion and justice programs	n/a	n/a	211	185	185	185
	# of climate / sustainability programs	n/a	n/a	1	5	5	5
	# of programs	264	183	393	408	400	400

FINANCIAL SUMMARY – LIBRARY

(Amounts in Thousands: \$100 = \$100,000)

	HISTORICAL		BN 2023-2024 CURRENT OUTLOOK				BN 2025-2026			
	Actual FY 2021	Actual FY 2022	Amended Budget	Actual FY 2023	Estimated FY 2024	Estimated BN Total	Proposed Total	Approved FY 2025	Approved FY 2026	Approved Total
PERSONNEL SERVICES										
Budgeted FTE Positions	18.25	18.01	18.25	18.25	18.25	18.25	18.25	18.25	18.25	36.50
Salaries & Wages	\$ 1,074	\$ 1,226	\$ 2,580	\$ 1,224	\$ 1,270	\$ 2,494	\$ 2,610	\$ 1,286	\$ 1,324	\$ 2,610
Employee Benefits	594	665	1,404	654	725	1,379	1,615	799	816	1,615
TOTAL PERSONNEL SERVICES	1,668	1,891	3,984	1,878	1,995	3,873	4,225	2,085	2,140	4,225
MATERIALS & SERVICES										
General Office Supplies	19	40	50	29	14	43	36	18	18	36
Education & Training	1	4	40	5	12	17	40	20	20	40
Books & Programs	152	165	350	163	112	275	360	180	180	360
Rents & Leases	13	15	40	22	20	42	24	12	12	24
Miscellaneous	-	-	18	6	-	6	33	33	-	33
TOTAL MATERIALS & SERVICES	185	224	498	225	158	383	493	263	230	493
LIBRARY TOTAL	\$ 1,853	\$ 2,115	\$ 4,482	\$ 2,103	\$ 2,153	\$ 4,256	\$ 4,718	\$ 2,348	\$ 2,370	\$ 4,718



RS254

GENERAL FUND

POLICE

DEPARTMENT DESCRIPTION AND CORE SERVICES

The Milwaukie Police Department protects life and property and treats all residents with respect and dignity. Its mission is to enhance community livability by implementing problem solving partnerships, actively educating the community in safety, building trust, and maintaining a publicly safe environment where integrity and high standards of professionalism prevail.

The Milwaukie Police Department provides administration, operation, and support services, including crime prevention, enforcement, investigations, management of public disorder, quality of life issues, emergency, and disaster response. The department's core services include:

- Seek opportunities for positive community engagement
- Respond to calls for service
- Traffic enforcement and investigation
- Criminal investigation including follow-up detective investigations
- Property and evidence management
- Major crime investigations
- Support of state and federal task force operations
- Provide quality public safety services to the Milwaukie community

ACCOMPLISHMENTS BN 2023-2024

- Hired its first behavioral health specialist (BHS), who made contact with over 200 people in need and helped place 13 people into long-term housing
- Partnered with local non-profit organizations LoveOne and Central City Concern to hire a housing outreach specialist and case manager to help Milwaukie's houseless population
- Procured body worn cameras to deploy to patrol officers, creating a program designed to increase transparency, accountability, and community trust
- Continued participation in cooperative regional efforts that provide security to residents. Participated with several agencies, including Clackamas County Major Crimes Team, Interagency Drug Task Force, and Clackamas County SWAT/HNT Team, as well as involvement with interagency human trafficking missions.
- Awarded three officers with a meritorious service award for life saving actions
- Maintained commitment to public outreach through programs like shred day, prescription drug turn-in, Coffee with a Cop, Craft with a Cop, and participated in monthly neighborhood district association and Public Safety Advisory Committee meetings
- Continued a leadership role in the Clackamas Community Alliance county-wide opioid response team and in the Project Hope response to opioid overdoses, including presenting and promoting the collaborative program to other agencies and other states at the Rx Drug Abuse and Heroin Summit
- Maintained partnership with American Legion to continue the Corporal Diffie Fund, a veterans outreach program to bridge the gap and provide funding and resources to veterans in crisis
- Committed to serving on the Emergency Medical Services Council, which advises the Board of County Commissioners on county-wide matters to improve and manage emerging challenges and services

ACCOMPLISHMENTS BN 2023-2024 (CONTINUED)

- Committed to serving on the Local Public Safety Coordinating Council, which emphasizes the prevention of criminal activity and enhanced community safety
- Provided career development, training, and leadership opportunities for ongoing succession planning and in the Acting Watch Commander program, which allows certain officers with appropriate training and experience to serve in an acting supervisory capacity to gain needed on the job experience while being mentored by overlapping supervisors
- Continued to enhance relationships, engagement, and trust with Milwaukie's BIPOC community through combinations of one-on-one and small group meetings with key stakeholders

PRIORITIES BN 2025-2026



Continue to recruit, train, and deploy police officers committed to public service and safety



Through implementation of new technologies, enhance the use of analytics, data, and intelligence-led policing strategies to maintain a high standard of service and safety to the city



Continue to collaborate with community groups, city departments, and other law enforcement partners to develop effective strategies for maintaining a safe and livable community



Support Law Enforcement Assisted Diversion through funding and partnerships with Clackamas County Department of Health, Housing and Human Services, the district attorney's office, and Central City Concern for a pre-arrest diversion program. The program will reduce the burden on the justice system related to low-level drug offenses and the houseless populations, and emphasizes treatment options over incarceration.



Work in partnership with the Equity Steering Committee to continue engagement with the BIPOC community

PERFORMANCE MEASURES

Value	Metric	FY 2021	FY 2022	FY 2023	Estimated		
					FY 2024	FY 2025	FY 2026
Efficient	# of priority one calls deploying officers	98	70	75	89	83	83
	# of priority two calls deploying officers	2,903	2,800	2,757	2,788	2,812	2,812
	average response time to a priority one call	3:22	2:47	3:10	3:46	3:15	3:18
	average response time to a priority two call	4:33	5:40	6:15	4:36	4:12	4:15
Collaborative	# of alarm calls by businesses and residences	522	435	437	515	477	477
Accessible	# of connections officers had with community members for relationship building	17,014	17,939	20,436	17,387	18,194	18,194
Accountable	# of traffic citations issued	1,025	1,122	1,814	1,373	1,334	1,334
	# of cases with injury traffic crashes	26	39	27	26	30	30
	# of cases with non-injury traffic crashes	98	101	102	105	102	102
	# of total traffic accidents	165	193	182	170	178	178

FINANCIAL SUMMARY – POLICE DEPARTMENT

(Amounts in Thousands: \$100 = \$100,000)

	HISTORICAL		BN 2023-2024 CURRENT OUTLOOK				BN 2025-2026			
	Actual FY 2021	Actual FY 2022	Amended Budget	Actual FY 2023	Estimated FY 2024	Estimated BN Total	Proposed Total	Approved FY 2025	Approved FY 2026	Approved Total
PERSONNEL SERVICES										
Budgeted FTE Positions	38.50	38.50	38.50	38.50	38.50	38.50	40.50	40.50	40.50	40.50
Salaries & Wages	\$ 3,796	\$ 3,816	\$ 8,865	\$ 4,215	\$ 4,067	\$ 8,282	\$ 8,747	\$ 4,292	\$ 4,455	\$ 8,747
Employee Benefits	2,191	2,201	5,066	2,417	2,375	4,792	6,554	3,229	3,325	6,554
TOTAL PERSONNEL SERVICES	\$ 5,987	\$ 6,017	\$ 13,931	\$ 6,632	\$ 6,442	\$ 13,074	\$ 15,301	\$ 7,521	\$ 7,780	\$ 15,301
MATERIALS & SERVICES										
Professional & Technical Services:										
911 Dispatch (LOCOM)	433	454	1,027	478	501	979	1,155	563	592	1,155
Other	125	177	396	128	200	328	522	261	261	522
General Office Supplies	9	20	30	22	28	50	70	35	35	70
Dues & Subscriptions	1	1	4	3	1	4	8	4	4	8
Education & Training	41	72	180	85	40	125	200	100	100	200
Public Safety Supplies	90	135	250	127	180	307	260	130	130	260
TOTAL MATERIALS & SERVICES	699	859	1,887	843	950	1,793	2,215	1,093	1,122	2,215
CAPITAL OUTLAY										
Furniture & Equipment	-	-	-	225	-	225	30	15	15	30
Vehicles	185	59	330	150	140	290	420	240	180	420
TOTAL CAPITAL OUTLAY	185	59	330	375	140	515	450	255	195	450
POLICE TOTAL	\$ 6,871	\$ 6,935	\$ 16,148	\$ 7,850	\$ 7,532	\$ 15,382	\$ 17,966	\$ 8,869	\$ 9,097	\$ 17,966

EXPLANATION OF SIGNIFICANT BUDGET CHANGES

Police materials and services budget increased by \$328,000 when compared to prior biennium budget due to:

- 1) Increase of \$62,000 for the dispatch contract with Lake Oswego Communications (LOCOM) from FY2024 to FY 2025.
- 2) Increase of \$126,000 for both FY25 and FY 26 in other professional and technical services include the following significant items:
 - a. Police Reporting System (\$31,000) per year
 - b. Clackamas 800 Radios (anticipated costs of \$83,500 in FY 25 and FY 26)
 - c. Body Worn Cameras (\$20,000)
 - d. Taser support services (\$20,000) and online law enforcement training services (\$15,500 per year)
 - e. Property and evidence software (\$16,700 per year)
- 3) Increase of \$20,000 for biennium for education and training due to ongoing training needs for officers, inflation, and increased FY training costs.
- 4) Increase of \$75,000 in Vehicles. Per vehicle cost has increased from \$55,000 to \$60,000 per vehicle, which also includes price of upfitting for secure storage boxes, custody area, emergency lights, and related equipment. Police typically purchase three vehicles per year but in this biennium one additional vehicle is added to FY 2025 to reflect a vehicle deemed a total loss in FY2024.



RS258

DEBT SERVICE FUND

DEPARTMENT DESCRIPTION AND CORE SERVICES

The Debt Service Fund accounts for the payment of principal, interest and fiscal charges on general obligation bonds and full faith and credit obligations. As stated in the city's Financial and Debt Management Policies section, debt includes municipal bonds, interfund loans, equipment financing, and promissory notes as approved methods for financing capital projects.

In July 2014, the city issued \$3,695,000 in general obligation bonds to refinance the 2012 TriMet loan that funded the Portland-Milwaukie light rail capital enhancements. The true interest cost of the bonds is 2.86% with interest rates varying by year between 3% and 4%. The maturity date on these bonds is June 1, 2034.

In September 2014, the city issued \$965,000 in full faith and credit obligations to fund the second phase of the Milwaukie Bay Park project and to serve as the city's match against local, state, and federal grants. The true interest cost of the obligations is 2.71% with interest rates varying by year between 3% and 4%. The maturity date on these obligations is June 1, 2029.

In August 2016, the city issued \$9,200,000 in general obligation bonds to fund the Ledding Library project. The true interest cost of the bonds is 2.26% with interest rates varying by year between 2% and 4%. The maturity date on these bonds is June 15, 2036.

In July 2018, the city issued \$20,970,000 in full faith and credit obligations to fund the Safe Access For Everyone program and improve safety for people walking, biking and more. The true interest cost of the obligations is 3.72% with interest rates varying by year between 3.5% and 5%. The maturity date on these obligations is June 15, 2048.



In June 2020, the city issued \$6,700,000 in full faith and credit obligations (taxable) to purchase and renovate a new city hall. The true interest cost of the obligations is 2.60% with interest rates varying by year between .84% and 2.99%. The maturity date is June 15, 2040. The debt service payments were repaid in FY 2021 and FY 2022 by the current tenant through a lease back provision of the purchase.

In February 2023, the city issued \$23,531,600 in full faith and credit obligations (taxable) to fund transportation and urban renewal capital projects. The true interest cost of the obligations is 3.96%. The maturity date is June 15, 2042.

ACCOMPLISHMENTS BN 2023-2024

Continue monitoring the Debt Service Fund to account for principal and interest payments of general obligation bonds and full faith and credit obligations

PRIORITIES BN 2025-2026

-  Fulfill obligations for continuing disclosure requirements under the Securities and Exchange Commission Rule 15c2-12 by filing audited financial reports and other required disclosures with the Municipal Securities Rulemaking Board Electronic Municipal Market Access database service which is available at www.emma.msrb.org
-  Process payments timely to avoid late fees and charges

PERFORMANCE MEASURES

Value	Metric	FY 2021	FY 2022	FY 2023	Estimated		
					FY 2024	FY 2025	FY 2026
Accountable	# credit rating issued to city by independent agency	Aa2	Aa2	Aa2	Aa2	Aa2	Aa2
	# of debt issuances completed	0	0	1	0	0	0
	\$ amount of total debt outstanding citywide (in millions)	\$38	\$39	\$60	\$58	\$56	\$54
	% of ontime payments to debt issuers	100%	100%	100%	100%	100%	100%

FINANCIAL SUMMARY – DEBT SERVICE FUND

(Amounts in Thousands: \$100 = \$100,000)

	HISTORICAL		BN 2023-2024 CURRENT OUTLOOK				BN 2025-2026			
	Actual FY 2021	Actual FY 2022	Amended Budget	Actual FY 2023	Estimated FY 2024	Estimated BN Total	Proposed Total	Approved FY 2025	Approved FY 2026	Approved Total
RESOURCES										
BEGINNING FUND BALANCE	\$ 360	\$ 442	\$ 9	\$ 9	\$ 243	\$ 9	\$ 53	\$ 53	\$ 58	\$ 53
Property Taxes	862	856	1,720	860	859	1,719	1,714	854	860	1,714
Intergovernmental	85	83	168	168	-	168	172	85	87	172
Interest Income	6	2	-	24	16	40	10	5	5	10
Transfers from Other Funds	504	-	868	560	308	868	865	432	433	865
TOTAL RESOURCES	\$ 1,817	\$ 1,383	\$ 2,765	\$ 1,621	\$ 1,426	\$ 2,804	\$ 2,814	\$ 1,429	\$ 1,443	\$ 2,814
REQUIREMENTS										
DEBT SERVICE - PRINCIPAL										
Series 2014 FFCO - Milwaukee Bay Park	60	60	130	65	65	130	145	70	75	145
Series 2014 GO Bond - Lighttrail	160	165	350	170	180	350	380	185	195	380
Series 2016 GO Bond - Library	390	395	830	410	420	830	880	430	450	880
Series 2020 FFCO - City Hall	280	285	580	290	290	580	595	295	300	595
TOTAL DEBT SERVICE - PRINCIPAL	890	905	1,890	935	955	1,890	2,000	980	1,020	2,000
DEBT SERVICE - INTEREST										
Series 2014 FFCO - Milwaukee Bay Park	25	23	38	20	18	38	27	15	12	27
Series 2014 GO Bond - Lighttrail	103	98	175	90	83	173	145	76	69	145
Series 2016 GO Bond - Library	208	200	365	188	176	364	309	163	146	309
Series 2020 FFCO - City Hall	149	148	286	145	141	286	270	137	133	270
TOTAL DEBT SERVICE - INTEREST	485	469	864	443	418	861	751	391	360	751
TOTAL PROGRAM REQUIREMENTS	1,375	1,374	2,754	1,378	1,373	2,751	2,751	1,371	1,380	2,751
Unappropriated Ending Fund Balance	442	9	11	243	53	53	63	58	63	63
TOTAL REQUIREMENTS	\$ 1,817	\$ 1,383	\$ 2,765	\$ 1,621	\$ 1,426	\$ 2,804	\$ 2,814	\$ 1,429	\$ 1,443	\$ 2,814

BUILDING FUND

DEPARTMENT DESCRIPTION AND CORE SERVICES

The Building Department is committed to ensuring the safety of public buildings and private residences through the proficient administration of state specialty codes adopted in Oregon. The department provides accurate, dependable, and high-quality services to residents and stakeholders.

The Building Department meticulously regulates requirements to safeguard public health, safety, general welfare, and the environment. This is achieved through the application of state building codes, which establish minimum standards for the construction, modification, and occupation of buildings. The overarching purpose of the department is to:

- Ensure code compliance for structural, mechanical, electrical, plumbing, fire life safety, and energy conservation aspects of buildings
- Conduct thorough plan reviews and inspections for both public and privately-owned structures
- Address customer inquiries and promptly resolve code compliance issues
- Facilitate accessibility and comprehension of construction codes and regulations
- Collaborate seamlessly with the Community Development Department and other city departments to coordinate efforts on development projects

ACCOMPLISHMENTS BN 2023-2024

- Spearheaded the completion of Seven Acres' 234-unit apartment complex
- Completion of the 6-story Henley Place apartment building adding 178 living units to downtown Milwaukie
- Began construction on 189,00 square feet of an independent and assisted living facility that will provide 170 units to the community
- Secured plans for the Hillside Development project, initiating a 500-unit affordable housing endeavor with an anticipated completion date by early 2027
- Completed the first cottage cluster within city limits following guidelines of House Bill 2001 middle-housing with an additional 100 cottage cluster units to be completed by 2025
- Reduced turnaround time by 25% for plans examination
- Completed comprehensive remodel of new city hall, ensuring the establishment of a structurally sound and safer municipal facility
- Executed the first of a three-phase development of Birnum Oaks luxury apartments and contributed to the advancement of the project
- Successfully conducted 98% of requested inspections within a single business day to provide efficiency and prompt service delivery to customers
- Demonstrated exceptional customer service while operating remotely, consistently responding to phone calls and emails within two-business days

PRIORITIES BN 2025-2026



Ensure a superior standard of customer service for the public, development community, and city departments by ensuring timely responses to communications within two-business days



Facilitate consistent and effective administration of various adopted specialty codes by delivering ongoing education to department staff on code updates



Foster self-improvement by offering training opportunities to aid staff in achieving goals



Implement proactive monitoring of electronic submissions and maintain efficient communication with internal and external stakeholders



Fill in-house commercial inspector/plans examiner position to further improve review processes and timeframes



Collaborate with community partners to establish warming shelters and cooling stations, demonstrating a commitment to community well-being

CHANGES TO SERVICE

Building Department will revamp the short-term rental program to achieve significant customer cost savings and expedite turnaround times. The department will also overhaul its permitting procedures to reduce intake and plans examining turnaround times, plus implement a streamlined permit acceptance and issuance procedure to enhance accessibility and optimize the overall process.

PERFORMANCE MEASURES

Value	Metric	FY 2021	FY 2022	FY 2023	Estimated		
					FY 2024	FY 2025	FY 2026
Efficient	# of permits issued	1,655	1,792	1,432	1,500	1,450	1,400
	# of inspections performed	4,900	4,695	3,597	4,000	4,200	4,000
	# plan reviews performed	585	374	349	475	450	425
	# of active permits per month (average)	1,161	1,356	1,071	1,200	1,150	1,100



FINANCIAL SUMMARY – BUILDING FUND

(Amounts in Thousands: \$100 = \$100,000)

	HISTORICAL		BN 2023-2024 CURRENT OUTLOOK				BN 2025-2026			
	Actual FY 2021	Actual FY 2022	Amended Budget	Actual FY 2023	Estimated FY 2024	Estimated BN Total	Proposed Total	Approved FY 2025	Approved FY 2026	Approved Total
RESOURCES										
BEGINNING FUND BALANCE	\$ 2,295	\$ 2,569	\$ 3,586	\$ 3,470	\$ 4,561	\$ 3,470	\$ 4,788	\$ 4,788	\$ 4,804	\$ 4,788
Fees and Charges	1,045	1,917	1,667	1,918	1,053	2,971	2,568	1,432	1,136	2,568
Interest Income	18	10	30	120	118	238	150	75	75	150
Miscellaneous	1	3	-	3	5	8	4	2	2	4
TOTAL RESOURCES	\$ 3,359	\$ 4,499	\$ 5,283	\$ 5,511	\$ 5,737	\$ 6,687	\$ 7,510	\$ 6,297	\$ 6,017	\$ 7,510
REQUIREMENTS										
PERSONNEL SERVICES										
Salaries	239	258	560	255	273	528	580	286	294	580
Benefits	163	172	388	163	177	340	382	189	193	382
TOTAL PERSONNEL SERVICES	402	430	948	418	450	868	962	475	487	962
MATERIALS & SERVICES										
Professional & Technical Services	114	239	280	294	251	545	1,240	630	610	1,240
General Office Supplies	-	4	20	1	12	13	20	10	10	20
Fees & Licenses	-	35	22	15	22	37	32	32	-	32
Dues & Subscriptions	1	1	8	-	1	1	4	2	2	4
Education & Training	3	5	14	2	3	5	10	5	5	10
Miscellaneous	-	25	-	10	-	10	-	-	-	-
TOTAL MATERIALS & SERVICES	118	309	344	322	289	611	1,306	679	627	1,306
Capital Outlay	-	-	-	-	-	-	134	100	34	134
Transfers to Other Funds	270	290	420	210	210	420	478	239	239	478
Contingency	-	-	400	-	-	-	-	700	680	680
TOTAL PROGRAM REQUIREMENTS	790	1,029	2,112	950	949	1,899	2,880	2,193	2,067	3,560
Unappropriated Ending Fund Balance	2,569	3,470	3,171	4,561	4,788	4,788	4,630	4,104	3,950	3,950
TOTAL REQUIREMENTS	\$ 3,359	\$ 4,499	\$ 5,283	\$ 5,511	\$ 5,737	\$ 6,687	\$ 7,510	\$ 6,297	\$ 6,017	\$ 7,510

	Actual FY 2021	Actual FY 2022	Amended Budget	Actual FY 2023	Estimated FY 2024	Estimated BN Total	Proposed Total	Approved FY 2025	Approved FY 2026	Approved Total
BUDGETED POSITIONS										
Full-Time Equivalent (FTE) Employee #	3.0	3.0	3.0	3.0	3.0	3.0	4.0	4.0	4.0	4.0
Population	20,556	20,600	20,600	21,235	21,235	21,235	21,341	21,341	21,341	21,341
MONTHLY OPERATING COSTS PER CAPITA	\$ 3	\$ 4	\$ 7	\$ 4	\$ 4	\$ 7	\$ 11	\$ 5	\$ 5	\$ 11
POLICY REQUIREMENTS										
Contingency & Ending Fund Balance Above	2,569	3,470	3,571	4,561	4,788	4,788	4,630	4,804	4,630	4,630
Policy Requirement (50%)	400	510	860	480	470	950	1,370	700	680	1,370
AMOUNT OVER (UNDER) POLICY REQUIREMENT	\$ 2,169	\$ 2,960	\$ 2,711	\$ 4,081	\$ 4,318	\$ 3,838	\$ 3,260	\$ 4,104	\$ 3,950	\$ 3,260



RS264

CONSTRUCTION EXCISE TAX FUND

DEPARTMENT DESCRIPTION AND CORE SERVICES

The Construction Excise Tax (CET) Fund is managed by the Community Development Department which oversees, administers, and implements the city policies and goals related to affordable housing and economic development. The department also facilitates relationships with public, private, and nonprofit partners to advance city objectives related to affordable housing.

City Council unanimously passed ordinance no. 2154 and Milwaukie Municipal Code Chapter 3.60 to establish the CET that went into effect in 2018. CET is a 1% tax on the construction value for projects over \$100,000. The revenue generated from residential valuation is dedicated to affordable housing incentives, while the revenue generated from commercial valuation is split between affordable housing and economic development initiatives. The dedication of revenue is outlined in Section 3.60.130 of the Milwaukie Municipal Code, which states:

1. The city may retain up to four percent (4%) of the tax collected for payment toward administrative expenses related to collection and distribution of the tax.
2. The net revenue from the tax on residential improvements will be allocated by the city as follows:
 - a. 15% of net revenue will be remitted to the Oregon Department of Housing and Community Services to fund home ownership programs;
 - b. 50% of net revenue will fund incentives for the development and construction of affordable housing authorized by the city, as provided by state law; and
 - c. 35% of net revenue will fund programs and activities related to affordable housing.
3. The net revenue from the tax on commercial improvements will be distributed as follows:
 - a. 50% to fund incentives for the development and construction of housing that is affordable at up to 120% of median family income; and
 - b. 50% for economic development programs with an emphasis on areas of the city that are subject to plans designated as eligible by the city. The eligible plans as of the effective date of the ordinance codified in this chapter are: Central Milwaukie Land Use and Transportation Plan, Downtown and Riverfront Land Use Framework Plan, Milwaukie Urban Renewal Plan, Economic Development Strategic Plan and the North Milwaukie Industrial Area Plan. Additional eligible plans may be designated by the City Council. (Ord. 2154 § 1, 2017)

ACCOMPLISHMENTS BN 2023-2024

Community Development Department created and implemented the inaugural affordable housing grant program, which awarded \$2 million in CET funds and supported the development of over 400 new income-restricted units in Milwaukie.

PRIORITIES BN 2025-2026



Develop and implement economic development grant programs to support local businesses



Monitor and support developers awarded CET-funded affordable housing project grants to ensure obligations continue to be met

CHANGES TO SERVICE

A large portion of CET funds were used to fund affordable housing projects in the last biennium. Those funds will need to accrue once again before the city is able to provide further funding. Staff anticipates expensing CET funds related to economic development programming and grants in this next biennium – this will be a new service for the community.

PERFORMANCE MEASURES

Value	Metric	FY 2021	FY 2022	FY 2023	Estimated		
					FY 2024	FY 2025	FY 2026
Equitable	# of affordable housing units supported	n/a	0	400	0	0	200
Collaborative	# of businesses supported	n/a	0	0	0	10	10
Accountable	\$ total amount of funding disbursed	n/a	0	2,000,000	0	250,000	250,000

FINANCIAL SUMMARY – CONSTRUCTION EXCISE TAX FUND

(Amounts in Thousands: \$100 = \$100,000)

	HISTORICAL		BN 2023-2024 CURRENT OUTLOOK				BN 2025-2026			
	Actual FY 2021	Actual FY 2022	Amended Budget	Actual FY 2023	Estimated FY 2024	Estimated BN Total	Proposed Total	Approved FY 2025	Approved FY 2026	Approved Total
RESOURCES										
BEGINNING FUND BALANCE	\$ 400	\$ 665	\$ 950	\$ 1,267	\$ 3,015	\$ 1,267	\$ 1,440	\$ 1,440	\$ 1,381	\$ 1,440
EXCISE TAX										
50% Commercial Affordable Housing Development Tax	10	125	324	447	25	472	200	100	100	200
50% Commercial Economic Development Incentives Tax	10	125	800	447	25	472	200	100	100	200
50% Residential Affordable Housing Development Tax	60	192	312	18	25	43	40	20	20	40
35% Residential Affordable Housing Activities Tax	42	135	8	13	20	33	28	14	14	28
Intergovernmental	132	-	123	-	-	-	-	-	-	-
Interest Income	5	4	11	49	41	90	20	10	10	20
Miscellaneous	6	26	28	39	4	43	20	10	10	20
Transfers from Other Funds	132	-	800	800	-	800	-	-	-	-
TOTAL RESOURCES	\$ 797	\$ 1,272	\$ 3,356	\$ 3,080	\$ 3,155	\$ 3,220	\$ 1,948	\$ 1,694	\$ 1,635	\$ 1,948
REQUIREMENTS										
MATERIALS & SERVICES										
Developer Incentives	-	-	145	-	300	300	-	-	-	-
Economic Development Incentives - Commercial Program & Incentives -Other	-	5	101	-	-	-	-	-	-	-
Affordable Housing Business Relief Grants	132	-	1,000	50	1,000	1,050	-	-	-	-
Business Relief Grants	132	-	123	-	-	-	-	-	-	-
TOTAL MATERIALS & SERVICES	132	5	1,591	50	1,700	1,750	600	300	300	600
Transfers Out	-	-	30	15	15	30	25	13	13	25
Contingency	-	-	22	-	-	-	60	-	60	60
TOTAL PROGRAM REQUIREMENTS	132	5	1,643	65	1,715	1,780	685	313	373	685
Unappropriated Ending Fund Balance	665	1,267	1,713	3,015	1,440	1,440	1,263	1,381	1,263	1,263
TOTAL REQUIREMENTS	\$ 797	\$ 1,272	\$ 3,356	\$ 3,080	\$ 3,155	\$ 3,220	\$ 1,948	\$ 1,694	\$ 1,635	\$ 1,948
POLICY REQUIREMENTS										
Contingency & Ending Fund Balance Above Policy Requirement (17%)	665	1,267	1,735	3,015	1,440	1,440	1,323	1,381	1,323	1,323
Policy Requirement (17%)	22	1	270	9	289	298	102	51	51	102
AMOUNT OVER (UNDER) POLICY REQUIREMENT	\$ 643	\$ 1,266	\$ 1,465	\$ 3,007	\$ 1,151	\$ 1,143	\$ 1,221	\$ 1,330	\$ 1,272	\$ 1,221

TRANSPORTATION FUND

SSMP, SAFE AND STATE GAS TAX

DEPARTMENT DESCRIPTION AND CORE SERVICES

The transportation programs maintain and enhance the city's transportation infrastructure providing safe traveling conditions for pedestrian, bike and vehicular travel. The Transportation Fund consists of three programs:

- Street Surface Maintenance Program (SSMP) provides capital maintenance of the street network. The program paves large portions of arterials and collectors in the city, and includes residential streets with the goal to upgrade pavement condition by a measurable amount in the most cost-effective manner. This program is funded through monthly user fees, Portland General Electric privilege tax, and local gas tax.
- Safe Access for Everyone (SAFE) provides for capital needs of pedestrian and bicycle infrastructure and is a dedicated funding source to implement the Public Right-of-Way ADA Transition Plan and Bicycle and Pedestrian Accessibility Plan. The program is also a supporting funding source to SSMP by providing funding of mandatory ADA upgrades that accompanies SSMP. The SAFE program began in 2017 and will construct infrastructure over 40% of the city's roadways within 25 years, and is funded through monthly user fees.
- State Gas Tax program maintains the street network including pavement, signs, pavement markings, and signals. This program is funded through franchise fees from Water, Wastewater and Stormwater utilities and gas taxes remitted to the city through the state.

ACCOMPLISHMENTS BN 2023-2024

- Proactively responded to requests made through the pothole hotline
- Purchase new 5yd Yard Shared Dump truck and plow
- Corrected draining issues by digging out and regrading slopes, and adding asphalt berms to allow stormwater to enter the storm system
- Placed pavement markings and striping in compliance with the Manual on Uniform Traffic Control Devices standards
- Provided funding for material and labor to crack seal city streets prior to the slurry seal project
- Provided the majority of street paving through construction projects
- Completed approximately 6.2 miles of slurry seal in the summer of 2023
- Completed construction for grind and inlay and slurry seal projects



PRIORITIES BN 2025-2026



Continue to maintain and enhance city infrastructure and traffic control



Maintain safe travel ways and reasonable ride-ability



Complete projects efficiently by meeting budget appropriations, executing less change orders and timely project completion



Maintain signage, pavement markings, and signals



Bring local streets into SSMP as major streets reach a sustainable condition



Upgrade pavement condition in the most cost-effective method

PERFORMANCE MEASURES

Value	Metric	FY 2021	FY 2022	FY 2023	Estimated		
					FY 2024	FY 2025	FY 2026
Efficient	# of miles sealed pavement cracks completed in-house	4.27	2.86	2.79	3	2	2
Accessible	# of miles of snow plowing	45.60	28	18.95	35	35	35
	# of gallons of de-icer placed	170	175	425	225	225	225
Accountable	# of tons of asphalt (hot & cold) to patch potholes	6	149.15	147	200	150	150
	# of linear feet placed with thermo-plastic markings	612	350	1,014	1,100	1,100	1,100
	# of symbols placed with thermo-plastic markings	0	62	76	85	85	85
	# of poles and signs updated and maintained city-wide	192	120	185	200	200	200



FINANCIAL SUMMARY – TRANSPORTATION FUND

(Amounts in Thousands: \$100 = \$100,000)

	HISTORICAL		BN 2023-2024 CURRENT OUTLOOK				BN 2025-2026			
	Actual FY 2021	Actual FY 2022	Amended Budget	Actual FY 2023	Estimated FY 2024	Estimated BN Total	Proposed Total	Approved FY 2025	Approved FY 2026	Approved Total
RESOURCES										
BEGINNING FUND BALANCE	\$ 18,950	\$ 15,220	\$ 10,191	\$ 10,212	\$ 26,867	\$ 10,212	\$ 25,534	\$ 25,534	\$ 15,142	\$ 25,534
FEES & CHARGES										
Street Maintenance Fee	956	981	2,269	1,035	1,080	2,115	2,540	1,235	1,305	2,540
SAFE Fee	1,136	1,175	2,568	1,253	1,296	2,549	2,930	1,415	1,515	2,930
INTERGOVERNMENTAL										
Local Gas Tax	116	122	240	128	117	245	260	130	130	260
State Gas Tax	1,560	1,673	3,128	1,673	1,675	3,348	3,346	1,673	1,673	3,346
County Vehicle Registration Fee	411	394	800	420	420	840	850	425	425	850
Other	389	232	1,950	12	59	71	5,500	2,000	3,500	5,500
Franchise Fees (1.5% Privilege Tax)	338	353	730	369	400	769	798	390	408	798
Franchise Fees (from Utility Funds)*	892	932	2,197	1,094	1,109	2,203	2,223	1,103	1,120	2,223
Interest Income	86	176	260	375	574	949	475	250	225	475
Reimbursement Fee	4	10	-	11	5	16	38	32	6	38
FILOC	14	32	41	-	-	-	20	10	10	20
Miscellaneous	8	46	24	13	3	16	4	2	2	4
Transfers In	49	-	-	-	-	-	-	-	-	-
Proceeds from Issuance of Debt	-	-	21,000	18,883	-	18,883	-	-	-	-
TOTAL RESOURCES	\$ 24,909	\$ 21,346	\$ 45,398	\$ 35,478	\$ 33,605	\$ 42,216	\$ 44,518	\$ 34,199	\$ 25,461	\$ 44,518
REQUIREMENTS										
Personnel Services	563	649	1,364	665	708	1,373	1,447	714	733	1,447
Materials & Services	385	614	1,550	607	457	1,064	1,235	695	540	1,235
Capital Outlay	4,715	7,033	19,638	3,155	2,693	5,848	26,262	13,441	12,846	26,287
Debt Service	1,996	642	3,394	1,948	1,968	3,916	3,974	1,987	1,987	3,974
Transfers to Other Funds	2,030	2,090	4,490	2,236	2,245	4,481	4,490	2,245	2,245	4,490
Contingency	-	-	1,210	-	-	-	134	-	134	134
EXPENDITURE TOTAL	9,689	11,028	31,646	8,611	8,071	16,682	37,542	19,082	18,485	37,567
Unappropriated Ending Fund Balance	15,220	10,212	13,752	26,867	25,534	25,534	6,976	15,117	6,976	6,951
TOTAL REQUIREMENTS	\$ 24,909	\$ 21,240	\$ 45,398	\$ 35,478	\$ 33,605	\$ 42,216	\$ 44,518	\$ 34,199	\$ 25,461	\$ 44,518

*Franchise fees to transportation are from the utility funds dedicating 8% of net revenues per the Municipal Code Section 3.10 passed by Ordinance # 1905 in 2002.

	Actual FY 2021	Actual FY 2022	Amended Budget	Actual FY 2023	Estimated FY 2024	Estimated BN Total	Proposed Total	Approved FY 2025	Approved FY 2026	Approved Total
BUDGETED POSITIONS										
Full-Time Equivalent (FTE) Employee # (State Gas Tax)	5.5	5.5	5.5	5.5	5.5	5.5	6.0	6.0	6.0	6.0
Population	20,556	20,600	20,600	21,235	21,235	21,235	21,341	21,341	21,341	21,341
MONTHLY OPERATING COSTS PER CAPITA	\$ 19	\$ 28	\$ 84	\$ 12	\$ 11	\$ 23	\$ 103	\$ 52	\$ 51	\$ 103
POLICY REQUIREMENTS										
Contingency & Ending Fund Balance Above	9,689	11,028	31,646	8,611	8,071	16,682	18,485	19,082	18,485	18,485
Reserve for Debt Service	1,996	642	3,394	1,948	1,968	3,916	3,974	1,987	1,987	3,974
Policy Requirement (17%)	510	570	1,260	600	580	1,180	1,220	620	600	1,220
AMOUNT OVER (UNDER) POLICY REQUIREMENT	\$ 9,179	\$ 10,458	\$ 30,386	\$ 8,011	\$ 7,491	\$ 15,502	\$ 17,265	\$ 18,462	\$ 17,885	\$ 17,265

THE TRANSPORTATION FUND SUMMARY COMBINES THE FOLLOWING FUND SUMMARIES:

SSMP Fund Summary

(Amounts in Thousands: \$100 = \$100,000)

	HISTORICAL		BN 2023-2024 CURRENT OUTLOOK				BN 2025-2026			
	Actual FY 2021	Actual FY 2022	Amended Budget	Actual FY 2023	Estimated FY 2024	Estimated BN Total	Proposed Total	Approved FY 2025	Approved FY 2026	Approved Total
RESOURCES										
BEGINNING FUND BALANCE	\$ 6,867	\$ 5,840	\$ 4,347	\$ 4,692	\$ 9,855	\$ 4,692	\$ 9,348	\$ 9,348	\$ 6,041	\$ 9,348
Fees & Charges	956	981	2,269	1,035	1,080	2,115	2,540	1,235	1,305	2,540
Intergovernmental										
Local Gas Tax	116	122	240	128	117	245	260	130	130	260
Franchise Fees (1.5% Privilege Tax)	338	353	730	369	400	769	798	390	408	798
Interest Income	65	70	100	122	189	311	100	50	50	100
Proceeds from Issuance of Debt	-	-	6,000	6,207	-	6,207	-	-	-	-
TOTAL RESOURCES	\$ 8,342	\$ 7,366	\$ 13,686	\$ 12,553	\$ 11,641	\$ 14,339	\$ 13,046	\$ 11,153	\$ 7,934	\$ 13,046
REQUIREMENTS										
MATERIALS & SERVICES										
Professional & Technical Services	-	-	115	30	-	30	16	8	8	16
Utility Assistance	-	-	10	5	-	5	10	5	5	10
Bad Debt	11	4	30	-	12	12	20	10	10	20
TOTAL MATERIALS & SERVICES	11	4	155	35	12	47	46	23	23	46
Capital Outlay	1,475	2,055	6,210	1,504	1,116	2,620	6,808	3,856	2,952	6,808
Debt Service	606	195	798	627	630	1,257	1,260	630	630	1,260
Transfers to Other Funds	410	420	1,070	532	535	1,067	1,206	603	603	1,206
Contingency	-	-	100	-	-	-	100	-	100	100
TOTAL PROGRAM REQUIREMENTS	2,502	2,674	8,333	2,698	2,293	4,991	9,420	5,112	4,308	9,420
Unappropriated Ending Fund Balance	5,840	4,692	5,353	9,855	9,348	9,348	3,626	6,041	3,626	3,626
TOTAL REQUIREMENTS	\$ 8,342	\$ 7,366	\$ 13,686	\$ 12,553	\$ 11,641	\$ 14,339	\$ 13,046	\$ 11,153	\$ 7,934	\$ 13,046

SAFE Fund Summary

(Amounts in Thousands: \$100 = \$100,000)

	HISTORICAL		BN 2023-2024 CURRENT OUTLOOK				BN 2025-2026			
	Actual FY 2021	Actual FY 2022	Amended Budget	Actual FY 2023	Estimated FY 2024	Estimated BN Total	Proposed Total	Approved FY 2025	Approved FY 2026	Approved Total
RESOURCES										
BEGINNING FUND BALANCE	\$ 7,623	\$ 5,264	\$ 2,746	\$ 2,643	\$ 10,076	\$ 2,643	\$ 9,038	\$ 9,038	\$ 3,685	\$ 9,038
Fees & Charges	1,136	1,175	2,568	1,253	1,296	2,549	2,930	1,415	1,515	2,930
Intergovernmental	230	174	150	12	-	12	5,500	2,000	3,500	5,500
Interest Income	49	57	80	102	200	302	200	100	100	200
Proceeds from Issuance of Debt	-	-	10,000	8,722	-	8,722	-	-	-	-
TOTAL RESOURCES	\$ 9,038	\$ 6,670	\$ 15,544	\$ 12,732	\$ 11,572	\$ 14,228	\$ 17,668	\$ 12,553	\$ 8,800	\$ 17,668
REQUIREMENTS										
MATERIALS & SERVICES										
Professional & Technical Services	-	-	200	38	-	38	-	-	-	-
Utility Assistance	-	-	10	6	-	6	10	5	5	10
Bad Debt	13	5	20	-	-	-	14	7	7	14
TOTAL MATERIALS & SERVICES	13	5	230	44	-	44	24	12	12	24
Capital Outlay	2,172	3,037	6,851	999	904	1,903	12,771	7,194	5,602	12,796
Debt Service	949	305	1,970	930	945	1,875	1,928	964	964	1,928
Transfers to Other Funds	640	680	1,370	683	685	1,368	1,446	723	723	1,446
Contingency	-	-	360	-	-	-	-	-	-	-
TOTAL PROGRAM REQUIREMENTS	3,774	4,027	10,781	2,656	2,534	5,190	16,169	8,893	7,301	16,194
Unappropriated Ending Fund Balance	5,264	2,643	4,763	10,076	9,038	9,038	1,499	3,660	1,499	1,474
TOTAL REQUIREMENTS	\$ 9,038	\$ 6,670	\$ 15,544	\$ 12,732	\$ 11,572	\$ 14,228	\$ 17,668	\$ 12,553	\$ 8,800	\$ 17,668

¹ \$25,000 in FY 2025 Capital Outlay was missing for Bowman-Brae & Where Else Lane project. Amount correct in CIP but missing in proposed budget table; corrected in Approved Budget.

State Gas Tax Fund Summary

(Amounts in Thousands: \$100 = \$100,000)

	HISTORICAL		BN 2023-2024 CURRENT OUTLOOK				BN 2025-2026			
	Actual FY 2021	Actual FY 2022	Amended Budget	Actual FY 2023	Estimated FY 2024	Estimated BN Total	Proposed Total	Approved FY 2025	Approved FY 2026	Approved Total
RESOURCES										
BEGINNING FUND BALANCE	\$ 4,460	\$ 4,116	\$ 3,098	\$ 2,877	\$ 6,936	\$ 2,877	\$ 7,148	\$ 7,148	\$ 5,416	\$ 7,148
Intergovernmental										
State Gas Tax	1,560	1,673	3,128	1,673	1,675	3,348	3,346	1,673	1,673	3,346
County Vehicle Registration Fee	411	394	800	420	420	840	850	425	425	850
Other	159	58	1,800	-	59	59	-	-	-	-
Franchise Fees (from Utility Funds)*	892	932	2,197	1,094	1,109	2,203	2,223	1,103	1,120	2,223
Interest Income	(28)	49	80	151	185	336	175	100	75	175
Reimbursement Fee - SDC	4	10	-	11	5	16	38	32	6	38
FILOC Revenue	14	32	41	-	-	-	20	10	10	20
Miscellaneous	8	46	24	13	3	16	4	2	2	4
Transfers In	49	-	-	-	-	-	-	-	-	-
Proceeds from Issuance of Debt	-	-	5,000	3,954	-	3,954	-	-	-	-
TOTAL RESOURCES	\$ 7,529	\$ 7,310	\$ 16,168	\$ 10,193	\$ 10,392	\$ 13,649	\$ 13,804	\$ 10,493	\$ 8,727	\$ 13,804
REQUIREMENTS										
PERSONNEL SERVICES										
Salaries	357	405	841	418	448	866	893	440	453	893
Benefits	206	244	523	247	260	507	554	274	280	554
TOTAL PERSONNEL SERVICES	563	649	1,364	665	708	1,373	1,447	714	733	1,447
MATERIALS & SERVICES										
Professional & Technical Services:										
Electricity - Street Lighting	258	266	540	306	260	566	540	270	270	540
Facility Repairs	76	104	260	86	100	186	260	130	130	260
Other	25	85	315	112	65	177	315	235	80	315
General Office Supplies	-	-	2	5	1	6	2	1	1	2
Education & Training	-	8	20	12	3	15	20	10	10	20
Operating Equipment	-	4	12	3	15	18	12	6	6	12
Miscellaneous Supplies	2	138	14	4	1	5	14	7	7	14
Self Insured Claims	-	-	2	-	-	-	2	1	1	2
TOTAL MATERIALS & SERVICES	361	605	1,165	528	445	973	1,165	660	505	1,165
Capital Outlay	1,068	1,941	6,577	652	673	1,325	6,683	2,391	4,292	6,683
Debt Service	441	142	626	391	393	784	786	393	393	786
Transfers to Other Funds	980	990	2,050	1,021	1,025	2,046	1,837	919	919	1,837
Contingency	-	-	750	-	-	-	34	-	34	34
TOTAL PROGRAM REQUIREMENTS	3,413	4,327	12,532	3,257	3,244	6,501	11,952	5,077	6,876	11,952
Unappropriated Ending Fund Balance	4,116	2,877	3,636	6,936	7,148	7,148	1,851	5,416	1,851	1,851
TOTAL REQUIREMENTS	\$ 7,529	\$ 7,204	\$ 16,168	\$ 10,193	\$ 10,392	\$ 13,649	\$ 13,804	\$ 10,493	\$ 8,727	\$ 13,804

*Franchise fees to transportation relates to Ordinance 1905 passed in 2002 dedicating 8% of net revenues of water, wastewater, and stormwater (net of any debt service obligations) to help fund the transportation system (Municipal Code Section 3.10)



RS272

SYSTEM DEVELOPMENT CHARGES FUND

TRANSPORTATION, WATER, WASTEWATER AND STORMWATER

DEPARTMENT DESCRIPTION AND CORE SERVICES

The Systems Development Charges (SDC) Fund accurately determines and collects applicable charges from new development, determines projects eligible for SDC and facilitates construction identified within approved capital improvement plans to further the development of the city by increasing capacity of the transportation and utility systems. SDC fees are determined in accordance with approved master plans and capital improvement plans for the respective utilities.

Below are the functions of the SDC Fund:

- Determine and collect applicable charges when properties develop or redevelop as reimbursement to the city for value of the existing facilities capacity available for growth
- Collect proportionate cost share for planned capacity improvements to be used for growth
- Distribute funds collected to construct improvements in system capacity necessary for growth or the betterment of the transportation and utility systems

ACCOMPLISHMENTS BN 2023-2024

- Completed Water and Wastewater System Plans
- Updated Wastewater SDC methodology
- Completed Water SDC methodology
- Constructed a cycle track adjacent to Monroe Street & 37th Avenue for Monroe Apartments site

PRIORITIES BN 2025-2026



Complete updates to Stormwater System Plan



Update the Transportation System Plan



Update Transportation SDC methodology

PERFORMANCE MEASURES

Value	Metric	FY 2021	FY 2022	FY 2023	Estimated		
					FY 2024	FY 2025	FY 2026
Accountable	\$ of SDC funds collected with new development (in thousands)	244	669	333	1,296	1,458	367
	\$ amount of SDC funds expended on projects (in thousands)	280	94	124	350	845	185
	# of SDC rates adjusted for inflation and updated for single family homes	18,538	18,725	19,508	19,811	20,306	20,813

FINANCIAL SUMMARY – SYSTEM DEVELOPMENT CHARGES FUND

(Amounts in Thousands: \$100 = \$100,000)

	HISTORICAL		BN 2023-2024 CURRENT OUTLOOK				BN 2025-2026			
	Actual FY 2021	Actual FY 2022	Amended Budget	Actual FY 2023	Estimated FY 2024	Estimated BN Total	Proposed Total	Approved FY 2025	Approved FY 2026	Approved Total
RESOURCES										
BEGINNING FUND BALANCE	\$ 1,775	\$ 1,700	\$ 2,299	\$ 2,277	\$ 2,485	\$ 2,277	\$ 2,937	\$ 2,937	\$ 3,357	\$ 2,937
System Development Charges	171	651	1,396	262	1,101	1,363	1,267	1,051	216	1,267
Intergovernmental	-	-	250	-	-	-	250	250	-	250
Interest Income	11	18	10	71	2	73	208	114	94	208
Transfers In	23	-	-	-	-	-	-	-	-	-
TOTAL RESOURCES	\$ 1,980	\$ 2,369	\$ 3,955	\$ 2,610	\$ 3,588	\$ 3,713	\$ 4,662	\$ 4,352	\$ 3,667	\$ 4,662
REQUIREMENTS										
Materials & Services	-	13	-	11	-	11	85	50	35	85
Capital Outlay	280	79	1,939	114	651	765	1,130	945	185	1,130
Contingency	-	-	260	-	-	-	-	-	-	-
TOTAL PROGRAM REQUIREMENTS	280	92	2,199	125	651	765	1,215	995	220	1,215
Unappropriated Ending Fund Balance	1,700	2,277	1,756	2,485	2,937	2,948	3,447	3,357	3,447	3,447
TOTAL REQUIREMENTS	\$ 1,980	\$ 2,369	\$ 3,955	\$ 2,610	\$ 3,588	\$ 3,713	\$ 4,662	\$ 4,352	\$ 3,667	\$ 4,662

	Actual FY 2021	Actual FY 2022	Amended Budget	Actual FY 2023	Estimated FY 2024	Estimated BN Total	Proposed Total	Approved FY 2025	Approved FY 2026	Approved Total
POLICY REQUIREMENTS										
Contingency & Ending Fund Balance Above Policy Requirement (25%)	1,700	2,277	2,016	2,485	2,937	2,948	3,447	3,357	3,447	3,447
	-	3	-	3	-	-	21	13	9	21
AMOUNT OVER (UNDER) POLICY REQUIREMENT	\$ 1,700	\$ 2,274	\$ 2,016	\$ 2,482	\$ 2,937	\$ 2,948	\$ 3,426	\$ 3,344	\$ 3,438	\$ 3,426

THE SYSTEMS DEVELOPMENT CHARGES FUND SUMMARY COMBINES THE FOLLOWING FUND SUMMARIES:

FINANCIAL SUMMARY – TRANSPORTATION SDC

(Amounts in Thousands: \$100 = \$100,000)

	HISTORICAL		BN 2023-2024 CURRENT OUTLOOK				BN 2025-2026			
	Actual FY 2021	Actual FY 2022	Amended Budget	Actual FY 2023	Estimated FY 2024	Estimated BN Total	Proposed Total	Approved FY 2025	Approved FY 2026	Approved Total
RESOURCES										
BEGINNING BALANCE	\$ 625	\$ 668	\$ 724	\$ 865	\$ 983	\$ 865	\$ 739	\$ 739	\$ 1,132	\$ 739
System Development Charges	88	193	905	214	187	401	757	643	114	757
Intergovernmental	-	-	250	-	-	-	250	250	-	250
Interest Income	3	4	2	18	-	18	100	50	50	100
Transfers In	14	-	-	-	-	-	-	-	-	-
TOTAL RESOURCES	\$ 730	\$ 865	\$ 1,881	\$ 1,097	\$ 1,170	\$ 1,284	\$ 1,846	\$ 1,682	\$ 1,296	\$ 1,846
REQUIREMENTS										
Materials & Services	-	3	150	3	-	3	50	50	-	50
Capital Outlay	62	-	1,040	114	431	545	500	500	-	500
Contingency	-	-	120	-	-	-	-	-	-	-
TOTAL PROGRAM REQUIREMENTS	62	-	1,160	114	431	545	500	500	-	500
Unappropriated Ending Balance	668	865	721	983	739	739	1,346	1,182	1,296	1,346
TOTAL REQUIREMENTS	\$ 730	\$ 865	\$ 1,881	\$ 1,097	\$ 1,170	\$ 1,284	\$ 1,846	\$ 1,682	\$ 1,296	\$ 1,846

FINANCIAL SUMMARY – WATER SDC

(Amounts in Thousands: \$100 = \$100,000)

	HISTORICAL		BN 2023-2024 CURRENT OUTLOOK				BN 2025-2026			
	Actual FY 2021	Actual FY 2022	Amended Budget	Actual FY 2023	Estimated FY 2024	Estimated BN Total	Proposed Total	Approved FY 2025	Approved FY 2026	Approved Total
RESOURCES										
BEGINNING BALANCE	\$ 175	\$ 87	\$ 197	\$ 119	\$ 143	\$ 119	\$ 298	\$ 298	\$ 531	\$ 298
System Development Charges	17	76	166	9	155	164	272	204	68	272
Interest Income	3	2	2	18	-	18	38	29	9	38
TOTAL RESOURCES	\$ 195	\$ 168	\$ 365	\$ 146	\$ 298	\$ 301	\$ 608	\$ 531	\$ 608	\$ 608
REQUIREMENTS										
Materials & Services	-	4	50	3	-	3	-	-	-	-
Capital Outlay	108	45	-	-	-	-	-	-	-	-
Contingency	-	-	10	-	-	-	-	-	-	-
TOTAL PROGRAM REQUIREMENTS	108	49	60	3	-	3	-	-	-	-
Unappropriated Ending Balance	87	119	305	143	298	298	608	531	608	608
TOTAL REQUIREMENTS	\$ 195	\$ 168	\$ 365	\$ 146	\$ 298	\$ 301	\$ 608	\$ 531	\$ 608	\$ 608

FINANCIAL SUMMARY – WASTEWATER SDC

(Amounts in Thousands: \$100 = \$100,000)

	HISTORICAL		BN 2023-2024 CURRENT OUTLOOK				BN 2025-2026			
	Actual FY 2021	Actual FY 2022	Amended Budget	Actual FY 2023	Estimated FY 2024	Estimated BN Total	Proposed Total	Approved FY 2025	Approved FY 2026	Approved Total
RESOURCES										
BEGINNING BALANCE	\$ 775	\$ 707	\$ 889	\$ 945	\$ 934	\$ 945	\$ 1,205	\$ 1,205	\$ 1,102	\$ 1,205
System Development Charges	30	270	62	(27)	490	463	48	32	16	48
Interest Income	3	2	4	18	1	19	70	35	35	70
Miscellaneous	-	3	-	-	-	-	-	-	-	-
Transfers In	9	-	-	-	-	-	-	-	-	-
TOTAL RESOURCES	\$ 817	\$ 982	\$ 955	\$ 936	\$ 1,425	\$ 1,427	\$ 1,323	\$ 1,272	\$ 1,153	\$ 1,323
REQUIREMENTS										
Materials & Services	-	3	-	2	-	2	-	-	-	-
Capital Outlay	110	34	170	-	220	220	320	170	150	320
Contingency	-	-	-	-	-	-	-	-	-	-
TOTAL PROGRAM REQUIREMENTS	110	37	170	2	220	222	320	170	150	320
Unappropriated Ending Balance	707	945	785	934	1,205	1,205	1,003	1,102	1,003	1,003
TOTAL REQUIREMENTS	\$ 817	\$ 982	\$ 955	\$ 936	\$ 1,425	\$ 1,427	\$ 1,323	\$ 1,272	\$ 1,153	\$ 1,323

FINANCIAL SUMMARY – STORMWATER SDC

(Amounts in Thousands: \$100 = \$100,000)

	HISTORICAL		BN 2023-2024 CURRENT OUTLOOK				BN 2025-2026			
	Actual FY 2021	Actual FY 2022	Amended Budget	Actual FY 2023	Estimated FY 2024	Estimated BN Total	Proposed Total	Approved FY 2025	Approved FY 2026	Approved Total
RESOURCES										
BEGINNING BALANCE	\$ 200	\$ 238	\$ 489	\$ 352	\$ 432	\$ 352	\$ 702	\$ 702	\$ 599	\$ 702
System Development Charges	36	112	263	66	269	335	190	172	18	190
Interest Income	2	2	2	17	1	18	-	-	-	-
Miscellaneous	-	3	-	-	-	-	-	-	-	-
TOTAL RESOURCES	\$ 238	\$ 355	\$ 754	\$ 435	\$ 702	\$ 705	\$ 892	\$ 874	\$ 617	\$ 892
REQUIREMENTS										
Materials & Services	-	3	350	3	-	3	35	-	35	35
Capital Outlay	-	-	350	-	-	-	310	275	35	310
Contingency	-	-	-	-	-	-	-	-	-	-
TOTAL PROGRAM REQUIREMENTS	-	3	700	3	-	3	345	275	70	345
Unappropriated Ending Balance	238	352	54	432	702	702	547	599	547	547
TOTAL REQUIREMENTS	\$ 238	\$ 355	\$ 754	\$ 435	\$ 702	\$ 705	\$ 892	\$ 874	\$ 617	\$ 892



WATER FUND

DEPARTMENT DESCRIPTION AND CORE SERVICES

The Water Department provides residents with potable water for public health and fire response, as well as ensuring an adequate supply is available for essential daily needs. The department is responsible for compliance with state and federal regulations and with the Safe Drinking Water Act.

Milwaukie draws its water from the Troutdale Gravels Aquifer through intricate well systems and technologies. This underground water supply stretches from north of Vancouver, Washington to south of Milwaukie and is bounded by the Willamette River on the west and the base of the Cascades on the east. Milwaukie's water infrastructure has a storage capacity of six million gallons of water and can produce in excess of six million gallons of water per day through a network of continuously monitored wells, treatment plants, pump stations and piping. Emergency interties, which are water pipe connections between jurisdictional water systems, are maintained with connections to the City of Portland and Clackamas River Water for resiliency and emergency preparedness.

The department's core services include:

- Providing city residents with water that meets or exceeds all federal and state water quality requirements. More information can be found in the annual water quality report on the city's website: <https://www.milwaukieoregon.gov/WQR>.
- Maintaining water system infrastructure
- Remaining current with changing technology, rules and regulations through education and training efforts
- Preserving over 100 miles of waterline, 6,911 services, 964 fire hydrants, seven wells, three storage reservoirs, and four pump stations

ACCOMPLISHMENTS BN 2023-2024

- Began construction on Stanley Reservoir to rehabilitate the interior and exterior of the reservoir and provide safety improvements to remedy seismic and cathodic deficiencies
- Started a lead service lines inventory to comply with the U.S. Environmental Protection Agency's Lead and Copper Rule Revisions to prevent drinking water contamination
- Established engineering service contracts to begin development of plans for future water treatment plant upgrades and other water-related capital projects
- Upgraded control systems at the Lava Pump Station and Well #7

PRIORITIES BN 2025-2026



Complete upgrades to the Supervisory Control and Data Acquisition (SCADA) system and infrastructure to improve the city's ability to monitor and control water availability and distribution throughout the community



Increase maintenance and repairs at treatment plants and well sites to improve asset resiliency and efficiency and prolong the lifespan of water infrastructure



Research and identify energy efficient projects for the water system to reduce the utility's overall carbon footprint

PRIORITIES BN 2025-2026 (CONTINUED)



Rehabilitate the concrete reservoir at 40th and Harvey by replacing the interior liner and providing seismic improvements



Begin planning and design process for future treatment plant upgrades that incorporate new regulatory requirements



Complete lead service line inventory and make the inventory accessible to the community

PERFORMANCE MEASUREMENTS

Value	Metric	FY 2021	FY 2022	FY 2023	Estimated		
					FY 2024	FY 2025	FY 2026
Efficient	# of meters replaced when needed	23	1	3	4	15	15
	# of water service lines repaired	7	11	5	10	10	10
	# of water main breaks repaired	6	5	2	6	5	5
	# of service orders for utility billing	2,121	1,732	1,417	1,400	1,700	1,700
Accountable	% of hydrants maintained	11%	41%	17%	20%	20%	20%



FINANCIAL SUMMARY – WATER FUND

(Amounts in Thousands: \$100 = \$100,000)

	HISTORICAL		BN 2023-2024 CURRENT OUTLOOK				BN 2025-2026			
	Actual FY 2021	Actual FY 2022	Amended Budget	Actual FY 2023	Estimated FY 2024	Estimated BN Total	Proposed Total	Approved FY 2025	Approved FY 2026	Approved Total
RESOURCES										
BEGINNING FUND BALANCE	\$ 4,630	\$ 4,546	\$ 7,359	\$ 5,395	\$ 6,717	\$ 5,395	\$ 6,136	\$ 6,136	\$ 3,782	\$ 6,136
Fees & Charges	4,471	4,366	10,209	4,691	5,045	9,736	10,556	5,201	5,355	10,556
Reimbursement Fees	20	91	200	11	43	54	272	204	68	272
Intergovernmental - ARPA	-	-	2,256	-	-	-	-	-	-	-
Intergovernmental - Other	-	9	-	-	-	-	3,695	3,695	-	3,695
Interest Income	2	16	40	279	300	579	195	120	75	195
Miscellaneous	90	62	74	15	36	51	38	19	19	38
TOTAL RESOURCES	\$ 9,213	\$ 9,090	\$ 20,138	\$ 10,391	\$ 12,141	\$ 15,815	\$ 20,892	\$ 15,375	\$ 9,299	\$ 20,892
REQUIREMENTS										
PERSONNEL SERVICES										
Salaries	549	568	1,223	599	575	1,174	1,403	691	712	1,403
Benefits	324	339	749	347	342	689	883	437	446	883
TOTAL PERSONNEL SERVICES	873	907	1,972	946	917	1,863	2,286	1,128	1,158	2,286
MATERIALS & SERVICES										
Professional & Technical Services										
Compliance Obligations	71	45	350	125	270	395	315	150	165	315
Electricity	204	210	440	223	242	465	500	250	250	500
Facility Repairs	183	200	440	174	140	314	440	220	220	440
Other	38	39	65	-	-	-	70	35	35	70
General Office Supplies	3	5	8	4	3	7	8	4	4	8
Dues & Subscriptions	14	13	32	13	16	29	32	16	16	32
Education & Training	3	6	20	11	4	15	20	10	10	20
Fees & Licenses	4	13	24	16	16	32	24	12	12	24
Franchise Fees to Transportation*	321	340	817	402	414	816	835	411	424	835
Operating Equipment	15	14	80	11	15	26	80	40	40	80
Miscellaneous Supplies	6	7	8	4	6	10	8	4	4	8
Rents & Leases	6	7	14	8	7	15	14	7	7	14
Self Insured Claims	-	-	2	-	-	-	2	1	1	2
Utility Assistance	-	-	13	7	-	7	14	7	7	14
Bad Debt	58	134	120	-	-	-	60	30	30	60
TOTAL MATERIALS & SERVICES	926	1,033	2,433	998	1,133	2,131	2,422	1,197	1,225	2,422
Capital Outlay	1,588	416	7,371	156	2,375	2,531	10,287	7,714	2,573	10,287
Transfers to Other Funds	1,280	1,340	3,160	1,574	1,580	3,154	3,108	1,554	1,554	3,108
Contingency	-	-	650	-	-	-	56	-	56	56
TOTAL PROGRAM REQUIREMENTS	4,667	3,696	15,586	3,674	6,005	9,679	18,159	11,593	6,566	18,159
Unappropriated Ending Fund Balance	4,546	5,394	4,552	6,717	6,136	6,136	2,733	3,782	2,733	2,733
TOTAL REQUIREMENTS	\$ 9,213	\$ 9,090	\$ 20,138	\$ 10,391	\$ 12,141	\$ 15,815	\$ 20,892	\$ 15,375	\$ 9,299	\$ 20,892

*Franchise fees to transportation are from the utility funds dedicating 8% of net revenues per the Municipal Code Section 3.10 passed by Ordinance # 1905 in 2002.

	Actual FY 2021	Actual FY 2022	Amended Budget	Actual FY 2023	Estimated FY 2024	Estimated BN Total	Proposed Total	Approved FY 2025	Approved FY 2026	Approved Total
BUDGETED POSITIONS										
Full-Time Equivalent (FTE) Employee #	8.2	8.2	8.0	8.0	8.0	8.0	9.0	9.0	9.0	9.0
Population	20,556	20,600	20,600	21,235	21,235	21,235	21,341	21,341	21,341	21,341
MONTHLY OPERATING COSTS PER CAPITA	\$ 12	\$ 13	\$ 31	\$ 14	\$ 14	\$ 28	\$ 31	\$ 15	\$ 15	\$ 31
POLICY REQUIREMENTS										
Contingency & Ending Fund Balance Above	4,546	5,394	5,202	6,717	6,136	6,136	2,789	3,782	2,789	2,789
Policy Requirement (50%)	1,540	1,640	3,780	1,760	1,820	3,570	1,970	1,940	1,970	1,970
AMOUNT OVER (UNDER) POLICY REQUIREMENT	\$ 3,006	\$ 3,754	\$ 1,422	\$ 4,957	\$ 4,316	\$ 2,566	\$ 819	\$ 1,842	\$ 819	\$ 819



RS280

WASTEWATER FUND

DEPARTMENT DESCRIPTION AND CORE SERVICES

The Wastewater Department provides effective management and financing of the wastewater collections system within the public right-of-way. The department provides wastewater collection, pumping and revenue collection for treatment services for Milwaukie residents, while protecting environmental quality and eliminating sanitary sewer overflows.

Wastewater is carried into the city's sanitary sewer system from homes, schools, and other buildings for safe and effective disposal. Small pipes carry wastewater from buildings into sewer pipes and sewer mains placed under streets, and by gravity and a series of sewer lift stations, the vast majority of wastewater flows into the Kellogg Wastewater Treatment Plant which is operated by Clackamas County Sewer District #1. The Wastewater Department also contracts for treatment services with the City of Portland and Oak Lodge Water District for the few properties within those sewer systems. After treatment for bacteria, particulates, and temperature, the water is released into the Willamette River as clean water that meets state and federal guidelines for surface water health.

The Wastewater Department's main functions are:

- Operate and maintain wastewater collections infrastructure efficiently and at minimal cost to residents
- Provide environmental services to oversee and enforce the Fats, Oils and Grease (FOG) program to help eliminate the amount of materials in the wastewater collections system
- Maintain 79 miles of public sanitary sewers, five sewer lift stations, and 1,692 manholes

ACCOMPLISHMENTS BN 2023-2024

- Conducted a study for the Waverly Heights Sewer System Reconfiguration project by gathering information on manhole depths and closed-circuit (CCTV) mainlines
- Inspected approximately 26% of the system and removed roots from sewer mainlines
- Collaborated with the Engineering Department to gather information on utility locations and condition assessments for capital projects
- Installed four pipe patch repairs to fix inflow and infiltration concerns
- Investigated restaurants not in compliance with the FOG program and enforced installation of more effective grease interceptors to reduce sewer backups and discharges to the city's sewer main
- Continued to enhance FOG program through cooperation with local municipalities and preferred pumpers
- Provided prompt response to lift station failures that prevented backups or overflow
- Ongoing collaboration with the Information Technology and Engineering departments and contractors for upgrades to the Supervisory Control and Data Acquisition (SCADA) system
- Co-purchased a new electric truck with the Stormwater Department to reduce emissions and fuel costs

PRIORITIES BN 2025-2026

- 

Provide quality customer service through responsive site visits and communications and creating a safe and enjoyable work environment for employees by meeting all state and federal standards
- 

Research and identify energy efficiency projects for wastewater collection system to reduce the utility's overall carbon footprint to meet Milwaukie's goal of carbon neutrality by 2045
- 

Prevent mainline blockages and sanitary sewer overflows by completing routine maintenance, cleaning, and CCTV inspections in accordance with asset management guidelines
- 

Expand department staff expertise and knowledge through trainings, workshops, and certification programs aligned with city needs and goals, including climate resiliency
- 

Complete upgrades to SCADA system and infrastructure to improve the city's ability to monitor and control wastewater collection

PERFORMANCE MEASURES

Value	Metric	FY 2021	FY 2022	FY 2023	Estimated		
					FY 2024	FY 2025	FY 2026
Efficient	# of linear feet hydro cleaning performed in the mainline	68,056	89,069	105,193	106,000	110,000	110,000
	# of manhole inspections	43	328	435	460	500	500
	# of linear feet mainline inspections with TV equipment	75,366	90,000	110,000	110,000	110,000	110,000
	# of lift station inspections	440	530	462	500	550	550



FINANCIAL SUMMARY – WASTEWATER FUND

(Amounts in Thousands: \$100 = \$100,000)

	HISTORICAL		BN 2023-2024 CURRENT OUTLOOK				BN 2025-2026			
	Actual FY 2021	Actual FY 2022	Amended Budget	Actual FY 2023	Estimated FY 2024	Estimated BN Total	Proposed Total	Approved FY 2025	Approved FY 2026	Approved Total
RESOURCES										
BEGINNING FUND BALANCE	\$ 5,525	\$ 5,454	\$ 6,294	\$ 5,664	\$ 5,733	\$ 5,664	\$ 4,654	\$ 4,654	\$ 2,602	\$ 4,654
Fees & Charges	8,070	8,352	17,859	8,751	9,089	17,840	18,490	9,279	9,211	18,490
Proceeds from Reimbursement District	43	165	86	190	25	215	86	43	43	86
Intergovernmental:										
ARPA Funds	-	-	-	132	-	132	-	-	-	-
Good Neighbor	-	-	608	-	-	-	-	-	-	-
Other	-	5	1,125	-	-	-	2,479	1,762	717	2,479
Interest Income	15	23	50	239	140	379	175	100	75	175
Miscellaneous	4	29	26	4	7	11	28	14	14	28
Transfers In	49	-	-	-	-	-	-	-	-	-
TOTAL RESOURCES	\$ 13,706	\$ 14,028	\$ 26,048	\$ 14,980	\$ 14,994	\$ 24,241	\$ 25,912	\$ 15,852	\$ 12,662	\$ 25,912
REQUIREMENTS										
PERSONNEL SERVICES										
Salaries	289	336	700	346	356	702	727	358	369	727
Benefits	159	170	392	190	201	391	455	225	230	455
TOTAL PERSONNEL SERVICES	448	506	1,092	536	557	1,093	1,182	583	599	1,182
MATERIALS & SERVICES										
Professional & Technical Services:										
Electricity	10	13	31	12	11	23	36	18	18	36
Facility Repairs	43	49	150	45	45	90	150	75	75	150
Good Neighbor	-	-	150	-	-	-	-	-	-	-
Other	12	2	126	8	20	28	171	73	98	171
Wastewater Treatment Costs	5,199	5,147	11,215	5,246	5,210	10,456	10,850	5,400	5,450	10,850
General Office Supplies	-	-	2	-	1	1	2	1	1	2
Dues & Subscriptions	1	1	4	-	1	1	4	2	2	4
Education & Training	1	8	24	14	15	29	12	12	-	12
Franchise Fees to Transportation*	173	197	532	269	262	531	611	310	301	611
Operating Equipment	-	4	20	2	10	12	-	-	-	-
Miscellaneous Supplies	5	8	4	6	6	12	6	3	3	6
Rents & Leases	-	-	15	-	-	-	16	8	8	16
Self Insured Claims	-	-	1	-	-	-	2	1	1	2
Utility Assistance	-	-	11	7	-	7	14	7	7	14
Bad Debt	93	155	85	-	30	30	70	35	35	70
TOTAL MATERIALS & SERVICES	5,537	5,584	12,370	5,609	5,611	11,220	11,944	5,945	5,999	11,944
Construction in Progress	886	843	5,314	1,546	2,521	4,067	6,725	5,080	1,645	6,725
Debt Service	101	101	202	101	191	292	384	191	193	384
Transfers to Other Funds	1,280	1,330	2,920	1,455	1,460	2,915	2,902	1,451	1,451	2,902
Contingency	-	-	1,030	-	-	-	34	-	34	34
TOTAL PROGRAM REQUIREMENTS	8,252	8,364	22,928	9,247	10,340	19,587	23,171	13,250	9,921	23,171
Unappropriated Ending Fund Balance	5,454	5,664	3,120	5,733	4,654	4,654	2,741	2,602	2,741	2,741
TOTAL REQUIREMENTS	\$ 13,706	\$ 14,028	\$ 26,048	\$ 14,980	\$ 14,994	\$ 24,241	\$ 25,912	\$ 15,852	\$ 12,662	\$ 25,912

*Franchise fees to transportation are from the utility funds dedicating 8% of net revenues per the Municipal Code Section 3.10 passed by Ordinance #1905 in 2002.

BUDGETED POSITIONS	Actual FY 2021	Actual FY 2022	Amended Budget	Actual FY 2023	Estimated FY 2024	Estimated BN Total	Proposed Total	Approved FY 2025	Approved FY 2026	Approved Total
Full-Time Equivalent (FTE) Employee #	5.0	5.0	4.5	4.5	4.5	4.5	4.5	4.5	4.5	4.5
Population	20,556	20,600	20,600	21,235	21,235	21,235	21,341	21,341	21,341	21,341
MONTHLY OPERATING COSTS PER CAPITA	\$ 29	\$ 9	\$ 33	\$ 12	\$ 16	\$ 27	\$ 38	\$ 26	\$ 12	\$ 38
POLICY REQUIREMENTS										
Contingency & Ending Fund Balance Above	5,454	5,664	4,150	5,733	4,654	4,654	2,775	2,602	2,775	2,775
Policy Requirement (25%)	1,840	1,880	4,150	1,930	1,950	3,880	2,060	2,040	2,060	2,060
AMOUNT OVER (UNDER) POLICY REQUIREMENT	\$ 3,614	\$ 3,784	\$ 0	\$ 3,803	\$ 2,704	\$ 774	\$ 715	\$ 562	\$ 715	\$ 715



RS284

STORMWATER FUND

DEPARTMENT DESCRIPTION AND CORE SERVICES

The Stormwater Department provides effective management and financing of the stormwater system within the city's public right-of-way. The department protects the health, safety and welfare of the public by providing safe, efficient capture and conveyance of stormwater runoff which in turn promotes healthy surface water systems.

The Stormwater Department is also responsible for management of natural resource efforts to align with the city's climate and urban forest goals, including green infrastructure, trees, and vegetation in the right-of-way. Milwaukie has a natural topography that includes areas of low land without natural drainage, resulting in reliance on infiltration (the seepage of surface water through soil) to drain stormwater. These areas experience flooding issues during heavy rain events and have a higher need for new infrastructure and replacement of underground structures that assist in infiltration due to the prevalence in the area and failure susceptibility.

The department was issued a National Pollutant Discharge Elimination System (NPDES) permit by the Oregon Department of Environmental Quality (DEQ) which contains requirements to minimize impacts from pollutants carried into area streams, rivers and wetlands via the stormwater system. The city's permit is for a stormwater system separate from the wastewater system, known as a Municipal Separated Storm Sewer System (MS4). The department continues to meet increased requirements around maintenance, water quality sampling, and treatment of new and existing stormwater facilities. The department's core services include:

- Design, construct, maintain, inspect, and enforce stormwater rules and regulations
- Perform general maintenance and sweep city streets in compliance with NPDES permit
- Permit the Water Pollution Control Facility (WPCF) and storm system in general
- Permit for Underground Injection Control components such as drywells
- Provide ongoing education for employees to keep current with the evolving technology, rules, and regulations
- Maintain 41 miles of storm mainlines, 1,603 catch basins, 210 drywells, 122 sedimentation manholes, 539 manholes, five detention ponds, and 46 rain gardens

ACCOMPLISHMENTS BN 2023-2024

- Swept 1,300 lane miles of streets and cleaned over 2.4 miles of storm water
- Updated and implemented a new Stormwater Management Plan in accordance with the city's stormwater NPDES permit
- Created an online reference library of relevant stormwater compliance documents
- Began construction on the second phase of the Meek Street Stormwater Pipeline project
- Initiated process to update the Stormwater System Plan
- Completed annual reports in compliance with NPDES permit and maintained compliance with WPCF permit
- Achieved the eighth year of Tree City USA certification and a fifth Tree City Growth Award from the Arbor Day Foundation
- Collaborated with DEQ on issuance a new NPDES MS4 permit to better align with stormwater goals and practices

ACCOMPLISHMENTS BN 2023-2024 (CONTINUED)

- Installed a new manhole at the city's public works campus
- Repaired various stormwater pipes damaged by roots
- Conducted five spill responses and illicit discharge investigations and four sinkhole investigations
- Co-purchased new electric truck with Wastewater Department to reduce emissions and fuel costs

PRIORITIES BN 2025-2026



Comply with DEQ regulations listed in permits, management plans and monitoring plans, including implementation of updated NPDES MS4 permit and stormwater management plan and updates to erosion control code to implement escalating enforcement requirements



Improve riparian habitat restoration and stormwater management on private property utilizing programs for restoration efforts and green infrastructure



Evaluate and prepare for future changes to the total maximum daily load regulations



Continue to lead by example in dewatering practices at the city's decant facility



Strategically plant, preserve, and manage trees in the community's urban forest to maximize the important role trees play in stormwater management



Expand department staff expertise and knowledge through trainings, workshops, and certification programs aligned with city needs, including climate resiliency



Evaluate tree and shrub species that may better adapt to future climates



Address potential known flood areas through capital improvement projects



Complete updates to the Stormwater System Plan

PERFORMANCE MEASURES

Value	Metric	FY 2021	FY 2022	FY 2023	Estimated		
					FY 2024	FY 2025	FY 2026
Accountable	# of dry wells cleaned as required by state statute	16	4	24	24	24	24
	# of responses related to environmental spills	7	6	9	10	10	10
Efficient	# of catch basins cleaned	822	836	806	850	850	850
	# of feet of mainline cleaning	11,313	38,411	50,778	55,000	60,000	65,000
	# of feet inspected by TV monitoring	50,992	38,055	21,467	30,000	35,000	40,000
	# of rain bioswales maintained	264	418	357	360	360	360
	# of inspections for erosion control	194	516	285	300	300	300
	# of miles of streets swept to clear debris	1,266	1,274	1,095	1,300	1,300	1,300

FINANCIAL SUMMARY – STORMWATER FUND

(Amounts in Thousands: \$100 = \$100,000)

	HISTORICAL		BN 2023-2024 CURRENT OUTLOOK				BN 2025-2026			
	Actual FY 2021	Actual FY 2022	Amended Budget	Actual FY 2023	Estimated FY 2024	Estimated BN Total	Proposed Total	Approved FY 2025	Approved FY 2026	Approved Total
RESOURCES										
BEGINNING FUND BALANCE	\$ 5,132	\$ 6,090	\$ 7,278	\$ 7,056	\$ 8,940	\$ 7,056	\$ 7,707	\$ 7,707	\$ 1,633	\$ 7,707
Fees & Charges	5,118	5,200	10,611	5,151	5,185	10,336	10,473	5,222	5,251	10,473
Intergovernmental	308	61	585	-	585	585	-	-	-	-
Interest Income	25	22	30	262	275	537	120	60	60	120
Miscellaneous	33	45	60	83	17	100	34	17	17	34
Transfers In	56	-	-	-	-	-	-	-	-	-
TOTAL RESOURCES	\$ 10,672	\$ 11,418	\$ 18,564	\$ 12,552	\$ 15,002	\$ 18,614	\$ 18,334	\$ 13,006	\$ 6,961	\$ 18,334
REQUIREMENTS										
PERSONNEL SERVICES										
Salaries	487	487	1,096	477	524	1,001	1,151	567	584	1,151
Benefits	214	257	607	264	280	544	628	310	318	628
TOTAL PERSONNEL SERVICES	701	744	1,703	741	804	1,545	1,779	877	902	1,779
MATERIALS & SERVICES										
Professional & Technical Services										
Facility Repairs	89	103	222	125	100	225	230	115	115	230
Refuse	-	27	50	36	35	71	70	35	35	70
Stormwater monitoring	-	-	-	-	-	-	50	25	25	50
Other	103	156	274	85	122	207	241	117	124	241
General Office Supplies	-	3	2	1	1	2	-	-	-	-
Fees & Licenses	-	8	6	2	7	9	16	8	8	16
Dues & Subscriptions	8	1	12	1	1	2	10	5	5	10
Education & Training	2	15	10	26	26	52	30	15	15	30
Franchise Fees to Transportation*	398	395	849	423	426	849	830	414	416	830
Operating Equipment	-	-	50	2	2	4	36	18	18	36
Miscellaneous Supplies	3	24	4	15	14	29	8	4	4	8
Rents & Leases	-	1	4	-	-	-	3	2	1	3
Self Insured Claims	-	-	10	-	-	-	10	5	5	10
Utility Assistance	-	-	10	6	6	12	10	5	5	10
Bad Debt	57	135	70	-	-	-	50	25	25	50
TOTAL MATERIALS & SERVICES	660	868	1,573	722	740	1,462	1,594	793	801	1,594
Construction In Progress	1,861	1,330	9,981	724	4,346	5,070	10,159	8,303	1,856	10,159
Transfers to Other Funds	1,360	1,420	2,810	1,425	1,405	2,830	2,800	1,400	1,400	2,800
Contingency	-	-	910	-	-	-	45	-	45	45
TOTAL PROGRAM REQUIREMENTS	4,582	4,362	16,977	3,612	7,295	10,907	16,377	11,373	5,004	16,377
Unappropriated Ending Fund Balance	6,090	7,056	1,587	8,940	7,707	7,707	1,957	1,633	1,957	1,957
TOTAL REQUIREMENTS	\$ 10,672	\$ 11,418	\$ 18,564	\$ 12,552	\$ 15,002	\$ 18,614	\$ 18,334	\$ 13,006	\$ 6,961	\$ 18,334

*Franchise fees to transportation are from the utility funds dedicating 8% of net revenues per the Municipal Code Section 3.10 passed by Ordinance # 1905 in 2002.

	Actual FY 2021	Actual FY 2022	Amended Budget	Actual FY 2023	Estimated FY 2024	Estimated BN Total	Proposed Total	Approved FY 2025	Approved FY 2026	Approved Total
BUDGETED POSITIONS										
Full-Time Equivalent (FTE) Employee #	8.5	8.0	8.0	8.0	8.0	8.0	8.0	8.0	8.0	8.0
Population	20,556	20,600	20,600	21,235	21,235	21,235	21,341	21,341	21,341	21,341
MONTHLY OPERATING COSTS PER CAPITA	\$ 11	\$ 12	\$ 25	\$ 11	\$ 12	\$ 23	\$ 24	\$ 12	\$ 12	\$ 24
POLICY REQUIREMENTS										
Contingency & Ending Fund Balance Above	6,090	7,056	2,497	8,940	7,707	7,707	2,002	1,633	2,002	2,002
Policy Requirement (25%)	680	760	1,520	720	740	1,460	780	770	780	780
AMOUNT OVER (UNDER) POLICY REQUIREMENT	\$ 5,410	\$ 6,296	\$ 977	\$ 8,220	\$ 6,967	\$ 6,247	\$ 1,222	\$ 863	\$ 1,222	\$ 1,222



RS288

Five-Year Forecast

LONG TERM FINANCIAL PLANNING PROCESS

Planning for the future is critical to the effective management of the city. As such, the City of Milwaukie prepares a five-year financial forecast to assist with the strategic decision-making process and to identify and prepare for future challenges. A dynamic planning model is used to develop the baseline financial forecast which are then utilized to strategize and study various financial outcomes, modeling demographic trends, anticipating changes in revenue streams, and forecasting utility rates. The outcome of this forecasting exercise serves to guide decision-making in the interest of long-term financial stability.

Revenue forecasts are based on historical trends, current revenue policy, assumptions on future economic impacts, and known future occurrences. Similarly, expenditure forecasts are based on historical trends, current service levels, existing commitments, and other known future obligations. The major assumptions or percentages per revenue or expense are outlined in each fund table.

The city recently completed its Capital Improvement Plan (CIP), which is aligned with the financial forecast and this budget document. Corresponding to the CIP are master plan documents which provide long-range planning (20 years) for necessary capital improvements and investments in the city's infrastructure. This level of planning allows for thoughtful project management and financing. The biennial budget includes funds to prepare new or updated master plans and corresponding rate studies for transportation, wastewater and stormwater.

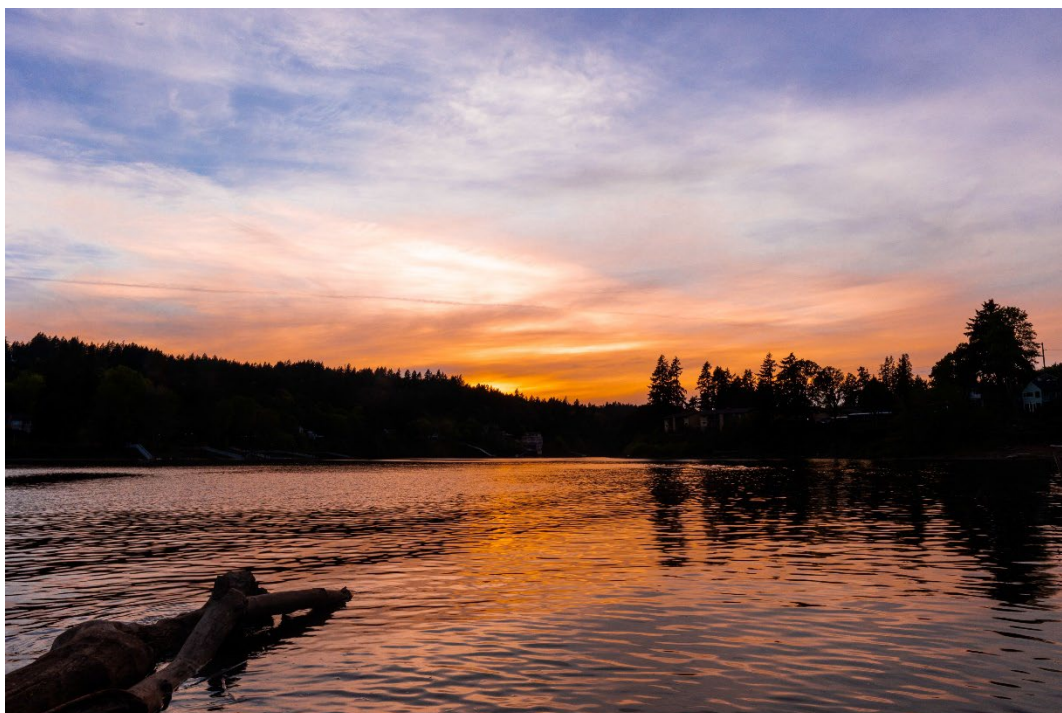

FIVE-YEAR FORECAST

GENERAL FUND SUMMARY

(Amounts in Thousands; \$ 00 = \$ 100,000)

	Current Fiscal Year Estimated FY 2024					ASSUMPTIONS						
	FY 2021	FY 2022	FY 2023	Current Budget +1 FY 2025	+2 FY 2026	+3 FY 2027	+4 FY 2028	+5 FY 2029				
RESOURCES												
BEGINNING FUND BALANCE	\$ 10,963	\$ 12,077	\$ 14,820	13,423	10,168	\$ 6,289	\$ 839	\$ (4,328)				
REVENUES												
Property Taxes	9,048	9,265	9,708	9,845	10,436	10,749	11,071	11,403	3%			
Franchise Taxes	2,452	2,257	2,447	2,227	3,527	3,810	4,114	4,443	8%			
Intergovernmental	3,268	2,982	3,721	-	2,999	3,089	3,182	3,277	3%			
Intergovernmental - ARPA	-	2,366	75	-	-	-	-	-	0%			
Fines & Forfeitures	417	362	459	409	430	443	456	470	3%			
Fees & Charges (Licenses & Permits)	569	646	594	436	500	515	530	546	3%			
Interest Income	70	108	356	548	250	250	250	250	0%			
Miscellaneous	55	169	317	-	-	-	-	-	0%			
Sale of Assets	39	60	6	287	20	21	21	22	3%			
Transfers from Other Funds	6,220	6,470	7,657	6,900	6,807	7,011	7,221	7,438	3%			
TOTAL REVENUES	22,138	24,685	25,340	20,652	24,969	25,887	26,846	27,850				
TOTAL RESOURCES	\$ 33,101	\$ 36,762	\$ 40,160	\$ 34,075	\$ 35,136	\$ 32,175	\$ 27,685	\$ 23,522				

Continued on next page.

GENERAL FUND SUMMARY, Continued

(Amounts in Thousands; \$ 100 = \$ 100,000)

	Current Fiscal Year Estimated FY 2024					Forecast					ASSUMPTIONS	
	FY 2021	FY 2022	FY 2023	FY 2024	FY 2025	+1 FY 2025	+2 FY 2026	+3 FY 2027	+4 FY 2028	+5 FY 2029		
REQUIREMENTS												
EXPENDITURES												
Personnel Services	15,323	15,741	16,665	17,138	18,810	19,299	20,648	21,474	22,332	22,332	Varies	
Materials & Services	4,398	5,299	5,579	5,679	6,385	6,500	6,706	6,919	7,139	7,139	3%	
Debt Service	461	481	505	571	504	526	546	569	594	594	Amortization Schedules	
Capital Outlay	478	422	1,976	1,318	2,820	472	745	300	290	290	Capital Improvement Plan	
Transfers to Other Funds	364	-	1,528	298	314	314	323	333	343	343	Debt Service for City Hall	
Contingency	-	-	-	-	-	1,737	2,368	2,420	2,474	2,474		
TOTAL EXPENDITURES	21,024	21,943	26,253	25,004	28,832	28,848	31,336	32,014	33,170	33,170		
FUND BALANCE												
Policy Requirement (25%)	4,374	4,566	5,252	5,188	4,555	5,803	6,840	7,100	7,370	7,370		
RESERVES												
ARPA Parks	-	-	-	-	1,124	-	-	-	-	-		
Debt Service	461	481	505	505	504	526	546	569	594	594		
Forfeiture	17	36	17	17	17	17	17	17	17	17		
PEG	169	177	169	69	177	182	182	182	182	182		
Undesignated	11,430	14,126	12,732	11,684	8,346	6,805	94	(5,096)	(10,442)	(10,442)		
OVER (UNDER) POLICY	7,056	9,560	7,480	6,496	3,791	2,739	(4,378)	(9,777)	(15,338)	(15,338)		
TOTAL ENDING FUND BALANCE	12,077	14,820	13,906	9,071	7,743	6,289	839	(4,328)	(9,649)	(9,649)		
TOTAL REQUIREMENTS	\$ 33,101	\$ 36,762	\$ 40,160	\$ 34,075	\$ 36,575	\$ 35,136	\$ 32,175	\$ 27,685	\$ 23,522	\$ 23,522		

FIVE-YEAR FORECAST

DEBT SERVICE FUND SUMMARY

(Amounts in Thousands: \$100 = \$100,000)

	(Amounts in Thousands: \$100 = \$100,000)					ASSUMPTIONS			
	FY 2021	FY 2022	FY 2023	Current Fiscal Year Estimated FY 2024	Current Budget +1 FY 2025 +2 FY 2026		+3 FY 2027	Forecast +4 FY 2028	+5 FY 2029
RESOURCES									
BEGINNING FUND BALANCE	\$ 360	\$ 442	\$ 9	243	53	58	63	62	58
REVENUES									
Property Taxes	862	856	860	859	854	860	854	858	858
Intergovernmental	85	83	168	-	85	87	85	85	85
Miscellaneous	6	2	24	16	5	5	-	-	-
Transfers from Other Funds	504	-	560	308	432	433	432	433	432
TOTAL REVENUES	1,457	941	1,612	1,183	1,376	1,385	1,371	1,376	1,375
TOTAL RESOURCES	\$ 1,817	\$ 1,383	\$ 1,621	\$ 1,426	\$ 1,429	\$ 1,443	\$ 1,434	\$ 1,438	\$ 1,433
REQUIREMENTS									
EXPENDITURES									
Debt Service	1,375	1,374	1,378	1,373	1,371	1,380	1,372	1,380	1,373
TOTAL EXPENDITURES	1,375	1,374	1,378	1,373	1,371	1,380	1,372	1,380	1,373
TOTAL ENDING FUND BALANCE	442	9	243	53	58	63	62	58	60
TOTAL REQUIREMENTS	\$ 1,817	\$ 1,383	\$ 1,621	\$ 1,426	\$ 1,429	\$ 1,443	\$ 1,434	\$ 1,438	\$ 1,433

Amortization Schedule
Amortization Schedule
0%
0%

Amortization Schedule

FIVE-YEAR FORECAST

BUILDING FUND SUMMARY

(Amounts in Thousands: \$100 = \$100,000)

	Current Fiscal Year Estimated					Current Budget		Forecast		ASSUMPTIONS
	FY 2021	FY 2022	FY 2023	FY 2024	FY 2025	FY 2026	FY 2027	FY 2028	FY 2029	
RESOURCES										
BEGINNING FUND BALANCE	\$ 2,295	\$ 2,569	\$ 3,470	4,561	4,788	4,804	3,950	2,375	1,497	
REVENUES										
Fees & Charges	1,045	1,917	1,918	1,053	1,432	1,136	1,170	1,205	1,241	3%
Intergovernmental	-	-	-	-	-	-	-	-	-	3%
Interest Income	18	10	120	118	75	75	76	76	76	1%
Miscellaneous	1	3	3	5	2	2	2	2	2	3%
TOTAL REVENUES	1,064	1,930	2,041	1,176	1,509	1,213	1,248	1,283	1,319	
TOTAL RESOURCES	\$ 3,359	\$ 4,499	\$ 5,511	\$ 5,737	\$ 6,297	\$ 6,017	\$ 5,198	\$ 3,658	\$ 2,816	
REQUIREMENTS										
EXPENDITURES										
Personnel Services	402	430	418	450	475	487	521	542	564	Averaged of 3%-7%
Materials & Services	118	309	322	289	679	627	646	665	685	3%
Capital Outlay	-	-	-	-	100	34	40	-	-	Capital Improvement Plan
Transfers to Other Funds	270	290	210	210	239	239	246	254	261	3%
Contingency	-	-	-	-	-	680	1,370	700	680	3%
TOTAL EXPENDITURES	790	1,029	950	949	1,493	2,067	2,823	2,161	2,190	
FUND BALANCE										
Policy Requirement (50%)	400	510	480	470	700	680	1,370	700	680	
Over (Under) Policy	2,169	2,960	4,081	4,318	4,104	3,950	1,005	797	(54)	
TOTAL ENDING FUND BALANCE	2,569	3,470	4,561	4,788	4,804	3,950	2,375	1,497	626	
TOTAL REQUIREMENTS	\$ 3,359	\$ 4,499	\$ 5,511	\$ 5,737	\$ 6,297	\$ 6,017	\$ 5,198	\$ 3,658	\$ 2,816	

FIVE-YEAR FORECAST

CONSTRUCTION EXCISE TAX FUND SUMMARY

(Amounts in Thousands: \$100 = \$100,000)

	Current Fiscal Year Estimated					ASSUMPTIONS				
	FY 2021	FY 2022	FY 2023	FY 2024	FY 2025	FY 2026	FY 2027	FY 2028	FY 2029	
RESOURCES										
BEGINNING FUND BALANCE	\$ 400	\$ 665	\$ 1,267	\$ 2,314	\$ 739	\$ 680	\$ 562	\$ 500	\$ 436	
REVENUES										
Incentives/Tax	122	577	925	95	234	234	241	248	256	3%
Intergovernmental	132	-	-	-	-	-	-	-	-	0%
Interest Income	5	4	49	41	10	10	10	11	11	1%
Miscellaneous	138	26	6	4	10	10	10	11	11	0%
Transfers from other funds	-	-	132	-	-	-	-	-	-	
TOTAL REVENUES	397	607	1,112	140	254	254	262	269	278	
TOTAL RESOURCES	\$ 797	\$ 1,272	\$ 2,379	\$ 2,454	\$ 993	\$ 934	\$ 823	\$ 769	\$ 714	
REQUIREMENTS										
EXPENDITURES										
Materials & Services	132	5	50	1,700	300	300	309	318	328	3%
Transfers to Other Funds	-	-	15	15	13	13	13	14	14	3%
Contingency	-	-	-	-	-	60	1	1	1	10% of M&S
TOTAL EXPENDITURES	132	5	65	1,715	313	373	323	333	343	
FUND BALANCE										
Policy Requirement (17%)	22	1	9	289	51	51	155	159	164	17% of M&S
Over (Under) Policy	643	1,266	2,306	450	629	511	345	277	207	
TOTAL ENDING FUND BALANCE	665	1,267	2,314	739	680	562	500	436	370	
TOTAL REQUIREMENTS	\$ 797	\$ 1,272	\$ 2,379	\$ 2,454	\$ 993	\$ 934	\$ 823	\$ 769	\$ 714	

FIVE-YEAR FORECAST

SYSTEM DEVELOPMENT CHARGES FUND SUMMARY

(Amounts in Thousands; \$100 = \$100,000)

	RESOURCES					ASSUMPTIONS				
	FY 2021	FY 2022	FY 2023	Current Fiscal Year Estimated FY 2024	Current Budget +1 FY 2025	Current Budget +2 FY 2026	+3 FY 2027	Forecast +4 FY 2028	+5 FY 2029	
BEGINNING FUND BALANCE	\$ 1,775	\$ 1,700	\$ 2,277	\$ 2,485	\$ 2,937	\$ 3,357	\$ 3,447	\$ 3,614	\$ 3,939	
REVENUES										
FEE & CHARGES										
Transportation	88	193	214	187	643	114	117	121	125	3%
Water	17	76	9	155	204	68	70	72	74	3%
Wastewater	30	270	(27)	490	32	16	16	17	17	3%
Stormwater	36	112	66	269	172	18	19	19	20	3%
TOTAL FEES & CHARGES	171	651	262	1,101	1,051	216	222	229	236	
Intergovernmental - Transportation					250					0%
Interest Income	11	18	71	2	114	94	95	96	97	1%
Transfers In	23									0%
TOTAL REVENUES	205	669	333	1,103	1,415	310	317	325	333	
TOTAL RESOURCES	\$ 1,980	\$ 2,369	\$ 2,610	\$ 3,588	\$ 4,352	\$ 3,667	\$ 3,764	\$ 3,939	\$ 4,272	
REQUIREMENTS										
EXPENDITURES										
MATERIALS & SERVICES										
Transportation		3	3		50					
Stormwater		3	3			35				
TOTAL MATERIALS & SERVICES		13	11		50	35				
CAPITAL OUTLAY										
Transportation	62		114	431	500					
Water	108	45								
Wastewater	110	34		220	170	150	150			
Stormwater					275	35				
TOTAL CAPITAL OUTLAY	280	79	114	651	945	185	150			Capital Improvement Plan
Contingency										10% of PS, M&S and DS
TOTAL EXPENDITURES	280	92	125	651	995	220	150			
FUND BALANCE										
Policy Requirement (25%)		3	3		13	9				
Over (Under) Policy	1,700	2,274	2,482	2,937	3,344	3,438	3,614	3,939	4,272	
TOTAL ENDING FUND BALANCE	1,700	2,277	2,485	2,937	3,357	3,447	3,614	3,939	4,272	
TOTAL REQUIREMENTS	\$ 1,980	\$ 2,369	\$ 2,610	\$ 3,588	\$ 4,352	\$ 3,667	\$ 3,764	\$ 3,939	\$ 4,272	

FIVE-YEAR FORECAST

TRANSORTATION FUND SUMMARY

(Amounts in Thousands: \$100 = \$100,000)

	FY 2021	FY 2022	FY 2023	Current Fiscal Year Estimated FY 2024	Current Budget		+3 FY 2027	Forecast +4 FY 2028	+5 FY 2029	ASSUMPTIONS
					+1 FY 2025	+2 FY 2026				
RESOURCES										
BEGINNING FUND BALANCE	\$ 18,950	\$ 15,220	\$ 10,318	\$ 26,973	\$ 25,640	\$ 15,248	\$ 7,082	\$ 608	\$ (2,678)	
REVENUES										
STREET SURFACE MAINTENANCE PROGRAM (SSMP)										
Street Maintenance Fee	956	981	1,035	1,080	1,235	1,305	1,344	1,384	1,426	3%
Intergovernmental - Local Gas Tax	116	122	128	117	130	130	134	138	142	3%
Franchise Fees (1.5% Privilege Tax)	338	353	369	400	390	408	420	433	446	3%
Interest Income	65	70	122	189	50	50	51	51	52	1%
Proceeds from Issuance of Debt	-	-	6,207	-	-	-	-	-	-	0%
TOTAL SSMP	1,475	1,526	7,861	1,786	1,805	1,893	1,949	2,006	2,065	
SAFE STREETS FOR EVERYONE PROGRAM (SAFE)										
SAFE Fee	1,136	1,175	1,253	1,296	1,415	1,515	1,560	1,607	1,655	3%
Intergovernmental - Other	230	174	12	-	2,000	3,500	3,500	3,500	3,500	0%
Interest Income	49	57	102	200	100	100	100	100	100	0%
Proceeds from Issuance of Debt	-	-	8,722	-	-	-	-	-	-	0%
TOTAL SAFE	1,415	1,406	10,089	1,496	3,515	5,115	5,160	5,207	5,255	
STATE GAS TAX PROGRAM (STREETS)										
Intergovernmental										
State Gas Tax	1,560	1,673	1,673	1,675	1,673	1,673	1,723	1,775	1,828	3%
County Vehicle Registration Fee	411	394	420	420	425	425	438	451	464	3%
Other	159	58	-	59	-	-	-	-	-	0%
Franchise Fees (from Utility Funds)	892	932	1,094	1,109	1,103	1,120	1,154	1,188	1,224	3%
Interest Income	(28)	49	151	185	100	75	75	75	75	0%
Reimbursement Fee - SDC	4	10	11	5	32	6	6	6	6	0%
FILOC Revenue	14	32	-	-	10	10	10	10	10	0%
Miscellaneous	8	46	13	3	2	2	2	2	2	0%
Proceeds from Issuance of Debt	-	-	3,954	-	-	-	-	-	-	0%
TOTAL STREETS	3,069	3,194	7,316	3,456	3,345	3,311	3,408	3,507	3,609	
TOTAL REVENUES	5,959	6,126	25,266	6,738	8,665	10,315	10,517	10,720	10,930	
TOTAL RESOURCES	\$ 24,909	\$ 21,346	\$ 35,584	\$ 33,711	\$ 34,305	\$ 25,567	\$ 17,599	\$ 11,328	\$ 8,252	

Continued on next page.

TRANSPORTATION FUND SUMMARY, continued

(Amounts in Thousands; \$100 = \$100,000)

REQUIREMENTS	FY 2021	FY 2022	FY 2023	Current Fiscal Year Estimated FY 2024	Current Budget		+3 FY 2027	Forecast +4 FY 2028	+5 FY 2029	ASSUMPTIONS
					+1 FY 2025	+2 FY 2026				
EXPENDITURES										
Personnel Services	563	649	665	708	714	733	784	816	848	Averaged of 3%-7%
Materials & Services	385	614	607	457	695	540	556	573	590	3%
Capital Outlay	4,715	7,033	3,155	2,693	13,416	12,846	10,773	8,759	6,996	Capital Improvement Plan
Debt Service	1,996	642	1,848	1,968	1,987	1,987	2,000	1,000	1,000	Scheduled
Transfers to Other Funds	2,030	2,090	2,236	2,245	2,245	2,245	2,312	2,382	2,453	3%
Contingency	-	-	-	-	-	134	565	477	489	10% of PS, M&S and DS
TOTAL EXPENDITURES	9,689	11,028	8,611	8,071	19,057	18,485	16,991	14,006	12,377	
FUND BALANCE										
Policy Requirement (17%)	510	570	600	580	620	600	621	641	662	
Over (Under) Policy	14,710	9,748	26,373	25,040	14,628	6,482	(13)	(3,319)	(4,786)	
TOTAL ENDING FUND BALANCE	15,220	10,318	26,973	25,640	15,248	7,082	608	(2,678)	(4,124)	
TOTAL REQUIREMENTS	\$ 24,909	\$ 21,346	\$ 35,584	\$ 33,711	\$ 34,305	\$ 25,567	\$ 17,599	\$ 11,328	\$ 8,252	

FIVE-YEAR FORECAST

WATER FUND SUMMARY

(Amounts in Thousands; \$100 = \$100,000)

(Amounts in Thousands; \$100 = \$100,000)

	FY 2021	FY 2022	FY 2023	Current Fiscal Year Estimated		Current Budget		FY 2027	FY 2028	FY 2029	ASSUMPTIONS
				FY 2024	FY 2025	FY 2026	FY 2027				
RESOURCES											
BEGINNING FUND BALANCE	\$ 4,630	\$ 4,546	\$ 5,395	6,717	6,136	3,782	2,733	340	(3,067)		
REVENUES											
Fees & Charges	4,471	4,366	4,691	5,045	5,201	5,355	5,516	5,681	5,852	3%	
Reimbursement Fees	20	91	11	43	204	68	70	72	74	3%	
Intergovernmental - ARPA	-	-	-	-	3,695	-	-	-	-	3%	
Interest Income	2	16	279	300	120	75	76	77	77	1%	
Miscellaneous	90	62	15	36	19	19	20	20	21	3%	
Transfers in (CARES Act)	-	-	-	-	-	-	-	-	-	0%	
TOTAL REVENUES	4,583	4,535	4,996	5,424	9,239	5,517	5,681	5,850	6,024		
TOTAL RESOURCES	\$ 9,213	\$ 9,081	\$ 10,391	\$ 12,141	\$ 15,375	\$ 9,299	\$ 8,414	\$ 6,190	\$ 2,957		
REQUIREMENTS											
EXPENDITURES											
Personnel Services	873	907	946	917	1,128	1,158	1,239	1,289	1,340	Averaged of 3%-7%	
Materials & Services	926	1,033	998	1,133	1,197	1,225	1,262	1,300	1,339	3%	
Capital Outlay	1,588	416	156	2,375	7,714	2,573	3,222	4,244	7,037	Capital Improvement Plan	
Transfers to Other Funds	1,280	1,340	1,574	1,580	1,554	1,554	1,601	1,649	1,698	3%	
Contingency	-	-	-	-	-	56	750	776	804	30% of PS & M&S	
TOTAL EXPENDITURES	4,667	3,696	3,674	6,005	11,593	6,566	8,074	9,257	12,217		
FUND BALANCE											
Policy Requirement (50%)	1,540	1,640	1,760	1,820	1,940	1,970	2,051	2,118	2,188		
Over (Under) Policy	3,006	3,745	4,957	4,316	1,842	763	(1,710)	(5,185)	(11,449)		
TOTAL ENDING FUND BALANCE	4,546	5,385	6,717	6,136	3,782	2,733	340	(3,067)	(9,261)		
TOTAL REQUIREMENTS	\$ 9,213	\$ 9,081	\$ 10,391	\$ 12,141	\$ 15,375	\$ 9,299	\$ 8,414	\$ 6,190	\$ 2,957		

FIVE-YEAR FORECAST

WASTEWATER FUND SUMMARY

(Amounts in Thousands; \$100 = \$100,000)

	Current Fiscal Year Estimated FY 2024					Current Budget +2		Forecast +4		ASSUMPTIONS
	FY 2021	FY 2022	FY 2023	FY 2024	+1 FY 2025	+2 FY 2026	+3 FY 2027	+4 FY 2028	+5 FY 2029	
RESOURCES										
BEGINNING FUND BALANCE	\$ 5,525	\$ 5,454	\$ 5,664	5,733	4,654	2,602	2,741	659	(1,318)	
REVENUES										
Fees & Charges	8,070	8,352	8,751	9,089	9,279	9,211	9,487	9,772	10,065	3%
Proceeds from Reimbursement District	43	165	190	25	43	43	44	46	47	3%
Intergovernmental	-	5	-	-	1,762	717	-	-	-	0%
Intergovernmental - ARPA	-	-	132	-	-	-	-	-	-	0%
Intergovernmental - Good Neighbor	-	-	-	-	-	-	-	-	-	0%
Interest Income	15	23	239	140	100	75	76	77	77	1%
Miscellaneous	4	29	4	7	14	14	14	15	15	3%
Transfers In (CARES Act)	49	-	-	-	-	-	-	-	-	0%
TOTAL REVENUES	8,181	8,574	9,316	9,261	11,198	10,060	9,622	9,909	10,205	
TOTAL RESOURCES	\$ 13,706	\$ 14,028	\$ 14,980	\$ 14,994	\$ 15,852	\$ 12,662	\$ 12,362	\$ 10,568	\$ 8,887	
REQUIREMENTS										
EXPENDITURES										
Personnel Services	448	506	536	557	583	599	641	667	693	Averaged of 3%-7%
Materials & Services	5,537	5,584	5,609	5,611	5,945	5,999	6,179	6,364	6,555	3%
Capital Outlay	886	843	1,546	2,521	5,080	1,645	2,266	2,161	881	Capital Improvement Plan
Debt Service	101	101	101	191	191	193	100	100	100	Amortization Schedule
Transfers to Other Funds	1,280	1,330	1,455	1,460	1,451	1,451	1,495	1,539	1,586	3%
Contingency	-	-	-	-	-	34	1,023	1,055	1,087	Contingency of PS & M&S
TOTAL EXPENDITURES	8,252	8,364	9,247	10,340	13,250	9,921	11,703	11,886	10,902	
FUND BALANCE										
Policy Requirement (25%)	1,840	1,880	1,930	1,950	2,040	2,060	2,104	2,168	2,234	
Over (Under) Policy	3,614	3,784	3,803	2,704	562	681	(1,445)	(3,486)	(4,249)	
TOTAL ENDING FUND BALANCE	5,454	5,664	5,733	4,654	2,602	2,741	659	(1,318)	(2,016)	
TOTAL REQUIREMENTS	\$ 13,706	\$ 14,028	\$ 14,980	\$ 14,994	\$ 15,852	\$ 12,662	\$ 12,362	\$ 10,568	\$ 8,887	

FIVE-YEAR FORECAST

STORMWATER FUND SUMMARY

(Amounts in Thousands; \$100 = \$100,000)

(Amounts in Thousands; \$100 = \$100,000)

	FY 2021	FY 2022	FY 2023	Current Fiscal Year Estimated FY 2024	Current Budget		FY 2027	Forecast +4 FY 2028	+5 FY 2029	ASSUMPTIONS
					+1 FY 2025	+2 FY 2026				
RESOURCES										
BEGINNING FUND BALANCE	\$ 5,132	\$ 6,090	\$ 7,056	8,940	7,707	1,633	1,957	(27)	(403)	
REVENUES										
Fees & Charges	5,118	5,200	5,151	5,185	5,222	5,251	5,409	5,571	5,738	3%
Intergovernmental	308	61	-	585	-	-	-	-	-	3%
Interest Income	25	22	262	275	60	60	61	61	62	1%
Miscellaneous	33	45	83	17	17	17	18	18	19	3%
Transfers in (CARES Act)	56	-	-	-	-	-	-	-	-	0%
TOTAL REVENUES	5,540	5,328	5,496	6,062	5,299	5,328	5,487	5,650	5,818	
TOTAL RESOURCES	\$ 10,672	\$ 11,418	\$ 12,552	\$ 15,002	\$ 13,006	\$ 6,961	\$ 7,444	\$ 5,623	\$ 5,415	
REQUIREMENTS										
EXPENDITURES										
Personnel Services	701	744	741	804	877	902	965	1,004	1,044	Averaged of 3%-7%
Materials & Services	660	868	722	740	793	801	825	850	875	3%
Capital Outlay	1,861	1,330	724	4,346	8,303	1,856	3,970	2,410	3,412	Capital Improvement Plan
Debt Service	-	-	-	-	-	-	-	-	-	Amortization Schedule
Transfers to Other Funds	1,360	1,420	1,425	1,405	1,400	1,400	1,442	1,485	1,530	3%
Contingency	-	-	-	-	-	45	269	278	288	Contingency of PS & M&S
TOTAL EXPENDITURES	4,582	4,362	3,612	7,295	11,373	5,004	7,471	6,027	7,149	
FUND BALANCE										
Policy Requirement (25%)	680	760	720	740	770	780	808	835	862	
Over (Under) Policy	5,410	6,296	8,220	6,967	863	1,177	(835)	(1,238)	(2,596)	
TOTAL ENDING FUND BALANCE	6,090	7,056	8,940	7,707	1,633	1,957	(27)	(403)	(1,734)	
TOTAL REQUIREMENTS	\$ 10,672	\$ 11,418	\$ 12,552	\$ 15,002	\$ 13,006	\$ 6,961	\$ 7,444	\$ 5,623	\$ 5,415	

Index of Budget Terms

Actual – Actual, as used in the Fund summaries, revenue summaries and department and division summaries within the budget document, represents the actual financial results. This category is presented on a budgetary basis, and thus excludes full-accrual audit items such as depreciation and amortization.

Ad Valorem Tax – A tax based on the assessed value of a property.

Adopted Budget – Adopted, as used in the Fund summaries, revenue summaries and department and division summaries within the budget document, represents the final budget approved by the city council. The adopted budget becomes effective July 1. After adoption, Council may make changes throughout the year.

America Rescue Plan Act (ARPA) – In 2021, the act was signed into law to provide \$350 billion in additional funding for state and local governments. This act is a response to the COVID-19 pandemic offering a stimulus package for the economy.

America Rescue Plan Act (ARPA) Parks – The state allocated in 2021 a portion of federal dollars received in the stimulus package to communities to create or upgrade outdoor spaces in response to the COVID-19 pandemic.

Annual Comprehensive Financial Report (ACFR) – The annual audit document publishing the city’s financial results including notes, statistics, and the auditor’s opinion and comments.

Approved Budget – Approved, as used in the Fund summaries, revenue summaries and department and division summaries within the budget document, represents the proposed budget modified for any changes made by the budget committee.

Appropriations – Legal authorization granted by the city council to spend public funds. Appropriations within each category may not be exceeded.

Assessed Valuation (AV) – The assessed value (AV) set on taxable property as a basis for levying property taxes. A tax initiative passed in 1997 that reduced AV below real market value and set a 3% maximum annual growth rate in the AV, exclusive of certain improvements.

Assets – Resources having a monetary value and that are owned or held by an entity.

Audit – An annual financial report prepared by management and audited by an independent auditing firm. An audit document contains a summary statement of the scope of the audit, explanatory comments concerning any exceptions to generally accepted auditing standards, explanatory comments concerning verification procedures, financial statements and schedules, statistical information, supplemental comments, and any finding or recommendations.

Basis of Accounting – As per Generally Accepted Accounting Principles (GAAP), the modified accrual basis of accounting is used by all governmental fund types and agency funds (general fund, special revenue funds, capital projects funds, and trust funds). Under the modified accrual basis of accounting, revenues are recorded as collected unless susceptible to accrual, such as amounts measurable and available to finance the city's operations. "Available" means collectible within the current period or soon thereafter to be used to pay liabilities of the current period. Significant revenues, which are considered susceptible to accrual, include sales tax, utility franchise taxes, interest, and certain state and federal grant entitlements. Licenses, permits, fines and forfeitures, charges for services and miscellaneous revenue are recorded as revenues when received in cash because they are generally not measurable until actually received. Expenditures, other than debt service on long-term debts, are recorded when the liability is incurred. The accrual basis of accounting is utilized by the proprietary fund types (enterprise funds). Under this basis of accounting, revenues are recognized when earned and expenses are recorded when liabilities are incurred. The city's fiscal year end is June 30.

Basis of Budgeting – Budgets for the general, special revenue and capital projects funds are prepared and adopted on a basis consistent with GAAP. Budgeting in the enterprise funds is prepared and adopted on a basis consistent with GAAP, except that bond principal payments and capital improvements are treated as expenses.

Balanced Budget – A budget for which expenditures and ending fund balance are equal to net available resources (beginning fund balance plus revenues).

Base Budget – Cost of continuing the existing levels of service in the current budget year. This is also referred to as a Status Quo budget.

Beginning Fund Balance – The beginning fund balance is the residual fund balances representing unused funds brought forward from the previous financial year (ending fund balance).

Bond or Bond Issued – Bonds are debt instruments that require repayment of a specified principal amount on a certain date (maturity date), together with interest at a stated rate or calculated variable rate of interest.

Bond Fund – Established to account for bond proceeds to be used only for approved bond projects.

Budget – A budget is a financial operational plan including an estimate of proposed expenditures and the means of financing them. Used without any modifier, the term usually indicates a financial plan for a certain period, typically one or two years. In practice, the term budget is used in two ways – sometimes it designates the financial plan presented for adoption and other times it designates the plan finally approved. It is usually necessary to specify whether the budget under consideration is preliminary and proposed, or whether the appropriating body has approved it.

Budget Calendar – This is the schedule of key dates which a government follows to prepare and adopt the budget.

Budget Committee – A group comprised of the elected officials plus an equal number of citizens for the purpose of reviewing the proposed budget and recommending changes leading to an approved budget.

Budget Document – A written report showing a government's comprehensive financial plan for a specified period, typically one or two years that includes both capital and operations.

Budget Message – Written explanation of the budget as proposed by the city manager, including the city's financial priorities, policies, and target goals for the coming budget period.

Budgetary Basis – Budgets are adopted on a basis consistent with GAAP, with the exception that neither depreciation nor amortization is budgeted for proprietary funds and bond principal in the enterprise funds is subject to appropriation.

Capital Budget – The portion of the city budget slated for projects, major repairs, and improvements or additions to the city's capital assets (streets, sidewalks, roads, sewers, storm water, and buildings).

Capital Expenditures – The city defines a capital expenditure as using the following three criteria: (1) relatively high monetary value (equal or greater than \$10,000 per item), (2) long asset life (equal to or greater than one year of the useful life), and (3) results in the creation of a capital asset or the revitalization of a capital asset.

Capital Improvement – A term defined in ORS 310.140(f) to include land, structures, facilities, machinery, equipment, or furnishings having a useful life of longer than one year.

Capital Improvement Plan (CIP) – A schedule of capital projects including estimated cost and timing. The CIP includes each major infrastructure system in the city, e.g., water, streets, sidewalks, storm water, wastewater, information technology, city facilities and vehicles.

Capital Improvement Project – Any project having improvements of significant value and having a useful life of five years or more. Capital projects include the purchase of land, design, engineering and construction of buildings, and infrastructure items such as streets, bridges, drainage, street lighting, water and sewer systems and master planning.

Capital Outlay – Includes the purchase of land, the purchase or construction of buildings, structures, and facilities of all types, plus machinery and equipment. It includes expenditures that result in the acquisition or addition of a capital asset or increase the capacity, efficiency, span of life, or economy of operating as an existing capital asset. For an item to qualify as a capital outlay expenditure it must meet all the following requirements: (1) have an estimated useful life of more than one year; (2) have a cost of \$10,000 or more per item; and (3) be a betterment or improvement. Replacement of a capital item is classified as capital outlay under the same code as the original purchase. Non-capital part replacement or repairs are classified under materials and services.

Cash Management – Management of cash necessary to pay for government services while investing temporary cash excesses to earn investment income. This includes forecasting inflows and outflows of cash, mobilizing cash to improve its availability for investment, establishing and maintaining banking relationships, and investing funds in accordance with the city's investment policy objectives.

Category Level – For budget control purposes, categories include personnel services, materials and services, capital outlay, debt service, transfers, contingency, reserves and unappropriated ending fund balance.

Charges for Service – Includes a wide variety of fees charged for services provided to the public and other agencies.

Citizens Utility Advisory Board (CUAB) - The Citizens Utility Advisory Board was established to advise the City Council on the methods and means for city utility rates and capital improvements that are scheduled and carried out. The mayor, with the consent of Council, appoints five members for two-year terms, with a maximum of six consecutive years. Each member is appointed at-large and is a Milwaukie taxpayer throughout their term.

Comprehensive Plan – This is an official statement of the goals, objectives, and physical plan for the development of the city which contains a narrative of goals, objectives and policies that describe the desired form, nature, and rate of city development.

Consumer Price Index (CPI) – A statistical description of price levels provided by the U.S. Department of Labor. The index is used as a measure of the increase in the cost of living (i.e., economic inflation).

Contingency – A budgetary reserve set aside for emergencies or unforeseen expenditures not otherwise budgeted. Contingency may be appropriated for a specific purpose by the city council upon adoption of a resolution. The city can separate contingencies into those that are designated for specific purposes and undesignated (also see Designated Contingency and Unappropriated Ending Fund Balance).

Cost Center - An organizational budget or operating unit within each city division or department.

Centum Cubic Feet (CCF) – Unit of measure for industrial consumption of water that represents 100 cubic feet.

Debt Coverage Ratio (DCR) – Represents the ratio of “net revenues” available to pay scheduled debt service. A ratio of 1.0 reflects “net revenues” equal to scheduled debt service. A ratio greater than 1.0 reflects “net revenues” in excess of scheduled debt service and a ratio less than 1.0 indicates “net revenue” is less than scheduled debt service.

Debt Service – Principal and interest on outstanding bonds due and payable during the fiscal year.

Debt Service Fund – A fund to account for the accumulation of resources and for the payment of general obligation debts that have been approved by the voters. It would exclude Enterprise Fund debt and contractual obligations accounted for in other individual funds.

Department – The combination of divisions of the city, headed by a general manager with a specific and unique set of goals and objectives (i.e., Police, Finance, Human Resources, etc.).

Division – A functional unit within a department consisting of one or more cost centers engaged in activities supporting the unit’s mission and objectives.

Divisional level – For budget control purposes, a divisional level would include water, streets, storm water, and wastewater divisions within the public works department.

Depreciation – Expiration in the service life of capital assets attributable to wear and tear, deterioration, action of physical elements, inadequacy, or obsolescence.

Designated Contingency – Amounts set aside for anticipated non-recurring cash flow needs, including items such as moving and remodeling, major building repairs, emergency management and capital project or equipment purchases.

Employee Benefits – Contributions made by a government to meet commitments or obligations for employee-related expenses. Included is the government's share of costs for social security and retirement benefits, medical and life insurance plans.

Encumbrance – Amount of money committed and set aside, but not yet expended, for the purchase of goods or services.

Ending Fund Balance – The residual non-restricted funds that are spendable or available for appropriation after the end of the fiscal year, or during the fiscal year, if a state of emergency is declared by the city manager.

Enterprise Fund – Established to account for operations, including debt service that are financed and operated similarly to private businesses – where the intent is that the service is self-sufficient, with all costs supported by user charges.

Estimated – A projection of revenue or expenditure, as appropriate, to be recognized during the current fiscal period.

Expenditures – Represents decreases in net financial resources, including outflows for current operating costs, which require the current or future use of net current assets, debt service, and capital outlay.

Fees – Charges for specific services in connection with providing a service, permitting an activity, or imposing fines.

Fiscal Management – A government's directive with respect to revenues, spending, reserves and debt management as these relate to governmental services, programs, and capital investment. Financial policy provides an agreed upon set of principles for the planning and programming of governmental budgets and its funding.

Fiscal Year – A twelve-month period designated as the operating year for accounting and budgeting purposes in an organization. The city's fiscal year is July 1 through June 30.

Five-year Financial Forecast – An estimate of revenues and expenses required by the city to operate for the next five-year period.

Franchise Fee – Charged to all utilities operating within the city and is a reimbursement to the General Fund or Transportation Fund for the utility’s use of city streets and rights-of-way.

Full-Time Equivalent (FTE) – A calculation used to convert part-time hours to equivalent full-time positions. Full-time employee salaries are based on 2,080 hours per year. The full-time equivalent of a part-time employee is calculated by dividing the number of hours budgeted by 2,080.

Fund – A fiscal and accounting entity with a self-balancing set of accounts. Records cash and other financial resources together with all related liabilities and residual equities or balances and changes therein. These are segregated for the purpose of carrying on specific activities or attaining certain objectives in accordance with special regulations, restrictions, or limitations.

Fund Accounting – An accounting system emphasizing accountability rather than profitability, used by governments and some not-for-profit organizations. In this system, a fund is a self-balancing set of accounts, segregated for specific purposes in accordance with laws and regulations or special restrictions and limitations.

Fund Balance – The net ending balance of a fund’s financial resources that are spendable or available for appropriation.

General Fund – The primary operating fund of the city. It exists to account for the resources devoted to finance the services traditionally associated with local government.

General Long-term Debt – Represents any unmatured debt not considered to be a fund liability. General Obligation Bonds (GO Bonds) are secured by the full faith and credit of the issuer. GO Bonds issued by local units of government are secured by a pledge of the issuer’s property taxing power, usually to pay for general capital improvements such as parks and city facilities.

Government Finance Officers Association (GFOA) – The national finance officers’ organization whose purpose is to enhance and promote the professional management of governments for the public benefit by identifying and developing financial policies and best practices and promoting their use through education, training, facilitation of member networking, and leadership.

Grant – A contribution by one government unit to another. The contribution is usually made to aid in the support of a specified function (i.e., library, transit or capital projects). Infrastructure public domain capital assets typically include roads, bridges, streets, sidewalks, and similar assets that are immovable.

Indirect Charges – Administrative and overhead costs that are incurred in one area but charged to another. These charges are budgeted as interfund transfers.

Indirect Cost Allocation – Funding transferred from one fund to another for specific administrative functions, which benefit those funds.

Interfund Transfers – Appropriation category used in the city's budget resolution which includes amounts distributed from one fund to pay for services provided by another fund. Transfers from the other Fund is appropriated as an expenditure.

Intergovernmental Revenues – Levied by one government but shared on a predetermined basis with another government or class of governments.

Levy – Gross amount of property taxes imposed on the assessed value of taxable property. The net amount received by a government will be less than the gross levy because of delinquent, uncollectible payments, or early payment discounts. Budgets are developed based on the projected amount of property taxes receivable.

Line-Item Budget – References the individual account lines of budget, where proposed appropriations are based on individual objects of expense within a department or program.

Local Budget Law – Oregon Revised Statutes Chapter 294 dictates local budgeting practices governed by local budget law which regulates budget roles, authorities, and process.

Local Improvement District – Consists of a group of property owners desiring improvements to their property. Bonds can be issued to finance these improvements, which are repaid by assessments on their property. Local improvement district debt is paid for by a compulsory levy (special assessment) made against affected properties to spread out the cost of a specific capital improvement or service deemed to benefit primarily those properties.

Local Option Levy – Under Measure 50, local governments and special districts were given the ability to ask voters for temporary authority to increase taxes through approval of a local option levy. The maximum length of time for a local option levy is 10 years for capital purposes or 5 years for operations. A local option levy must be approved by most of the voters.

Materials and Services – Expendable items purchased for delivery of city services. This classification includes supplies, dues, printing, repairs, small tool acquisitions, and contract services that are not of a capital nature.

Measure 5 – A constitutional limit on property taxes passed by voters in the State of Oregon in November 1990. The law sets maximum tax rates on individual properties of no more than \$5 per real market value for education taxing districts and \$10 for general government taxing districts.

Measure 47/50 – A 1997 voter approved initiative which rolled back assessed values to 90 percent of their levels in fiscal year 1995-96 and limits future annual increases to three percent, except for major improvements. Property tax rates are now considered permanent and not subject to change.

Mission – The primary purpose of the city and is intended to guide all organizational decisions, policies, and activities (internal and external) daily.

Non-Operating Budget – Part of the budget composed of the following categories: debt service, capital outlay, contingencies, and unappropriated ending fund balances.

Objective – A target to be accomplished in specific, well-defined, and measurable terms, and that is achievable within a specific time frame.

Operating Budget – The plan for current expenditures and the proposed means of financing them. The annual operating budget is the primary means by which most of the financing, acquisition, spending and service delivery activities of a government are controlled. On the expenditure side, it is the part of the budget composed of personnel services, materials, and services, and interfund transfers.

Operating Revenue – Funds that the government receives as income to pay for ongoing operations. It includes such items as taxes, fees for specific services, interest earnings and grant revenues. Operating revenues are used to pay for day-to-day services.

Ordinance – A formal legislative enactment by the governing body of a municipality. If it is not in conflict with any higher form of law, such as a state statute or a constitutional provision, it represents the full force and effect of the law within the boundaries of the municipality to which it applies.

Oregon Revised Statutes (ORS) – Oregon’s compilation of state laws including rules of civil procedure.

Outstanding Debt – The balance due at any given time resulting from the borrowing of money or from the purchase of goods and services.

Performance Measure – Data collected to determine how the effectiveness or efficiency of a department, program, or activity is doing in achieving its objectives.

Permanent Tax Rate – Under Measure 47/50, each taxing district such as a school district, city government, county, and special district was assigned a permanent tax rate maximum in fiscal year 1997-98. This permanent tax rate applies to property taxes for core operations. The permanent tax rate for the City of Milwaukie was set at \$6.5379 per \$1,000 of assessed value, reduced each year by Clackamas Fire District’s tax rate.

Personnel Services – Includes the compensation paid to employees plus the city’s contribution for employee benefits such as retirement, social security, health and dental insurance, and workers’ compensation costs.

Program Level – For budget control purposes, programs may include library services, community services, administration, finance, human resources, etc.

Property Tax – Based on the assessed value of property (which in Oregon is much lower than the real market value) multiplied by the permanent tax rate and used as the source of monies to pay for general obligation debt and core city services.

Project Manager – The individual responsible for budgeting, managing, and coordinating projects through completion.

Proposed Budget – Combines the operating, non-operating, and reserve estimates prepared by the city manager, then presented to the community and the budget committee for review, approval, and recommendation to city council.

Real Market Value (RMV) – The estimated value of property as if it were sold. Within the City, the average real market value exceeds the assessed value by just about one third. This disparity is the result of voter approved tax Measure 47/ 50 passed in 1997.

Resolution – A special or temporary order of a legislative body requiring city council action (also see Ordinance).

Resources – Represents the total of all revenues, transfers, and beginning fund balances.

Revenues – Funds received by the city from taxes, fees, or other sources such as grants and interest income.

Revenue Bonds – Bonds payable from a pledged source of revenue such as water revenues, which does not also pledge the taxing authority of the city. Pledged revenues may be derived from operation of the financed projects, grants, utility revenues, or other specified revenue streams.

Special Assessment – A compulsory levy made against certain properties to spread out the cost of a capital improvement or service deemed to be beneficial to said properties.

Special Assessment Bond – A bond issue payable from the payments on special assessments imposed against properties that have specifically benefited by the construction of public improvements such as sidewalks, streets, or sewer systems or provision of services.

Special Revenue Fund – A fund to account for the proceeds of specific revenue sources that are restricted or committed to expenditures for specified purposes.

State Revenue Sharing – A share of certain revenues from the State of Oregon that are apportioned among and distributed to the cities for general purposes. These funds require a public hearing before the budget committee to discuss possible uses.

State Shared Revenues – Revenue received from the State of Oregon for cigarette, liquor, and highway taxes under ORS 221. These funds are available to cities located in counties with at least one hundred thousand inhabitants that provide at least four types of municipal services.

Supplemental Budget – Additional appropriations established to meet needs not anticipated at the time the budget was originally adopted. A supplemental budget cannot increase the tax levy.

Systems Development Charges (SDC) – Charges paid by developers and builders to fund expansion of infrastructure systems necessary due to increased usage. Such charges are collected for water, sewer, surface water, and streets and are paid as part of the permit process.

Taxes – Compulsory charges levied by taxing districts for the purpose of financing services performed for the common benefit. This term does not include specific charges made against a person or property for current or permanent benefits such as special assessments. The does not include charges for services rendered only to those paying such charges, such as water service.

Tax Levy – The total amount of property taxes needed to pay for basic government operations as well as sufficient amounts to pay for principal and interest on voter-approved bond issues.

Tax Rate – The amount of tax levied for each \$1,000 of assessed valuation, which in Oregon, represents about two-thirds of a property’s real market value.

Tax Revenue – Represents the funds received from the calculation of the tax rate multiplied by all the property’s assessed values.

Transfers – The authorized exchange of cash or other resources between funds that are appropriated along with other expenditures in the adopted budget.

Trust Funds – Established to administer resources received and held by the city as the trustee or agent for others. Use of these funds facilitate the discharge of responsibility placed upon the city by virtue of law or other similar authority.

Unappropriated Ending Fund Balance – Represents the portion of the ending fund balance that is not appropriated to be spent in the current year. It must be segregated for future use and is not available for current appropriation or expenditure, except in the event the city manager declares an emergency.

User Fees – Charges for services to the specific entity that directly benefits, often referred to as charges for service.



BUDGET TERM ACRONYMS

- ARPA – American Rescue Plan Act
- ARPA PARKS – American Rescue Plan Act Parks
- ACFR – Annual Comprehensive Financial Report
- AV – Assessed Valuation
- CIP – Capital Improvement Plan
- CUAB – Citizens Utility Advisory Board
- CPI – Consumer Price Index
- CCF – Centum Cubic Feet
- DCR – Debt Coverage Ratio
- FTE – Full-time Equivalent
- GAAP – General Accepted Accounting Principles
- GFOA – Government Finance Officers Association
- MRC – Milwaukie Redevelopment Commission
- ORS – Oregon Revised Statutes
- RMV – Real Market Value
- SDC – System Development Charges
- URA – Urban Renewal Authority

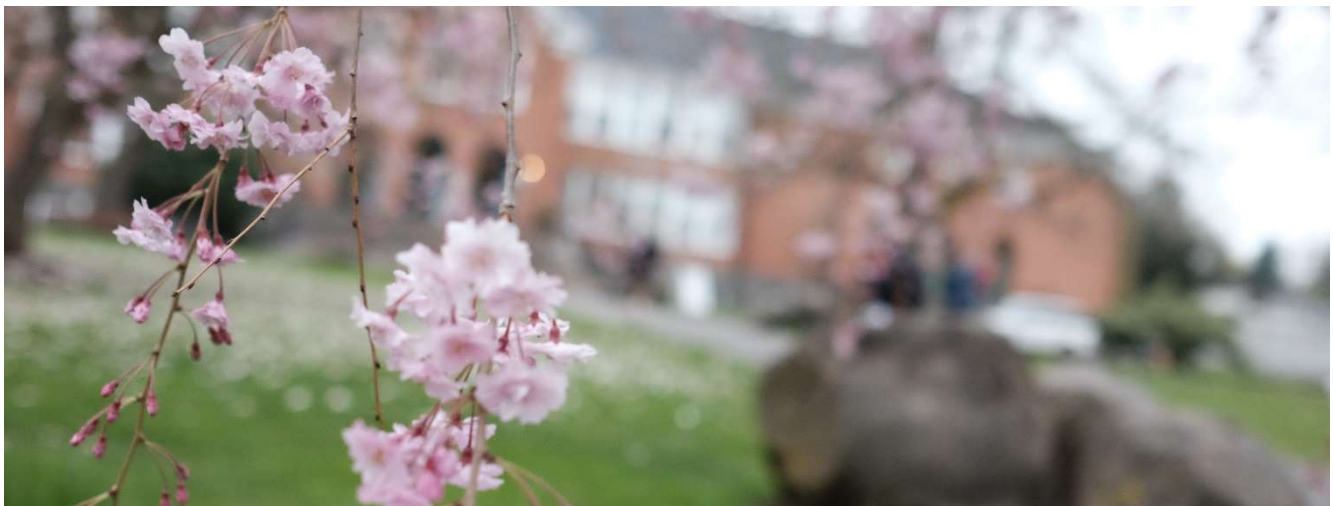



RS314



MRC

**MILWAUKIE
REDEVELOPMENT
COMMISSION**

City of Milwaukie, Oregon

**Urban Renewal Authority
Approved Budget**

2025-2026 Biennium





To: Mayor Lisa Batey, Chair
Members of the Milwaukie Redevelopment Commission
Members of the Budget Committee
Community Members of Milwaukie

I am pleased to present you with the proposed biennial budget for fiscal years 2025-2026 for the Milwaukie Redevelopment Commission (MRC). This budget cycle includes the first two years of the recently adopted five-year action plan for the Urban Renewal Area (URA).

OVERVIEW

Urban renewal activities are funded through a mechanism called Tax Increment Financing (TIF), authorized under Oregon Revised Statute 457. When the Milwaukie Urban Renewal Plan was adopted in 2016, the existing tax base for the urban renewal area was frozen – this is referred to as the frozen base. Property value increases and new development within the URA that increases revenue above the frozen base gets allocated to the MRC and can only be spent within the boundaries of the URA. TIF is important as it provides funding for redevelopment projects that enhance areas of livability and ultimately increase the tax base within the district. TIF can be used to provide much needed infrastructure, amenities and investments in new housing and commercial development, as well as improvements to existing buildings within the URA.

Milwaukie’s URA focuses primarily in the downtown and central commercial areas. The frozen base for Milwaukie’s URA is \$135,994,953. It is forecasted to reach maximum indebtedness of \$92,500,000 in 2049. Maximum indebtedness is an estimate of future property tax growth over the period based on detailed assumptions, estimates and projects from the original plan.

LOOKING BACK

By late 2020, sufficient tax increment had accrued to justify development of a five-year investment strategy for the district. Furthermore, multiple city-wide plans like the Community Vision and Action Plan (2017) and Comprehensive Plan (2020) supplied further direction on where investments should be focused. Therefore, the MRC authorized the development of a more focused, near-term investment strategy to ensure that investments align with community needs. In June of 2022, the five-year action plan was formally adopted and covers fiscal years 2023 through 2027.

LOOKING FORWARD

A 2021 financial analysis found that the district is projected to have robust growth, but not as strong as the 2016 forecast. Annual TIF increases are expected to grow rapidly which provided impetus for the MRC to pursue debt and invest up to \$10 million in projects between 2023-2028. In 2023, the city borrowed \$5.05 million via a general obligation bond to begin taking the necessary steps toward addressing many of the projects and improvements called out in five-year

action plan. Over the next biennium, staff will continue to prioritize the implementation of the five-year action plan, especially for projects funded through the general obligation bond. The second priority tier will be forming and administering economic development programs (i.e. storefront improvement and tenant improvement programs) using accrued and available increment funds that are not associated with the bond. This means that over the next two years, we will see the vision behind the URA begin to come to fruition.

CONCLUSION

The MRC is managed by city staff and conforms to the same financial policies as the city. The city is committed to responsible fiscal management through financial integrity, prudent stewardship of public assets, planning, accountability and transparency. These fiscal policies enable the city to achieve and maintain a long-term stable and positive financial condition and are the basic framework for overall financial management, day-to-day and long-range fiscal planning, and decision-making. The financial policies can be found within the city's biennial budget.

Respectfully presented this 27th day of April 2024,

A handwritten signature in black ink, appearing to read 'J. Briglio', written in a cursive style.

Joseph Briglio
Executive Director

MILWAUKIE REDEVELOPMENT COMMISSION FUND

URBAN RENEWAL AUTHORITY

DEPARTMENT DESCRIPTION AND CORE SERVICES

The Milwaukie Redevelopment Commission (MRC) is the urban renewal agency for the City of Milwaukie. The MRC was established in 1987 through adoption of Ordinance 1623. In 2015, the Milwaukie City Council directed staff to prepare an urban renewal plan – that plan was adopted in August 2016 and established the boundary of the zone, a maximum indebtedness of \$92,500,000, and an estimated 29-year implementation timeframe.

ACCOMPLISHMENTS BN 2023-2024

- Adopted a 5-year action plan for FY 2023-2027
- Worked with the MRC Community Advisory Committee to develop competitive grant framework for the urban renewal area economic development programs (i.e., storefront improvement, tenant improvement, etc.)
- Issued debt through a general obligation bond of \$5,052,000 to begin implementing capital improvement projects outlined in the 5-year action plan.

PRIORITIES BN 2025-2026



Seek best practices and expertise from other public agencies and establish agreements with implementation partners



Utilize increment funds to implement economic development-related programs



Complete, and/or financially obligate, the bonded capital improvement projects that are called out in the five-year action plan



FINANCIAL SUMMARY – MILWAUKIE REDEVELOPMENT COMMISSION FUND

(Amounts in Thousands: \$100 = \$100,000)

	HISTORICAL		BN 2023-2024 CURRENT OUTLOOK				BN 2025-2026			
	Actual FY 2021	Actual FY 2022	Amended Budget	Actual FY 2023	Estimated FY 2024	Estimated BN Total	Proposed Total	Approved FY 2025	Approved FY 2026	Approved Total
RESOURCES										
BEGINNING FUND BALANCE	513	990	2,339	1,491	6,665	1,491	7,483	7,483	5,134	7,483
Property Taxes	470	504	1,753	590	745	1,335	1,753	790	963	1,753
Interest Income	7	4	10	154	78	232	10	5	5	10
Miscellaneous	-	1	-	1	-	1	-	-	-	-
Proceeds from Issuance of Debt	-	-	6,500	5,052	-	5,052	-	-	-	-
TOTAL RESOURCES	\$ 990	\$ 1,499	\$ 10,602	\$ 7,288	\$ 7,488	\$ 8,111	\$ 9,246	\$ 8,278	\$ 6,102	\$ 9,246
REQUIREMENTS										
PERSONNEL SERVICES										
Salaries	-	-	-	-	-	-	-	-	-	-
Benefits	-	-	-	-	-	-	-	-	-	-
TOTAL PERSONNEL SERVICES	-	-	-	-	-	-	-	-	-	-
MATERIALS & SERVICES										
Professional & Technical Services	-	8	100	25	5	30	600	300	300	600
TOTAL MATERIALS & SERVICES	-	8	100	25	5	30	600	300	300	600
Capital Outlay	-	-	5,332	206	-	206	5,182	2,482	2,700	5,182
Debt Service	-	-	1,044	357	-	357	674	337	337	674
Transfer to Other Funds	-	-	70	35	-	-	50	25	25	50
Contingency	-	-	42	-	-	-	-	-	160	160
TOTAL PROGRAM REQUIREMENTS	-	8	6,588	623	5	593	6,506	3,144	3,522	6,666
Unappropriated Ending Fund Balance	990	1,491	4,014	6,665	7,483	7,518	2,740	5,134	2,580	2,580
TOTAL REQUIREMENTS	\$ 990	\$ 1,499	\$ 10,602	\$ 7,288	\$ 7,488	\$ 8,111	\$ 9,246	\$ 8,278	\$ 6,102	\$ 9,246

	Actual FY 2021	Actual FY 2022	Amended Budget	Actual FY 2023	Estimated FY 2024	Estimated BN Total	Proposed Total	Approved FY 2025	Approved FY 2026	Approved Total
POLICY REQUIREMENTS										
Contingency & Ending Fund Balance Above	990	1,491	4,056	6,665	7,483	7,518	2,740	5,134	2,740	2,740
Policy Requirement (50%)	-	-	90	30	-	20	320	160	160	320
AMOUNT OVER (UNDER) POLICY REQUIREMENT	\$ 990	\$ 1,491	\$ 3,966	\$ 6,635	\$ 7,483	\$ 7,498	\$ 2,420	\$ 4,974	\$ 2,580	\$ 2,420

FIVE-YEAR FORECAST

MILWAUKIE REDEVELOPMENT DISTRICT / URBAN RENEWAL AUTHORITY SUMMARY

(Amounts in Thousands; \$ 100 = \$ 100,000)

	FY 2021		FY 2022		FY 2023		Current Fiscal Year Estimated FY 2024		Current Budget FY 2025		Current Budget FY 2026		Forecast FY 2027		Forecast FY 2028		Forecast FY 2029		ASSUMPTIONS
RESOURCES																			
BEGINNING FUND BALANCE	\$	513	\$	990	\$	1,491	\$	6,665	\$	7,483	\$	5,134	\$	7,483	\$	6,788	\$	6,081	
REVENUES																			
Property Taxes		470		504		590		745		790		963		1,146		1,341		1,546	Projected Analysis
Interest Income		7		4		154		78		5		5		5		5		5	3%
Proceeds from Issuance of Debt		-		-		5,052		-		-		-		-		-		-	
TOTAL REVENUES		477		508		5,796		823		795		968		1,151		1,346		1,551	
TOTAL RESOURCES	\$	990	\$	1,498	\$	7,287	\$	7,488	\$	8,278	\$	6,102	\$	8,634	\$	8,134	\$	7,633	
REQUIREMENTS																			
EXPENDITURES																			
Materials & Services		-		8		25		5		300		300		309		318		328	3%
Capital Outlay		-		-		206		-		2,482		2,700		1,000		1,000		1,000	Capital Improvement Plan
Debt Service		-		-		357		-		337		337		337		522		522	Estimated
Transfers to Other Funds		-		-		-		-		25		25		46		54		62	4% Administration Fee of TIF
Contingency		-		8		623		-		-		-		155		159		164	50% Contingency of M & S plus transfers
TOTAL EXPENDITURES		-		16		1,211		5		3,144		3,362		1,846		2,053		2,076	
FUND BALANCE																			
Policy Requirement (50%)		-		-		30		-		160		160		320		160		160	
Over (Under) P Policy		990		1,482		6,046		7,483		4,974		2,580		6,468		5,921		5,397	
TOTAL ENDING FUND BALANCE		990		1,482		6,076		7,483		5,134		2,740		6,788		6,081		5,557	
TOTAL REQUIREMENTS	\$	990	\$	1,498	\$	7,287	\$	7,488	\$	8,278	\$	6,102	\$	8,634	\$	8,134	\$	7,633	





CITY OF MILWAUKIE



APPROVED CAPITAL IMPROVEMENT PLAN

Fiscal Years 2025-2030



RS324

TABLE OF CONTENTS

Message from the city manager	1
Document Guide	2
Abbreviations	3
CIP Overview	4
Fund Summary Information	5
Multi-Document Transparency	7
CIP Project Process	8
Chapter 1: Infrastructure	
Funding Overview	9
Summary by Project Totals	11
Summary by Department	14
Project Summaries	23
Chapter 2: Operational Facilities and Equipment	
Overview	87
Summary by Project & Fund	88
Project Summaries	90
Chapter 3: Urban Renewal Authority	
Narrative & Fund Table.....	109
Project Summaries	110
Chapter 4: Unfunded	
Narrative & Summary by Project Totals	119
Project Summaries	120
Special Thanks	131



RS326



MESSAGE FROM THE CITY MANAGER

The enclosed Capital Improvement Plan (CIP) represents the city's commitment to building and maintaining the infrastructure that allows Milwaukie to thrive. The projects included are derived from the city's various system plans, which reflect industry best practice, assessments of current condition and need, and community input. To prepare the five-year CIP, staff align these plans' project lists and sort them by year according to priority and fund availability. Wherever possible, the city identifies ways multiple infrastructure system upgrades can be delivered in a single project to reduce construction impacts and overall costs.

Over the past biennium, we made significant progress delivering the city's CIP as supply chain and labor shortage issues eased. Construction wrapped up on improvements to Home and Wood Avenues as well as the segment of the Monroe Greenway between 34th and 37th Avenues (delivered as part of the Seven Acres Apartments project). We kicked off construction on the Meek Street, Washington Street Area, and Bowman-Brae, Balfour, and Scott Park improvement projects. Engineering design work also progressed on the Ardenwald North and Harvey Street improvement projects, setting them up for construction in this biennium. City staff have also continued supporting the Kellogg Creek Restoration and Dam Removal Project, with sediment sampling beginning this summer and design work underway. On the operational facilities and equipment side, we completed renovations at the new city hall and Johnson Creek campus, installed additional electric vehicle charging stations at the four primary city locations, and kicked-off of seismic retrofit work at the public safety building. Finally, upgrades to the city's supervisory control and data acquisition (SCADA) system are almost complete.

For this budget, staff have calibrated our CIP to reflect what can be realistically delivered over the coming years. The city's capital investment priorities for this biennium are as follows:

- **Sustain momentum delivering Safe Access for Everyone (SAFE) and Street Surface Maintenance Program (SSMP) projects:** We are poised to complete improvements on Harvey Street, Ardenwald North, Washington Street and King Road as we continue spending down the second tranche of debt financing for SAFE and SSMP projects. The city will also launch the SAFE spot improvement program in FY 2025.
- **Begin major investments in water infrastructure upgrades:** After several years focused on transportation improvements, this CIP shifts significant dollars toward critical water improvements, including more than \$10 million from the water utility fund in FY 2025 and 2026. These improvements include upgrades at several of the city's wells, completion of the rehabilitation of the Stanley reservoir, and funding for planning and design work for future water treatment plant upgrades and storage reservoir.
- **Invest capital dollars into improvements and programs within the Urban Renewal Area (URA):** The coming biennium will see the first round of significant capital investment in the URA following the adoption of the five-year action plan in 2023. Projects will include downtown street enhancements, upgrades to crosswalks across McLoughlin Boulevard, reconfiguration of parking at Milwaukie Bay Park, and integration of Dogwood Park into the new built environment in South Downtown.

As noted in our citywide budget message, Milwaukie's general fund faces critical revenue shortfalls over the five-year forecast. Given that, the city has been forced to delay some general funded CIP projects, including deconstruction of the Bertman House, aesthetic upgrades at the public safety building, and accessibility improvements at city facilities.

Despite these resource constraints, this CIP continues to build out networks of safe and reliable infrastructure. It is a downpayment on the community's vision that will continue to serve Milwaukie for decades to come. Looking forward, many of the plans and programs that generate the project list in the CIP are coming up on being a decade or more old. We plan to engage the community during this biennium to recalibrate infrastructure priorities and ensure our future decision-making criteria aligns with our community's greatest needs. We look forward to the conversations to come.

Sincerely,

Emma Sagor
Acting City Manager

DOCUMENT GUIDE

This Capital Improvement Plan (CIP) document provides detailed descriptions about projects organized by fund. Each fund section begins with a summary overview of the function of the fund followed by funding and project information. Summary tables and graphs highlight the capital projects within each fund. Following the summary sections are detailed breakdowns of each project, along with project schedules, cost estimates, and operating budget impacts.

Summary information of all capital projects sorted by fund, funding source, and funding status are included as appendices to this document.

The project title and description explain the details and need for each project



Pump Station Improvements

Wastewater Improvements: These planned pump station upgrade projects consist of electrical and pumping upgrades for any equipment that has become obsolete and for which replacement parts are no longer available, or where reliability, efficiency, or accuracy has degraded below acceptable levels. Mechanical pumping equipment may consist of replacing pump station equipment to improve efficiency.

Describes the outcome of the project on the operating budget of each fund

Operating Budget Impact: Completing preventative maintenance should reduce operating and emergency expenditures.

Key Departments: Public Works

The requesting department(s)

	FY 2025	FY 2026	FY 2027	FY 2028	TOTAL
Capital Cost:					
Planning, Engineering, Design	\$		248,000		\$ 248,000
Construction				460,000	460,000
TOTAL ESTIMATED CAPITAL COST	\$		248,000	460,000	\$ 708,000
Funding Source:					
Wastewater			\$ 248,000	\$ 460,000	\$ 708,000
TOTAL FUNDING	\$		\$ 248,000	\$ 460,000	\$ 708,000

This section indicates the project's estimated capital cost and the funding source(s) of the project, and cost for each scheduled project year

ABBREVIATIONS

ADA	Americans with Disabilities Act	LIDA	Low Impact Development Approach
ARPA	American Rescue Plan Act	MH	Manhole
BPAP	Bicycle and Pedestrian Accessibility Program	NMIA(P)	North Milwaukie Innovation Area (Plan)
CCSD	Clackamas County Service District #1	ODOT	Oregon Department of Transportation
CCTV	Close Circuit Television	PCC	Precision Castparts Corporation
CDBG	Community Development Block Grant	PCI	Pavement Condition Index
CIPP	Cured-in-Place-Pipe	RFFA	Regional Flexible Funding Allocation
CMLUTP	Central Milwaukie Land Use and Transportation Plan	ROW	Right-of-Way
CO	Cleanout	RRFB	Rectangular Rapid Flash Beacon
CRW	Clackamas River Water District	RTP	Regional Transportation Plan
CUAB	Citizens Utility Advisory Board	SAFE	Safe Access for Everyone
DEQ	Department of Environmental Quality	SCADA	Supervisory Control and Data Acquisition
FEMA	Federal Emergency Management Agency	SDC	System Development Charge
FILOC	Fee in Lieu of Construction	SSMP	Street Surface Maintenance Program
FRA	Federal Railroad Administration	SWMP	Stormwater Master Plan
FY	Fiscal Year	TSP	Transportation Systems Plan
GIS	Geographic Information System	UGMA	Urban Growth Management Area
GPM	Gallons Per Minute	UIC	Underground Injection Control
HDPE	High-Density Polyethylene	URA(P)	Urban Renewal Area (Plan)
HMA	Hazard Mitigation Assistance	WPCF	Water Pollution Control Facility
I&I	Inflow & Infiltration	WMP	Water Master Plan
JCB	Johnson Creek Boulevard Campus	WWMP	Wastewater Master Plan

CAPITAL IMPROVEMENT PLAN OVERVIEW

The Capital Improvement Plan (CIP) establishes guidance and planning for the City of Milwaukie's capital investments in fleet, facilities, and infrastructure. At its foundation, the CIP is the City's master plan documents (Water, Wastewater, Stormwater, Transportation, and Parks), which are an extension of the City's Comprehensive Plan. These master plans illustrate the long-term needs and goals of each department as defined by community input, advisory groups, expert consultants, and city staff. Planning Commission and City Council goals, operational (i.e., service delivery) needs, and regulatory requirements further refine and shape the CIP.

Projects within the CIP are prioritized and matched with projections of future revenues. Inclusion of a project within this document does not necessarily reflect a budgeted spending commitment, but instead reflects the current anticipated priorities based on estimated future revenues. Current revenues are not enough to keep up with all the capital needs of the City, and as such, some projects

are shown as unfunded or partially funded in the CIP. Additionally, there are restrictions related to where the funds may be spent on many revenue sources.

A capital expenditure is defined by the City using the following criteria: relatively high monetary value (\$10,000 or greater), and a long asset life (1 or more years of useful life), excluding the cost of normal maintenance and repairs that do not add to the asset's value or partially extend the asset's life.

The CIP is intended as a method of communication with residents, businesses, advisory groups, Planning Commission, and City Council. It gives the public the opportunity to see the City's proposed plans and provide feedback to City Council and city staff.

The goal of this CIP is to provide the maximum sustainable level of priority capital investment to deliver outcomes that are of the highest importance to our residents and provide for a healthy, safe, active, efficient, and optimized community with excellent livability and quality of life.

FACTORS IN EVALUATING CIP PROJECTS

- Master planning documents
- City Council & Planning Commission goals
- Operational needs
- Regulatory requirements
- Fiscal impacts
- Health, safety, and environmental effects
- Community economic effects
- Implications of deferring the project
- Coordination and advantages of joint projects
- Feasibility, including public support and disruption

FUNDING FOR CAPITAL PROJECTS COMES FROM FOUR DISTINCT SOURCES

1. **FEES:** including utility rates, franchise utility fees, state gas tax and vehicle registration fees, interest income, streets/parks fees, and property taxes.
2. **BONDS**
3. **GRANTS AND INTERGOVERNMENTAL:** from outside agencies such as ODOT, Metro, Clackamas County, DEQ, and Oregon Parks.
4. **DEVELOPMENT:** funds paid by new development to cover the cost of the development's impact to the systems either by their request or as a condition of development.

FUNDING SUMMARY INFORMATION

TOTAL PROJECTS BY FUND

(Amounts in Thousands: \$100 = \$100,000)

FUND	FY 2025	FY 2026	FY 2027	FY 2028	FY 2029	FY 2030	TOTAL
General							
Infrastructure	\$ 1,070						\$ 1,070
Operations	1,750	412	1,706	505	990	360	5,723
Urban Renewal Authority		60					60
Total General Fund	\$ 2,820	472	1,706	505	990	360	\$ 6,853
Building							
Operations	\$ 50	50					\$ 100
Total Building Fund	\$ 50	50					\$ 100
Transportation							
Infrastructure	\$ 13,275	12,723	1,800	9,729	5,291	3,539	\$ 46,357
Operations	141	123	100	50	150	50	614
Total Transportation Fund	\$ 13,416	12,846	1,900	9,779	5,441	3,589	\$ 46,971
System Development Charges (SDC)							
Infrastructure	\$ 945	185					\$ 1,130
Total SDC Fund	\$ 945	185					\$ 1,130
Water							
Infrastructure							
Operations	\$ 7,544	2,535	1,934	7,991	7,939	11,422	\$ 39,365
Total Water Fund	\$ 7,544	2,535	1,934	7,991	7,939	11,422	\$ 39,365

TOTAL PROJECTS BY FUND (CONTINUED)

(Amounts in Thousands: \$100 = \$100,000)

FUND	FY 2025	FY 2026	FY 2027	FY 2028	FY 2029	FY 2030	TOTAL
Wastewater							
Infrastructure	\$ 4,594	1,645	727	637	511	942	\$ 9,056
Operations	486		165	115	535	500	1,801
Total Wastewater Fund	\$ 5,080	1,645	892	752	1,046	1,442	\$ 10,857
Stormwater							
Infrastructure	\$ 8,047	971	318	1,465	1,035	2,218	\$ 14,054
Operations	\$ 256	885	205	295	450	550	2,641
Total Stormwater Fund	\$ 8,303	1,856	523	1,760	1,485	2,768	\$ 16,695
Urban Renewal Authority							
Infrastructure	332	1,000					\$ 1,332
Operations							
Urban Renewal Authority	2,150	1,700	1,000				4,850
Total URA Fund	\$ 2,482	2,700	1,000				\$ 6,182
CITYWIDE TOTALS	\$ 40,640	22,289	7,955	20,787	16,901	19,581	\$ 128,153

MULTI-DOCUMENT TRANSPARENCY

The City of Milwaukee recognizes that the projects included in the Capital Improvement Plan represent a significant amount of public monies and it is the City's intention to present this information across several documents to ensure that projects are clearly understood and accounted for in financial forecasts, budgets, capital improvement plans, and master plans.

Multi-document transparency means that a capital project necessitated by a master plan will be included in the CIP document and then planned for in the forecast document. Funding for the project will then be included in the budget document and the expense will be recorded in quarterly and annual financial reports.



FINANCIAL REPORTING

Projects funded within the CIP are reported as "Capital Outlay" in financial forecasts, budgets, quarterly reports, and annual reports. This line item corresponds with the annual funded totals shown in this CIP.

The adoption of this CIP document provides the baseline for Capital Outlay that will be included in future budget documents for the Budget Committee to review, consider, and approve, and for the City Council to formally adopt.

System Development Charges Fund Summary											
<i>(Amounts in Thousands: \$100 = \$100,000)</i>											
	Actual FY 2019	Actual FY 2020	BN 2021-2022 CURRENT OUTLOOK				BN 2023-2024				
			Budget	Actuals FY 2021	Estimated FY 2022	Estimated Total	Proposed Total	Approved Total	Adopted Biennial Budget		
									FY 2023	FY 2024	Total
RESOURCES											
BEGINNING FUND BALANCE	\$ 1,529	\$ 1,840	\$ 2,003	\$ 1,775	\$ 1,700	\$ 1,775	\$ 2,152	\$ 2,152	\$ 2,152	\$ 1,961	\$ 2,152
System Development Charges	508	208	711	172	1,101	1,273	1,396	1,396	904	492	1,396
Intergovernmental	-	-	-	-	-	-	250	250	250	-	250
Interest Income	34	36	40	10	2	12	10	10	5	5	10
Transfers In	-	-	23	23	-	23	-	-	-	-	-
TOTAL RESOURCES	\$ 2,071	\$ 2,084	\$ 2,777	\$ 1,980	\$ 2,803	\$ 3,083	\$ 3,808	\$ 3,808	\$ 3,311	\$ 2,458	\$ 3,808
REQUIREMENTS											
Materials & Services	-	-	-	-	-	-	550	550	400	150	550
Capital Outlay	231	309	1,939	280	651	931	1,560	1,560	950	610	1,560
Contingency	-	-	260	-	-	-	130	130	-	130	130
TOTAL PROGRAM REQUIREMENTS	231	309	2,199	280	651	931	2,240	2,240	1,350	890	2,240
Unappropriated Ending Fund Balance	1,840	1,775	578	1,700	2,152	2,152	1,568	1,568	1,961	1,568	1,568
TOTAL REQUIREMENTS	\$ 2,071	\$ 2,084	\$ 2,777	\$ 1,980	\$ 2,803	\$ 3,083	\$ 3,808	\$ 3,808	\$ 3,311	\$ 2,458	\$ 3,808

THE PROCESS OF A CIP PROJECT

QUESTION: How does a project get placed in the Capital Improvement Plan?

ANSWER: Resident involvement is the cornerstone of the Capital Improvement Plan. Projects are vetted through a multi-step process (see below) that includes public comment at several stages to ensure that projects meet the community's needs, in addition to expert analyses during plan development. Projects do not begin until funding has been confirmed, approved, and adopted into the City's biennial budget.

START



1. A project is first considered as part of the planning process. City staff, with the assistance of expert consultants and resident advisory group members, drafts master plans for community consideration.
2. Master plans are subject to several community meetings where residents are invited to review the plan scope and corresponding capital projects required to fulfill the plan.
3. Planning Commission reviews master plans and takes public comments. The Planning Commission carefully considers the community vision when determining whether to recommend a master plan.
4. City Council then reviews master plans and adopts them. Once adopted, a master plan becomes the guiding document for that City function and the associated project list required to fulfill the master plan.
5. Staff reviews other Council adopted plans such as individual parks master plans, greenway plans, and other similar documents for inclusion in the CIP.
6. Staff tracks resident input, regulatory requirements, and infrastructure needs to refine the list of capital needs and prioritization of projects within the CIP.
7. Budget Committee reviews and recommends revisions as part of the biennial budget process. City Council adopts the CIP with the biennial budget.
8. As projects commence, public outreach efforts will focus on impacted neighbors to ensure that project work meets the needs of the community within the adopted Council plan and has a minimal impact on services and the community. The City's website is the primary communications vehicle.

COMPLETION

CHAPTER 1

INFRASTRUCTURE

FUNDING OVERVIEW

The tables on the next page list projects that are funded with the following sources. Most of the sources are constrained, meaning that they can only be used for a specific function like expanding the system's capacity, paving streets, building sidewalk or bicycle facilities, or developing parks. The funds also flow into Milwaukie from a variety of sources, most of which are tax-based and administered through different levels of government and mechanisms.

GENERAL

GENERAL: The General Fund identifies infrastructure improvements and amenities that enhance the economic vitality and livability of the community. Projects may include potential parks improvements, new community facilities, and economic development programming.

TRANSPORTATION

SAFE: Safe Access for Everyone (SAFE) is the city's program to improve safety for people walking, biking and more. SAFE calls for upgrading the city's network of connections, such as sidewalks, ramps, and crossings to fill network gaps, replace portions that don't meet Americans with Disabilities Act (ADA) standards, and remove barriers for people to get where they need to go safely. The SAFE fee is collected as a part of city utility bills and the amount is based on the way the property is utilized.

SSMP: The Street Surface Maintenance Program (SSMP) improves and maintains the state of Milwaukie's streets. The engineering department maintains a database of overall Pavement Condition Index (PCI) for all city streets and updates the database each year to include all constructed or reconstructed projects. A newly paved street has a PCI of 100; the original SSMP goal was to obtain an average PCI value of 75 for arterial and collector streets. In 2016, CUAB approved incorporating residential streets into the SSMP. The City street network has approximately 148 miles of roadway. The SSMP fee is collected as part of city utility bills and the amount is based on the way the property is utilized.

Gas Tax: State gas taxes are collected by the state. The state retains 50% of funds and then distributes the remainder to counties and cities in a 30/20 split. State gas tax funds must be spent on improvements to roads and cannot be used for trails or other improvements outside of road right-of-way.

Grants (state and federal): The city regularly applies for grants to fund transportation projects. During the time period covered by this CIP, the city will be utilizing federal and state funds awarded by Metro Regional government and the Oregon Department of Transportation.

Transportation System Development Charges (SDC): Transportation SDCs are calculated based on the expected impact of new development on the transportation system. SDCs can be used to expand the transportation system but cannot be used for ongoing maintenance.

Vehicle Registration Fees: Clackamas County began collecting vehicle registration fees in 2019. A portion of the funding collected, based on population, is provided directly to the city to maintain or invest in city projects. These funds are constrained by the same limitations as the state gas tax and therefore must be used on roads.

WATER

Usage Charges: The city periodically conducts rate studies to determine its revenue requirements for operations and capital improvements related to its water system. The most recent study was completed, and recommendations adopted by City Council in June 2022. The services are billed monthly and for each water customer there is fixed charge based on meter size and a usage fee based on 100 cubic feet of water (CCF).

SDC: The system development charge is a one-time fee imposed on new development at the time of development. The fee is intended to recover a fair share of the costs of existing and planned facilities that provide capacity to serve growth. The water SDC is the sum of the reimbursement fee and improvement fee.

WASTEWATER

Usage Charges: The city periodically conducts rate studies to determine its revenue requirements for operations and capital improvements related to its wastewater system. The most recent study was completed, and recommendations adopted by City Council in June 2022. The services are billed monthly and for each wastewater customer there is fixed charge based on meter size, a usage fee based on 100 CCF based on the winter average usage and a treatment fee based on an equivalent dwelling unit (EDU).

SDC: The system development charge is a one-time fee imposed on new development at the time of development. The fee is intended to recover a fair share of the costs of existing and planned facilities that provide capacity to serve growth. The wastewater SDC is the sum of the reimbursement fee and the improvement fee adjusted by an administrative cost recovery factor.

STORMWATER

Usage Charges: The city periodically conducts rate studies to determine its revenue requirements for operations and capital improvements related to its stormwater system. The most recent study was completed, and recommendations adopted by City Council in 2014. The services are billed monthly and single-family residential customers are billed a flat fee. Commercial customers fees are calculated based on the amount impervious surface area.

SDC: The system development charges are a one-time fee imposed on new growth and increased development to recover the cost of system facilities needed to serve that growth. The fee is intended to recover a fair share of the costs of existing and planned facilities that provide capacity to serve growth. The stormwater SDC is the sum of the reimbursement fee and improvement fee. A single stormwater unit represents the stormwater service needs of an average single-family residence.

PAGE	PROJECT NAME	GENERAL	SSMP	SAFE	TRANSPORTATION	SDCS	WATER	WASTEWATER	STORMWATER	URBAN RENEWAL AUTHORITY	OTHER FUNDING NOT IN CITY BUDGET	TOTAL
23	26th Avenue Improvements	\$	88	74								\$ 162
24	3rd Zone Pump Station Improvements						1,250					1,250
25	40th and Harvey Concrete Reservoir						850					850
26	44th Avenue - Water System Improvements						240					240
27	Additional Water Rights Evaluation						50					50
28	Ardenwald North Improvements		592	765	232		995	745	691			4,020
29	Ardenwald South Improvements		1,175	2,292			755		304			4,526
30	Balfour Park	364										364
31	Bowman-Brae Park	340		25								365
32	Bowman Brae & Where Else Lane			25								25
32	Brookside Pump Station Improvements							500				500
33	Downtown Curbs & Storm				55				500			555
33	Downtown Public Area Requirements					250						250
34	Elk Street Water System Improvements						252					252
35	Firwood Street - Water System Improvements						511					511
35	Flavel Drive - Water System Improvements						280					280
36	Flood Mitigation Grant Match								300			300
37	Harvey Street Improvements		958	890	822		1,600	87	663			5,020
38	International Way Improvements		514	1,956			256	312	524			3,562
39	Johnson Creek Siphon Inspection							110				110
40	King Road Improvements (40th - 42nd)		134	418			855					1,407
41	King Road Improvements (43rd - Linwood)		1,571	4,026			602		2,000			8,199
42	Lava Drive Booster Pump Station						175					175
42	Lead Service Line Replacements						300					300
43	Logus Road, 40th & 42nd Avenue		2,952	1,157	2,300		1,580	108	672			8,769
44	Manhole Surveying							75				75

PAGE	PROJECT NAME	GENERAL	SSMP	SAFE	TRANSPORTATION	SDCS	WATER	WASTEWATER	STORMWATER	URBAN RENEWAL AUTHORITY	OTHER FUNDING NOT IN CITY BUDGET	TOTAL
45	McLoughlin - Water System Improvements	\$					700					\$ 700
46	Meek Street Improvements								3,381			3,381
47	Miscellaneous Equipment Replacement and Upgrades						60					60
48	Monroe Street & Mullan Street Pipe Extension						409					409
49	Monroe Street Greenway				2,808		250		636	1,332	3,148	8,174
50	New Storage Reservoir						8,550					8,550
51	North Milwaukee Downtown Improvements		708	581				485	712			2,486
52	Oatfield Road & Shell Lane Improvements		37	23			19		49			128
53	Park Street & Lloyd Street Improvements		186	138			350	77	168			919
54	Pipeline Rehabilitation & Replacement							766				766
55	Plum, Apple, & Hemlock Streets								1,375			1,375
56	Pump Station Condition Assessments							30				30
56	Pump Station Improvements							708				708
57	Pump Station Lift & SCADA Controls Replacement							50				50
57	Residential Street Surface Repair		1,000		2,000							3,000
58	Rio Vista Street - Water System Improvements						993					993
58	SAFE Spot Program			350								350
59	Salt & Rock Cover				125							125
60	Scott Park	366										366
61	Sewer Lining Projects							1,359				1,359
62	Signal and Intersection Upgrades				600							600
63	Sparrow Street Improvements		89	58			85		67			299
64	Stanley Reservoir Improvements						2,600					2,600
65	Stanley SAFE Improvements			5,500	500							6,000
66	Stormwater Capital Maintenance Program								1,500			1,500
67	Stormwater System Plan					310						310

PAGE	PROJECT NAME	GENERAL	SSMP	SAFE	TRANSPORTATION	SDCS	WATER	WASTEWATER	STORMWATER	URBAN RENEWAL AUTHORITY	OTHER FUNDING NOT IN CITY BUDGET	TOTAL
68	Street Surface Slurry Seal	\$	1,000		1,250							\$ 2,250
69	Transportation Capital Maintenance Program				3,000							3,000
70	Transportation System Plan					250						250
71	VFD Improvements						150					150
72	Washington Street Area Improvements		1,588	1,000	377		100	100	500			3,665
73	Wastewater Capital Maintenance Program							300				300
74	Water Automation and Control Upgrades						320					320
74	Water Capital Maintenance Program						600					600
75	Water Pressure Zone Analysis						50					50
75	Water System Intertie Evaluation						475					475
76	Water Transfer Pump Upgrades						1,650					1,650
77	Water Transmission Main Replacement						1,786					1,786
77	Water Treatment Plant						8,050					8,050
78	Waverly Heights Sewer System Reconfiguration					320		3,042				3,362
79	Waverly South Improvements		359	84			162	202	12			819
80	Well 4 Reconditioning						60					60
81	Well 5 Improvements						650					650
82	Well 6 Pump Station Improvements						50					50
83	Well 6 & 7 Reconditioning Project						120					120
84	Well 8						300					300
84	Well House HVAC Upgrades						150					150
85	Winworth Court - Water System Improvements						125					125
TOTAL		\$1,070	12,951	19,362	14,069	1,130	39,365	9,056	14,054	1,332	3,148	\$ 115,537

GENERAL FUND & URBAN RENEWAL AUTHORITY

PAGE	FUND	FY 2025	FY 2026	FY 2027	FY 2028	FY 2029	FY 2030	TOTAL
15	General Fund Public Works Admin - Balfour, Bowman-Brae & Scott Parks	\$ 1,070,000						\$ 1,070,000
49	Urban Renewal Authority - Monroe Street Greenway	332,000	1,000,000					1,332,000
TOTAL GENERAL & URA FUNDS		\$ 1,402,000	1,000,000					\$ 2,402,000

TRANSPORTATION

PAGE	FUND	FY 2025	FY 2026	FY 2027	FY 2028	FY 2029	FY 2030	TOTAL
16	SSMP	\$ 3,856,000	2,952,000	568,000	3,319,000	1,322,000	934,000	\$ 12,951,000
17	SAFE	7,194,000	5,602,000	132,000	3,060,000	2,369,000	1,005,000	19,362,000
18	State Gas Tax (Transportation)	2,250,000	4,169,000	1,100,000	3,350,000	1,600,000	1,600,000	14,069,000
TOTAL TRANSPORTATION FUND		\$13,300,000	12,723,000	1,800,000	9,729,000	5,291,000	3,539,000	\$ 46,382,000

SYSTEM DEVELOPMENT CHARGES

PAGE	FUND	FY 2025	FY 2026	FY 2027	FY 2028	FY 2029	FY 2030	TOTAL
19	Transportation SDC	\$ 500,000						\$ 500,000
19	Wastewater SDC	170,000	150,000					320,000
19	Stormwater SDC	275,000	35,000					310,000
TOTAL SDC FUND		\$ 945,000	185,000					\$ 1,130,000

UTILITY FUNDS

PAGE	FUND	FY 2025	FY 2026	FY 2027	FY 2028	FY 2029	FY 2030	TOTAL
20	Water	\$ 7,544,000	2,535,000	1,934,000	7,991,000	7,939,000	11,422,000	\$ 39,365,000
21	Wastewater	4,594,000	1,645,000	727,000	637,000	511,000	942,000	9,056,000
22	Stormwater	8,047,000	971,000	318,000	1,465,000	1,035,000	2,218,000	14,054,000
TOTAL UTILITY FUNDS		\$20,185,000	5,151,000	2,979,000	10,093,000	9,485,000	14,582,000	\$ 62,475,000
TOTAL INFRASTRUCTURE (MULTIPLE FUNDS)		\$35,832,000	19,059,000	4,779,000	19,822,000	14,776,000	18,121,000	\$ 112,389,000

AMERICAN RESCUE PLAN ACT (ARPA) PARKS - FEDERAL GRANT

PAGE	PROJECT NAME	FY 2025	FY 2026	FY 2027	FY 2028	FY 2029	FY 2030	TOTAL
30	Balfour Park	\$ 204,000						\$ 204,000
31	Bowman-Brae Park	267,000						267,000
60	Scott Park	202,000						202,000
SUBTOTAL ARPA PARKS GRANT FUNDS		\$ 673,000						\$ 673,000

METRO PARKS BOND - NATURE IN NEIGHBORHOODS GRANT

PAGE	PROJECT NAME	FY 2025	FY 2026	FY 2027	FY 2028	FY 2029	FY 2030	TOTAL
30	Balfour Park	\$ 87,000						\$ 87,000
31	Bowman-Brae Park	41,000						41,000
60	Scott Park	30,000						30,000
SUBTOTAL METRO PARKS BOND NIN GRANT		\$ 158,000						\$ 158,000

METRO PARKS BOND - LOCAL SHARE ALLOCATION GRANT

PAGE	PROJECT NAME	FY 2025	FY 2026	FY 2027	FY 2028	FY 2029	FY 2030	TOTAL
30	Balfour Park	\$ 73,000						\$ 73,000
31	Bowman-Brae Park	32,000						32,000
SUBTOTAL METRO PARKS BOND NIN GRANT		\$ 105,000						\$ 105,000

OREGON STATE PARKS LOCAL GOVERNMENT GRANT PROGRAM (LGGP)

PAGE	PROJECT NAME	FY 2025	FY 2026	FY 2027	FY 2028	FY 2029	FY 2030	TOTAL
60	Scott Park	\$ 134,000						\$ 134,000
SUBTOTAL OREGON LGGP GRANT		\$ 134,000						\$ 134,000
TOTAL GENERAL FUND - GRANTS		\$ 1,070,000						\$ 1,070,000

TRANSPORTATION - SSMP PROJECT SUMMARY

PAGE	PROJECT NAME	FY 2025	FY 2026	FY 2027	FY 2028	FY 2029	FY 2030	TOTAL
23	26th Avenue Improvements	\$ 88,000						\$ 88,000
28	Ardenwald North Improvements	592,000						592,000
37	Harvey Street Improvements	479,000	479,000					958,000
57	Residential Street Surface Repair	500,000	500,000					1,000,000
68	Street Surface Slurry Seal	250,000	250,000	500,000				1,000,000
72	Washington Street Area Improvements	1,588,000						1,588,000
79	Waverly South Improvements	359,000						359,000
41	King Road Improvements (43rd - Linwood)		1,571,000					1,571,000
43	Logus Road, 40th & 42nd Avenue		152,000		2,800,000			2,952,000
38	International Way Improvements			68,000	446,000			514,000
29	Ardenwald South Improvements				68,000	1,107,000		1,175,000
63	Sparrow Street Improvements				5,000	84,000		89,000
40	King Road Improvements (40th - 42nd)					21,000	113,000	134,000
51	North Milwaukee Downtown Improvements					110,000	598,000	708,000
52	Oatfield Road & Shell Lane Improvements						37,000	37,000
53	Park Street & Lloyd Street Improvements						186,000	186,000
TOTAL TRANSPORTATION FUND - SSMP		\$ 3,856,000	2,952,000	568,000	3,319,000	1,322,000	934,000	\$12,951,000

TRANSPORTATION - SAFE PROJECT SUMMARY

PAGE	PROJECT NAME	FY 2025	FY 2026	FY 2027	FY 2028	FY 2029	FY 2030	TOTAL
23	26th Avenue Improvements	\$ 74,000						\$ 74,000
28	Ardenwald North Improvements	765,000						765,000
31	Bowman-Brae Park	25,000						25,000
32	Bowman Brae & Where Else Lane	25,000						25,000
37	Harvey Street Improvements	445,000	445,000					890,000
41	King Road Improvements (43rd - Linwood)	4,026,000						4,026,000
58	SAFE Spot Program	250,000	100,000					350,000
72	Washington Street Area Improvements	1,000,000						1,000,000
79	Waverly South Improvements	84,000						84,000
43	Logus Road, 40th & 42nd Avenue		57,000		1,100,000			1,157,000
38	International Way Improvements			132,000	1,824,000			1,956,000
29	Ardenwald South Improvements				132,000	2,160,000		2,292,000
63	Sparrow Street Improvements				4,000	54,000		58,000
40	King Road Improvements (40th - 42nd)					65,000	353,000	418,000
51	North Milwaukie Downtown Improvement:					90,000	491,000	581,000
52	Oatfield Road & Shell Lane Improvements						23,000	23,000
53	Park Street & Lloyd Street Improvements						138,000	138,000
SUBTOTAL TRANSPORTATION FUND - SAFE		\$ 6,694,000	602,000	132,000	3,060,000	2,369,000	1,005,000	\$ 13,862,000

SRTS & COUNTY URA

PAGE	PROJECT NAME	FY 2025	FY 2026	FY 2027	FY 2028	FY 2029	FY 2030	TOTAL
65	Stanley SAFE Improvements	\$ 500,000	5,000,000					\$ 5,500,000
SUBTOTAL SRTS/COUNTY GRANT		\$ 500,000	5,000,000					\$ 5,500,000
TOTAL TRANSPORTATION FUND - SAFE		\$ 7,194,000	5,602,000	132,000	3,060,000	2,369,000	1,005,000	\$19,362,000

TRANSPORTATION - STATE GAS TAX PROJECT SUMMARY

PAGE	PROJECT NAME	FY 2025	FY 2026	FY 2027	FY 2028	FY 2029	FY 2030	TOTAL
28	Ardenwald North Improvements	\$ 232,000						\$ 232,000
33	Downtown Curbs & Storm	55,000						55,000
37	Harvey Street Improvements	411,000	411,000					822,000
59	Salt & Rock Cover	75,000	50,000					125,000
65	Stanley SAFE Improvements	500,000						500,000
72	Washington Street Area Improvements	377,000						377,000
62	Signal and Intersection Upgrades	100,000	100,000	100,000	100,000	100,000	100,000	600,000
69	Transportation Capital Maintenance Program	500,000	500,000	500,000	500,000	500,000	500,000	3,000,000
43	Logus Road, 40th & 42nd Avenue		300,000		2,000,000			2,300,000
49	Monroe Street Greenway		1,261,000					1,261,000
57	Residential Street Surface Repair			500,000	500,000	500,000	500,000	2,000,000
68	Street Surface Slurry Seal				250,000	500,000	500,000	1,250,000
SUBTOTAL STATE GAS TAX		\$2,250,000	2,622,000	1,100,000	3,350,000	1,600,000	1,600,000	\$12,522,000

ODOT/K22576 GRANT

PAGE	PROJECT NAME	FY 2025	FY 2026	FY 2027	FY 2028	FY 2029	FY 2030	TOTAL
49	Monroe Street Greenway	\$	1,547,000					\$ 1,547,000
SUBTOTAL ODOT		\$	1,547,000					\$ 1,547,000

TOTAL TRANSPORTATION FUND - STATE GAS TAX		\$2,250,000	4,169,000	1,100,000	3,350,000	1,600,000	1,600,000	\$14,069,000
--	--	--------------------	------------------	------------------	------------------	------------------	------------------	---------------------

TRANSPORTATION SDC

PAGE	PROJECT NAME	FY 2025	FY 2026	FY 2027	FY 2028	FY 2029	FY 2030	TOTAL
33	Downtown Public Area Requirements	\$ 250,000						\$ 250,000
SUBTOTAL TRANSPORTATION SDC		\$ 250,000						\$ 250,000

ODOT GROWTH MANAGEMENT GRANT

PAGE	PROJECT NAME	FY 2025	FY 2026	FY 2027	FY 2028	FY 2029	FY 2030	TOTAL
70	Transportation System Plan	\$ 250,000						\$ 250,000
SUBTOTAL TRANSPORTATION SDC GRANT		\$ 250,000						\$ 250,000
TOTAL TRANSPORTATION SDC		\$ 500,000						\$ 500,000

WASTEWATER SDC

PAGE	PROJECT NAME	FY 2025	FY 2026	FY 2027	FY 2028	FY 2029	FY 2030	TOTAL
78	Waverly Heights Sewer System Reconfiguration	\$ 170,000	150,000					\$ 320,000
TOTAL WASTEWATER SDC		\$ 170,000	150,000					\$ 320,000

STORMWATER SDC

PAGE	PROJECT NAME	FY 2025	FY 2026	FY 2027	FY 2028	FY 2029	FY 2030	TOTAL
67	Stormwater System Plan	\$ 275,000	35,000					\$ 310,000
TOTAL STORMWATER SDC		\$ 275,000	35,000					\$ 310,000

TOTAL SYSTEM DEVELOPMENT CHARGES		\$ 945,000	185,000					\$ 1,130,000
---	--	-------------------	----------------	--	--	--	--	---------------------

WATER FUND PROJECT SUMMARY

PAGE	PROJECT NAME	FY 2025	FY 2026	FY 2027	FY 2028	FY 2029	FY 2030	TOTAL
25	40th and Harvey Concrete Reservoir	\$ 100,000	750,000					\$ 850,000
37	Harvey Street Improvements	1,600,000						1,600,000
41	King Road Improvements (43rd - Linwood)	602,000						602,000
42	Lava Drive Booster Pump Station	25,000	150,000					175,000
42	Lead Service Line Replacements	100,000	100,000	100,000				300,000
49	Monroe Street Greenway	250,000						250,000
71	VFD Improvements	50,000	50,000	50,000				150,000
72	Washington Street Area Improvements	100,000						100,000
74	Water Automation and Control Upgrades	60,000	60,000	50,000	50,000	50,000	50,000	320,000
74	Water Capital Maintenance Program	100,000	100,000	100,000	100,000	100,000	100,000	600,000
75	Water Pressure Zone Analysis	50,000						50,000
75	Water System Intertie Evaluation	75,000	50,000	350,000				475,000
77	Water Treatment Plant	300,000	300,000	450,000	3,500,000	3,500,000		8,050,000
79	Waverly South Improvements	162,000						162,000
81	Well 5 Improvements	50,000	600,000					650,000
84	Well 8	300,000						300,000
84	Well House HVAC Upgrades	25,000	25,000	50,000	50,000			150,000
43	Logus Road, 40th & 42nd Avenue		80,000		1,500,000			1,580,000
50	New Storage Reservoir		150,000	400,000	1,000,000		7,000,000	8,550,000
80	Well 4 Reconditioning		60,000					60,000
83	Well 6 & 7 Reconditioning Project		60,000	60,000				120,000
24	3rd Zone Pump Station Improvements			50,000		1,200,000		1,250,000
38	International Way Improvements			44,000	212,000			256,000
47	Miscellaneous Equipment Replacement and Upgrades			30,000	30,000			60,000
76	Water Transfer Pump Upgrades			150,000	1,500,000			1,650,000
82	Well 6 Pump Station Improvements			50,000				50,000
29	Ardenwald South Improvements				44,000	711,000		755,000
63	Sparrow Street Improvements				5,000	80,000		85,000
26	44th Avenue - Water System Improvements					240,000		240,000
27	Additional Water Rights Evaluation					25,000	25,000	50,000
35	Firwood Street - Water System Improvements					511,000		511,000
35	Flavel Drive - Water System Improvements					280,000		280,000
40	King Road Improvements (40th - 42nd)					133,000	722,000	855,000
45	McLoughlin - Water System Improvements					700,000		700,000
48	Monroe Street & Mullan Street Pipe Extension					409,000		409,000
58	Rio Vista Street - Water System Improvements						993,000	993,000
34	Elk Street Water System Improvements						252,000	252,000
52	Oatfield Road & Shell Lane Improvements						19,000	19,000
53	Park Street & Lloyd Street Improvements						350,000	350,000
77	Water Transmission Main Replacement						1,786,000	1,786,000
85	Winworth Court - Water System Improvements						125,000	125,000
SUBTOTAL WATER		\$ 3,949,000	2,535,000	1,934,000	7,991,000	7,939,000	11,422,000	\$ 35,770,000
AMERICAN RESCUE PLAN ACT (ARPA) - FEDERAL GRANT								
PAGE	PROJECT NAME	FY 2025	FY 2026	FY 2027	FY 2028	FY 2029	FY 2030	TOTAL
28	Ardenwald North Improvements	\$ 995,000						\$ 995,000
64	Stanley Reservoir Improvements	2,600,000						2,600,000
SUBTOTAL ARPA GRANT FUNDS - WATER		\$ 3,595,000						\$ 3,595,000
TOTAL WATER FUND		\$ 7,544,000	2,535,000	1,934,000	7,991,000	7,939,000	11,422,000	\$ 39,365,000

WASTEWATER FUND PROJECT SUMMARY

PAGE	PROJECT NAME	FY 2025	FY 2026	FY 2027	FY 2028	FY 2029	FY 2030	TOTAL
32	Brookside Pump Station Improvements	\$ 500,000						\$ 500,000
37	Harvey Street Improvements	87,000						87,000
56	Pump Station Condition Assessments	30,000						30,000
61	Sewer Lining Projects	1,059,000						1,059,000
72	Washington Street Area Improvements	100,000						100,000
73	Wastewater Capital Maintenance Program	50,000	50,000	50,000	50,000	50,000	50,000	300,000
78	Waverly Heights Sewer System Reconfiguration	945,000	945,000					1,890,000
79	Waverly South Improvements	202,000						202,000
38	International Way Improvements		18,000	294,000				312,000
43	Logus Road, 40th & 42nd Avenue		6,000		102,000			108,000
57	Pump Station Lift & SCADA Controls Replacement		50,000					50,000
39	Johnson Creek Siphon Inspection			110,000				110,000
44	Manhole Surveying			25,000	25,000		25,000	75,000
56	Pump Station Improvements			248,000	460,000			708,000
51	North Milwaukie Downtown Improvements					76,000	409,000	485,000
54	Pipeline Rehabilitation & Replacement					385,000	381,000	766,000
53	Park Street & Lloyd Street Improvements						77,000	77,000
SUBTOTAL WASTEWATER		\$ 2,973,000	1,069,000	727,000	637,000	511,000	942,000	\$ 6,859,000

AMERICAN RESCUE PLAN ACT (ARPA) - FEDERAL GRANT

PAGE	PROJECT NAME	FY 2025	FY 2026	FY 2027	FY 2028	FY 2029	FY 2030	TOTAL
28	Ardenwald North Improvements	\$ 745,000						\$ 745,000
SUBTOTAL ARPA GRANT FUNDS - WASTEWATER		\$ 745,000						\$ 745,000

WES INFLOW & INFILTRATION GRANT

PAGE	PROJECT NAME	FY 2025	FY 2026	FY 2027	FY 2028	FY 2029	FY 2030	TOTAL
61	Sewer Lining Projects	\$ 300,000						\$ 300,000
78	Waverly Heights Sewer System Reconfiguration	576,000	576,000					1,152,000
SUBTOTAL I&I GRANT FUNDS		\$ 876,000	\$ 576,000					\$ 1,452,000

TOTAL WASTEWATER FUND		\$ 4,594,000	1,645,000	727,000	637,000	511,000	942,000	\$ 9,056,000
------------------------------	--	---------------------	------------------	----------------	----------------	----------------	----------------	---------------------

STORMWATER FUND PROJECT SUMMARY

PAGE	PROJECT NAME	FY 2025	FY 2026	FY 2027	FY 2028	FY 2029	FY 2030	TOTAL
28	Ardenwald North Improvements	\$ 691,000						\$ 691,000
33	Downtown Curbs & Storm	500,000						500,000
36	Flood Mitigation Grant Match	50,000	50,000	50,000	50,000	50,000	50,000	300,000
37	Harvey Street Improvements	663,000						663,000
41	King Road Improvements (43rd - Linwood)	2,000,000						2,000,000
46	Meek Street Improvements	3,381,000						3,381,000
66	Stormwater Capital Maintenance Program	250,000	250,000	250,000	250,000	250,000	250,000	1,500,000
72	Washington Street Area Improvements	500,000						500,000
79	Waverly South Improvements	12,000						12,000
43	Logus Road, 40th & 42nd Avenue		35,000		637,000			672,000
49	Monroe Street Greenway		636,000					636,000
38	International Way Improvements			18,000	506,000			524,000
29	Ardenwald South Improvements				18,000	286,000		304,000
63	Sparrow Street Improvements				4,000	63,000		67,000
51	North Milwaukie Downtown Improvements					111,000	601,000	712,000
55	Plum, Apple, & Hemlock Streets					275,000	1,100,000	1,375,000
52	Oatfield Road & Shell Lane Improvements						49,000	49,000
53	Park Street & Lloyd Street Improvements						168,000	168,000
TOTAL STORMWATER FUND		\$8,047,000	971,000	318,000	1,465,000	1,035,000	2,218,000	\$14,054,000



26th Avenue Improvements

Lake Road to Dead End

SAFE/SSMP Improvements: Add sidewalk on 26th Avenue (Lake Road to dead end).

Operating Budget Impact: The project is anticipated to decrease operating expenditures through replacement of aging infrastructure.

Key Departments: Engineering, Public Works

	FY 2025	FY 2026	FY 2027	FY 2028	FY 2029	FY 2030	TOTAL
Capital Cost:							
Construction	\$ 162,000						\$ 162,000
TOTAL ESTIMATED CAPITAL COST	\$ 162,000						\$ 162,000
Funding Source:							
SSMP	\$ 88,000						\$ 88,000
SAFE	74,000						74,000
TOTAL FUNDING	\$ 162,000						\$ 162,000



3rd Zone Pump Station Improvements

Water Improvements: Replace the 3rd zone pump station with two (2) 2,000 GPM pumps at Stanley, per Water System Plan P2.

Operating Budget Impact: The project will not increase operating expenditures.

Key Departments: Public Works

	FY 2025	FY 2026	FY 2027	FY 2028	FY 2029	FY 2030	TOTAL
Capital Cost:							
Planning, Engineering, Design	\$		50,000				\$ 50,000
Construction					1,200,000		1,200,000
TOTAL ESTIMATED CAPITAL COST	\$		50,000		1,200,000		\$ 1,250,000
Funding Source:							
Water	\$		50,000		1,200,000		1,250,000
TOTAL FUNDING	\$		50,000		1,200,000		\$ 1,250,000



40th and Harvey Concrete Reservoir

Water Improvements: The concrete reservoir located at 40th and Harvey is a 1.5 million gallon storage tank originally constructed in 1923. This project includes seismic upgrades to add galvanized steel seismic cables at the wall base and foundation, add a circumferential steel strand prestressing and shotcrete to the outside face of the concrete wall, and add a fiber reinforced polymer jacketing to one or both faces of the concrete and a reinforced concrete curb around the perimeter of the base. The project also includes replacement of the interior liner.

Operating Budget Impact: None

Key Departments: Public Works

	FY 2025	FY 2026	FY 2027	FY 2028	FY 2029	FY 2030	TOTAL
Capital Cost:							
Planning, Engineering, Design	\$ 100,000						\$ 100,000
Construction		750,000					750,000
TOTAL ESTIMATED CAPITAL COST	\$ 100,000	750,000					\$ 850,000
Funding Source:							
Water	\$ 100,000	750,000					\$ 850,000
TOTAL FUNDING	\$ 100,000	750,000					\$ 850,000

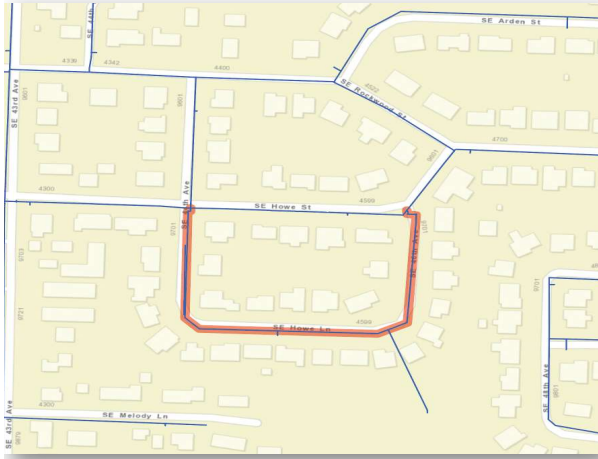

44th Avenue - Water System Improvements

44th Avenue, Howe Lane, 46th Avenue

Water Improvements: Replace 4-inch pipe with 260 feet of 8-inch water mainline pipe on 44th Avenue. Replace 4-inch water mainline pipe with 440 feet of 8-inch pipe on Howe Lane. Replace 4-inch water mainline pipe with 260 feet of 8-inch pipe on 46th Avenue.

Operating Budget Impact: Replacement of aging and undersized water distribution infrastructure will decrease maintenance costs related to emergency repairs of water main breaks.

Key Departments: Engineering, Public Works

	FY 2025	FY 2026	FY 2027	FY 2028	FY 2029	FY 2030	TOTAL
Capital Cost:							
Construction	\$				240,000		\$ 240,000
TOTAL ESTIMATED CAPITAL COST	\$				240,000		\$ 240,000
Funding Source:							
Water	\$				240,000		\$ 240,000
TOTAL FUNDING	\$				240,000		\$ 240,000



Additional Water Rights Evaluation

Water Improvements: Evaluate the need for additional water rights within the city limits.

Operating Budget Impact: The project will not increase operating expenditures.

Key Departments: Public Works

	FY 2025	FY 2026	FY 2027	FY 2028	FY 2029	FY 2030	TOTAL
Capital Cost:							
Planning, Engineering, Design	\$				25,000	25,000	\$ 50,000
TOTAL ESTIMATED CAPITAL COST	\$				25,000	25,000	\$ 50,000
Funding Source:							
Water	\$				25,000	25,000	\$ 50,000
TOTAL FUNDING	\$				25,000	25,000	\$ 50,000



Ardenwald North Improvements

28th Avenue, 29th Avenue, 30th Avenue, 31st Avenue, Roswell Street, Van Water Street

SAFE/SSMP Improvements: Repave Van Water Street (28th Avenue to 32nd Avenue), Roswell Street (28th Avenue to 32nd Avenue), Sherrett Street, 28th Avenue (Sherrett Street to Roswell Street), 28th Place (Van Water Street to Roswell), 30th Avenue (Sherrett Street to Van Water Street), and 31st Avenue (Sherrett Street to Van Water Street). Construct curb ramps at intersection of Roswell Street with 30th Avenue, 31st Avenue, and 32nd Avenue; intersection of Van Water Street with 32nd Avenue; and the West end of Roswell Street.

Water Improvements:

29th Avenue (Van Water Street to Roswell Street) replace 638 feet of 4-inch water mainline pipe with 8-inch pipe. 30th Avenue (Van Water Street to Roswell Street) replace 637 feet of 4-inch water mainline pipe with 8-inch pipe. 31st Avenue (Van Water Street to Roswell Street) replace 664 feet of 4-inch water mainline pipe with 8-inch pipe. Roswell Street (29th Avenue to 32nd Avenue) replace 720 feet of 4-inch water mainline pipe with 8-inch pipe.

Wastewater Improvements:

28th Avenue: Pipe burst 827 feet of sewer pipe from manhole 1213 to manhole 1211. 31st Avenue: Pipe burst 375 feet from manhole 1910 to manhole 1200. 29th Avenue: Replace 342 feet of sewer pipe from manhole 1222 to manhole 1220.

Stormwater Improvements:

Van Water Street (29th Avenue to 31st Avenue) replace 490 feet of stormwater pipe to improve maintenance.

Operating Budget Impact:

The project is anticipated to decrease operating expenditures through replacement of aging infrastructure.

Key Departments:

Engineering, Public Works

	FY 2025	FY 2026	FY 2027	FY 2028	FY 2029	FY 2030	TOTAL
Capital Cost:							
Construction	\$ 4,020,000						4,020,000
TOTAL ESTIMATED CAPITAL COST	\$ 4,020,000						\$ 4,020,000
Funding Source:							
SSMP	\$ 592,000						\$ 592,000
SAFE	765,000						765,000
Transportation	232,000						232,000
Water - ARPA Federal Funds	995,000						995,000
Wastewater - ARPA Federal Fund	745,000						745,000
Stormwater	691,000						691,000
TOTAL FUNDING	\$ 4,020,000						\$ 4,020,000



Ardenwald South Improvements

32nd Avenue, Balfour Street, Llewellyn Street, Malcom Street

SAFE/SSMP Improvements: 32nd Avenue (Roswell Street to Oak Street) replace portions of existing sidewalk and repave road. Balfour Street (32nd Avenue to Balfour Park) add sidewalk and repave road.

Water Improvements: 32nd Avenue (Kelvin Street to Filbert Street) replace 960 feet of 6-inch and 8-inch water mainline pipe. Llewellyn Street (32nd Avenue to 34th Avenue) replace 560 feet of 4-inch water mainline pipe. Malcolm Street (32nd Avenue to 29th Avenue) replace 710 feet of 4-inch water mainline pipe.

Stormwater Improvements: Add stormwater water quality facilities.

Operating Budget Impact: The project is anticipated to reduce operating expenditures by replacing aging infrastructure, but increase operating expenditures through construction of new stormwater quality facilities.

Key Departments: Engineering, Public Works

	FY 2025	FY 2026	FY 2027	FY 2028	FY 2029	FY 2030	TOTAL
Capital Cost:							
Planning, Engineering, Design	\$			262,000			\$ 262,000
Construction					4,264,000		4,264,000
TOTAL ESTIMATED CAPITAL COST	\$			262,000	4,264,000		\$ 4,526,000
Funding Source:							
SSMP	\$			68,000	1,107,000		\$ 1,175,000
SAFE				132,000	2,160,000		2,292,000
Water				44,000	711,000		755,000
Stormwater				18,000	286,000		304,000
TOTAL FUNDING	\$			262,000	4,264,000		\$ 4,526,000

Balfour Park

Master Plan & Implementation

Improvements: Improvements to Balfour Park were identified in a revised concept plan. A play area, water feature, picnic tables, benches, shelter, drinking fountain, irrigation, and electrical outlets will be installed in the park. Construction bids for Balfour Park are \$818,566 not including frontage improvements which are part of another project.

Operating Budget Impact: None

Key Departments: Public Works, Community Development, Planning

	FY 2025	FY 2026	FY 2027	FY 2028	FY 2029	FY 2030	TOTAL
Capital Cost:							
Construction		\$ 364,000					\$ 364,000
TOTAL ESTIMATED CAPITAL COST		\$ 364,000					\$ 364,000
Funding Source:							
General Fund Public Works Admin - ARPA Parks Federal Funds		\$ 204,000					\$ 204,000
General Fund Intergovernmental: Metro Parks Bond - Metro Nature in Neighborhoods Grant		87,000					87,000
General Fund Intergovernmental: Metro Parks Bond - Local Share Allocation		73,000					73,000
TOTAL FUNDING		\$ 364,000					\$ 364,000



Bowman-Brae Park

Master Plan & Implementation

Improvements: Improvements to Bowman-Brae Park were identified in a revised concept plan. A play area, picnic tables, benches, shelter, drinking fountain, irrigation, and electrical outlets will be installed in the park. Construction bids for Bowman-Brae Park are \$761,030.

Operating Budget Impact: None

Key Departments: Public Works, Community Development, Planning

	FY 2025	FY 2026	FY 2027	FY 2028	FY 2029	FY 2030	TOTAL
Capital Cost:							
Construction		\$ 365,000					\$ 365,000
TOTAL ESTIMATED CAPITAL COST		\$ 365,000					\$ 365,000
Funding Source:							
General Fund Public Works Admin		\$ 25,000					\$ 25,000
General Fund Public Works Admin - ARPA Parks Federal Funds		242,000					242,000
General Fund Intergovernmental: Metro Parks Bond - Metro Nature in Neighborhoods Grant		41,000					41,000
General Fund Intergovernmental: Metro Parks Bond - Local Share Allocation		32,000					32,000
SAFE		25,000					25,000
TOTAL FUNDING		\$ 365,000					\$ 365,000



Bowman Brae & Where Else Lane

SAFE Improvements: Installation of a multi use path to connect the park.

Operating Budget Impact: None

Key Departments: Engineering, Public Works

	FY 2025	FY 2026	FY 2027	FY 2028	FY 2029	FY 2030	TOTAL
Capital Cost:							
Construction	\$	25,000					\$ 25,000
TOTAL ESTIMATED CAPITAL COST	\$	25,000					\$ 25,000
Funding Source:							
SAFE	\$	25,000					\$ 25,000
TOTAL FUNDING	\$	25,000					\$ 25,000



Brookside Pump Station Improvements

Wastewater Improvements: Replace wastewater pumps.

Operating Budget Impact: None

Key Departments: Engineering, Public Works

	FY 2025	FY 2026	FY 2027	FY 2028	FY 2029	FY 2030	TOTAL
Capital Cost:							
Construction	\$	500,000					\$ 500,000
TOTAL ESTIMATED CAPITAL COST	\$	500,000					\$ 500,000
Funding Source:							
Wastewater	\$	500,000					\$ 500,000
TOTAL FUNDING	\$	500,000					\$ 500,000



Downtown Curbs & Storm

Main Street between Monroe and Jefferson Street

Transportation Improvements: Sidewalk improvements along the west side of Main Street between Monroe and Jefferson Streets.

Stormwater Improvements: Extending storm lines from McLoughlin Blvd. to the intersections of Main/Monroe and Main/Jefferson.

Operating Budget Impact: Unknown

Key Departments: Engineering, Public Works

	FY 2025	FY 2026	FY 2027	FY 2028	FY 2029	FY 2030	TOTAL
Capital Cost:							
Construction	\$ 555,000						\$ 555,000
TOTAL ESTIMATED CAPITAL COST	\$ 555,000						\$ 555,000
Funding Source:							
Transportation	\$ 55,000						\$ 55,000
Stormwater	500,000						500,000
TOTAL FUNDING	\$ 555,000						\$ 555,000



Downtown Public Area Requirements

SDC Improvements: Installation of sidewalks on the Coho development project on Washington and Main Street.

Operating Budget Impact: Unknown

Key Departments: Engineering, Public Works

	FY 2025	FY 2026	FY 2027	FY 2028	FY 2029	FY 2030	TOTAL
Capital Cost:							
Construction	\$ 250,000						\$ 250,000
TOTAL ESTIMATED CAPITAL COST	\$ 250,000						\$ 250,000
Funding Source:							
Transportation SDC	\$ 250,000						\$ 250,000
TOTAL FUNDING	\$ 250,000						\$ 250,000



Elk Street Water System Improvements

Elk Street, 51st Avenue, 52nd Avenue

Water Improvements: Replace 4-inch water mainline pipe with 240 feet of 8-inch pipe on Elk Street. Install 380 feet of 8-inch water mainline pipe on 51st Avenue. Install 380 feet of 8-inch water mainline pipe on 52nd Avenue.

Operating Budget Impact: Replacement of undersized water distribution infrastructure will decrease maintenance costs related to emergency repairs of water main breaks.

Key Departments: Engineering, Public Works

	FY 2025	FY 2026	FY 2027	FY 2028	FY 2029	FY 2030	TOTAL
Capital Cost:							
Construction	\$					252,000	\$ 252,000
TOTAL ESTIMATED CAPITAL COST	\$					252,000	\$ 252,000
Funding Source:							
Water	\$					252,000	\$ 252,000
TOTAL FUNDING	\$					252,000	\$ 252,000

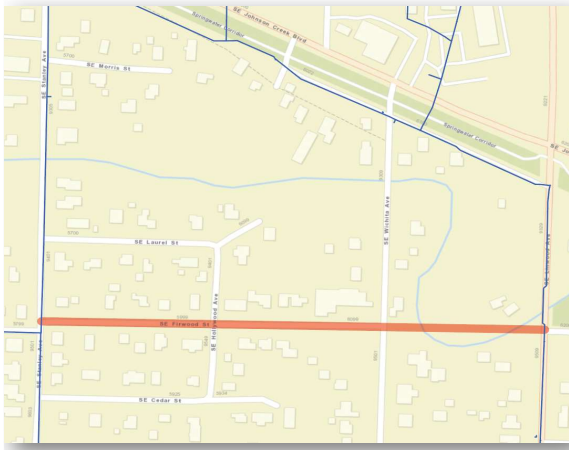

Firwood Street - Water System Improvements

Water Improvements: Install 1470 feet of 12-inch water mainline pipe on Firwood Street.

Operating Budget Impact: Replacement of aging and undersized water distribution infrastructure will decrease maintenance costs related to emergency repairs of water main breaks.

Key Departments: Engineering, Public Works

	FY 2025	FY 2026	FY 2027	FY 2028	FY 2029	FY 2030	TOTAL
Capital Cost:							
Construction	\$				511,000		\$ 511,000
TOTAL ESTIMATED CAPITAL COST	\$				511,000		\$ 511,000
Funding Source:							
Water	\$				511,000		\$ 511,000
TOTAL FUNDING	\$				511,000		\$ 511,000

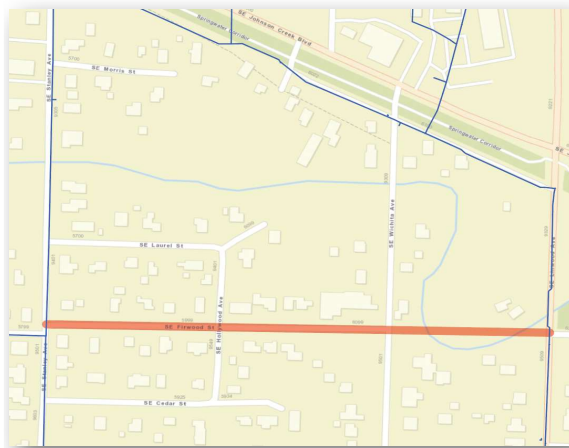

Flavel Drive - Water System Improvements

Water Improvements: Install 800 feet of 12-inch water mainline pipe on Flavel Drive.

Operating Budget Impact: Replacement of aging and undersized water distribution infrastructure will decrease maintenance costs related to emergency repairs of water main breaks.

Key Departments: Engineering, Public Works

	FY 2025	FY 2026	FY 2027	FY 2028	FY 2029	FY 2030	TOTAL
Capital Cost:							
Construction	\$				280,000		\$ 280,000
TOTAL ESTIMATED CAPITAL COST	\$				280,000		\$ 280,000
Funding Source:							
Water	\$				280,000		\$ 280,000
TOTAL FUNDING	\$				280,000		\$ 280,000



Flood Mitigation Grant Match

Stormwater Improvements: Federal Emergency Management Agency (FEMA) Flood Mitigation Assistance Grant funding can be used for projects that reduce or eliminate the risk of repetitive flood damage to buildings insured by the National Flood Insurance Program. This project will fund the required 10% non-federal grant match required to apply and obtain FEMA funding.

Operating Budget Impact: Unknown

Key Departments: Engineering, Public Works

	FY 2025	FY 2026	FY 2027	FY 2028	FY 2029	FY 2030	TOTAL
Capital Cost:							
Land / ROW Acquisition	\$ 50,000	50,000	50,000	50,000	50,000	50,000	\$ 300,000
TOTAL ESTIMATED CAPITAL COST	\$ 50,000	50,000	50,000	50,000	50,000	50,000	\$ 300,000
Funding Source:							
Stormwater	\$ 50,000	50,000	50,000	50,000	50,000	50,000	\$ 300,000
TOTAL FUNDING	\$ 50,000	50,000	50,000	50,000	50,000	50,000	\$ 300,000



Harvey Street Improvements

Harvey Street, 33rd Avenue, 36th Avenue and 42nd Avenue

SAFE/SSMP Improvements: On Harvey Street (32nd Ave to 42nd Ave) and 42nd Ave (Howe St to Harvey St), replace or construct continuous ADA-compliant sidewalk on one side and install traffic calming measures to improve the neighborhood greenway along Harvey Street from 32nd Ave to 42nd Ave. Update signs and markings, install a set of Rectangular Rapid Flashing Beacons (RRFB) at the southern crossing at the intersection of Roswell Street and 42nd Ave. Grind and pave Harvey Street (32nd Ave to east end), 33rd Ave. (north of Harvey St), 36th Ave (north of Harvey St), Sherry Street (West of 36th Ave), Wake Court (West of 42nd Ave), and 42nd Ave (Harvey Street to Johnson Creek Blvd).

Water Improvements: Harvey Street (32nd Ave to 36th Ave and 40th Ave to 42nd Ave) transfer all services to the existing 12" main. Harvey Street (36th Ave to 40th Ave) install an 8-inch water mainline pipe and transfer all services to it. 33rd Ave (Harvey Street to dead end) replace 470 feet of 4-inch water mainline pipe with 8-inch pipe. 36th Ave (Harvey St. to dead end) install an 8-inch water mainline pipe and transfer all services to it. 42nd Ave (Harvey St. to Howe St.) transfer all services to the existing 12" main. Abandon all replaced 4" and 6" mains, replace all fire hydrants older than 1990, install new hydrants to reach 400 ft. spacing requirement, and install two water sampling stations.

Wastewater Improvements: Replace mainline from Harvey Street and Drake Street.

Stormwater Improvements: Address the fail drywell reported at the intersection of 42nd Ave and Howe St. and another drywell just east of the intersection of 42nd Ave and Harvey St. Treatment facilities will be installed as well as the replacement of storm sewer laterals as necessary.

Operating Budget Impact: The project is anticipated to decrease operating expenditures through replacement of aging infrastructure.

Key Departments: Engineering, Public Works

	FY 2025	FY 2026	FY 2027	FY 2028	FY 2029	FY 2030	TOTAL
Capital Cost:							
Construction	\$ 3,685,000	1,335,000					\$ 5,020,000
TOTAL ESTIMATED CAPITAL COST	\$ 3,685,000	1,335,000					\$ 5,020,000
Funding Source:							
SSMP	\$ 479,000	479,000					\$ 958,000
SAFE	445,000	445,000					890,000
Transportation	411,000	411,000					822,000
Water	1,600,000						1,600,000
Wastewater	87,000						87,000
Stormwater	663,000						663,000
TOTAL FUNDING	\$ 3,685,000	1,335,000					\$ 5,020,000

International Way Improvements

International Way (37th Avenue to Lake Road) and Mallard Way (International Way to Mallard Way bridge)



- SAFE/SSMP Improvements:** International Way (37th Avenue to Lake Road) add sidewalk, bicycle lanes, and repave road. Mallard Street (International Way to the Mallard Street Bridge) add sidewalk.
- Water Improvements:** International Way (Freeman Way to Mallard Way) install of 820 feet of 12-inch water mainline pipe to connect gap in existing water mainline pipe.
- Wastewater Improvements:** Replace 354 feet of 12-inch sewer pipe from manhole 3033 to manhole 3032.
- Stormwater Improvements:** Upsize existing 20-inch private culverts under International Way to mitigate flooding.
- Operating Budget Impact:** The project is anticipated to decrease operating expenditures through replacement of aging infrastructure and mitigation of flooding.
- Key Departments:** Engineering, Public Works

	FY 2025	FY 2026	FY 2027	FY 2028	FY 2029	FY 2030	TOTAL
Capital Cost:							
Planning, Engineering, Design	\$		280,000				\$ 280,000
Construction				3,282,000			3,282,000
TOTAL ESTIMATED CAPITAL COST	\$		280,000	3,282,000			\$ 3,562,000
Funding Source:							
SSMP	\$		68,000	446,000			\$ 514,000
SAFE			132,000	1,824,000			1,956,000
Water			44,000	212,000			256,000
Wastewater			18,000	294,000			312,000
Stormwater			18,000	506,000			524,000
TOTAL FUNDING	\$		280,000	3,282,000			\$ 3,562,000



Johnson Creek Siphon Inspection

Wastewater Improvements: This project is identified to conduct an evaluation of the alternatives and options considering the siphon that crosses Johnson Creek .

Operating Budget Impact: None

Key Departments: Public Works

	FY 2025	FY 2026	FY 2027	FY 2028	FY 2029	FY 2030	TOTAL
Capital Cost:							
Construction	\$		110,000				\$ 110,000
TOTAL ESTIMATED CAPITAL COST	\$		110,000				\$ 110,000
Funding Source:							
Wastewater	\$		110,000				\$ 110,000
TOTAL FUNDING	\$		110,000				\$ 110,000



King Road Improvements (40th - 42nd)

40th Avenue to 42nd Avenue

SAFE/SSMP Improvements: King Road (40th Avenue to 42nd Avenue) replace existing sidewalk with multiuse path and repave road.

Water Improvements: King Road (36th Avenue to 42nd Avenue) replace 1,660 feet of 6-inch and 8-inch water mainline pipe with 12-inch pipe.

Operating Budget Impact: The project is anticipated to reduce operating expenditures by replacing aging infrastructure.

Key Departments: Engineering, Public Works

	FY 2025	FY 2026	FY 2027	FY 2028	FY 2029	FY 2030	TOTAL
Capital Cost:							
Planning, Engineering, Design	\$				219,000		\$ 219,000
Construction						1,188,000	1,188,000
TOTAL ESTIMATED CAPITAL COST	\$				219,000	1,188,000	\$ 1,407,000
Funding Source:							
SSMP	\$				21,000	113,000	\$ 134,000
SAFE					65,000	353,000	418,000
Water					133,000	722,000	855,000
TOTAL FUNDING	\$				219,000	1,188,000	\$ 1,407,000



King Road Improvements (43rd - Linwood)

43rd Avenue to Linwood Avenue

SAFE/SSMP Improvements: King Road (43rd Avenue to Linwood Avenue) replace existing sidewalk with multiuse path and repave road.

Water Improvements: Abandoning a 4-inch pipeline and moving services over. Replacing fire hydrants older than 1990 and adjusting meter boxes.

Stormwater Improvements: Review existing system for areas of improvement.

Operating Budget Impact: The project is anticipated to reduce operating expenditures by replacing aging infrastructure.

Key Departments: Engineering, Public Works

	FY 2025	FY 2026	FY 2027	FY 2028	FY 2029	FY 2030	TOTAL
Capital Cost:							
Construction	\$ 6,628,000	1,571,000					\$ 8,199,000
TOTAL ESTIMATED CAPITAL COST	\$ 6,628,000	1,571,000					\$ 8,199,000
Funding Source:							
SSMP	\$	1,571,000					\$ 1,571,000
SAFE	4,026,000						4,026,000
Water	602,000						602,000
Stormwater	2,000,000						2,000,000
TOTAL FUNDING	\$ 6,628,000	1,571,000					\$ 8,199,000



Lava Drive Booster Pump Station

Backup Generator

Water Improvements: This project provides for a new onsite backup generator for the Lava Pump Station. Currently emergency power is provided by a portable trailer mounted generator which must be moved to the site when needed.

Operating Budget Impact: None

Key Departments: Public Works

	FY 2025	FY 2026	FY 2027	FY 2028	FY 2029	FY 2030	TOTAL
Capital Cost:							
Construction	\$ 25,000	150,000					\$ 175,000
TOTAL ESTIMATED CAPITAL COST	\$ 25,000	150,000					\$ 175,000
Funding Source:							
Water	\$ 25,000	150,000					\$ 175,000
TOTAL FUNDING	\$ 25,000	150,000					\$ 175,000



Lead Service Line Replacements

Water Improvements: In the event that Public Works or Engineering discover lead service lines during a project then will replace the service line.

Operating Budget Impact: The project will not increase operating expenditures.

Key Departments: Public Works

	FY 2025	FY 2026	FY 2027	FY 2028	FY 2029	FY 2030	TOTAL
Capital Cost:							
Construction	\$ 100,000	100,000	100,000				\$ 300,000
TOTAL ESTIMATED CAPITAL COST	\$ 100,000	100,000	100,000				\$ 300,000
Funding Source:							
Water	\$ 100,000	100,000	100,000				\$ 300,000
TOTAL FUNDING	\$ 100,000	100,000	100,000				\$ 300,000



Logus Road, 40th & 42nd Avenue

Improvements to 40th Avenue, Logus Road, 42nd Avenue, 38th Avenue, Drake Street, 38th Avenue & 45th Court

Transportation Improvements: Improve intersection functionality at Harrison and 42nd (roundabout, signal or similar means).

SAFE/SSMP Improvements: Logus Road (43rd Avenue to 49th Avenue) add sidewalk and pave road. 40th Avenue (Harvey Street to King Road) and 42nd Avenue (Monroe Street to King Road) replace curb ramps and repave road. Improve intersection functionality at Harrison and 42nd (roundabout, signal or similar means).

Water Improvements: Drake Street and 38th Avenue: Replace 800 feet of 4-inch water main line pipe with 8-inch to improve fire flows.

Wastewater Improvements: 38th Avenue: Replace 254 feet of 8-inch sewer pipe from manhole 2120 to manhole 2118 to address significant belly in the mainline requires frequent maintenance. 45th Court: Replace 150 feet of 6-inch sewer pipe from manhole 3503 to manhole 3316 to eliminate backup that requires frequent maintenance.

Stormwater Improvements: Add stormwater quality facilities along Logus Road, 40th Avenue, and 42nd Avenue.

Operating Budget Impact: The project is anticipated to decrease operating expenditures through replacement of aging infrastructure and increase operating expenditures by adding stormwater quality facilities.

Key Departments: Engineering, Public Works

	FY 2025	FY 2026	FY 2027	FY 2028	FY 2029	FY 2030	TOTAL
Capital Cost:							
Planning, Engineering, Design	\$	630,000					\$ 630,000
Construction				8,139,000			8,139,000
TOTAL ESTIMATED CAPITAL COST	\$	630,000		8,139,000			\$ 8,769,000
Funding Source:							
SSMP	\$	152,000		2,800,000			\$ 2,952,000
SAFE		57,000		1,100,000			1,157,000
Transportation		300,000		2,000,000			2,300,000
Water		80,000		1,500,000			1,580,000
Wastewater		6,000		102,000			108,000
Stormwater		35,000		637,000			672,000
TOTAL FUNDING	\$	630,000		8,139,000			\$ 8,769,000



Manhole Surveying

Wastewater Improvements: This project will gather invert elevation of pipes entering and leaving manholes around the city to provide better information for future construction projects and system modeling.

Operating Budget Impact: None

Key Departments: Public Works

	FY 2025	FY 2026	FY 2027	FY 2028	FY 2029	FY 2030	TOTAL
Capital Cost:							
Construction	\$		25,000	25,000		25,000	\$ 75,000
TOTAL ESTIMATED CAPITAL COST	\$		25,000	25,000		25,000	\$ 75,000
Funding Source:							
Wastewater	\$		25,000	25,000		25,000	\$ 75,000
TOTAL FUNDING	\$		25,000	25,000		25,000	\$ 75,000

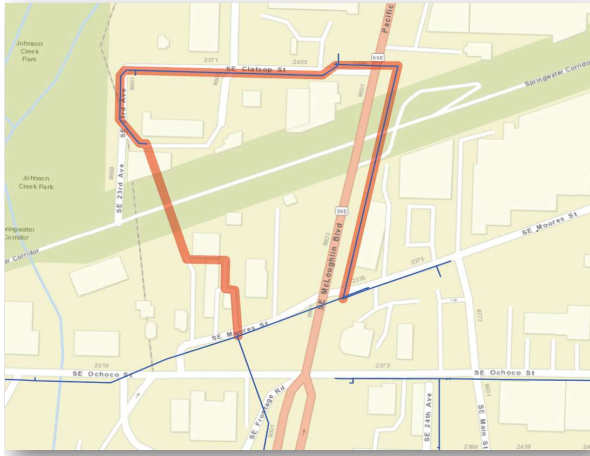

McLoughlin - Water System Improvements

23rd Avenue, Clatsop Street, McLoughlin Boulevard

Water Improvements: Install 750 feet of 12-inch water mainline pipe on 23rd Avenue. Replace 6-inch water mainline pipe with 600 feet of 12-inch pipe on Clatsop Street. Replace 6-inch water mainline pipe with 660 feet of 12-inch pipe on McLoughlin Boulevard.

Operating Budget Impact: Replacement of aging and undersized water distribution infrastructure will decrease maintenance costs related to emergency repairs of water main breaks.

Key Departments: Engineering, Public Works

	FY 2025	FY 2026	FY 2027	FY 2028	FY 2029	FY 2030	TOTAL
Capital Cost:							
Construction	\$				700,000		\$ 700,000
TOTAL ESTIMATED CAPITAL COST	\$				700,000		\$ 700,000
Funding Source:							
Water	\$				700,000		\$ 700,000
TOTAL FUNDING	\$				700,000		\$ 700,000



Meek Street Improvements (North Phase)

Boyd Street to Meek Street

Stormwater Improvements: Install stormwater mainline pipe from existing pipeline at Meek Street and route stormwater north to discharge at the existing Roswell Pond Open Space and ultimately into Johnson Creek. Project will alleviate flooding in the Harrison Street stormwater system.

Operating Budget Impact: This project will increase operating expenditures due to the added expense of maintaining the additional pipe and detention ponds. However, this project will also reduce the amount of emergency maintenance on Harrison Street due to flooding caused by its undersized system.

Key Departments: Engineering, Public Works

	FY 2025	FY 2026	FY 2027	FY 2028	FY 2029	FY 2030	TOTAL
Capital Cost:							
Construction	\$ 3,381,000						\$ 3,381,000
TOTAL ESTIMATED CAPITAL COST	\$ 3,381,000						\$ 3,381,000
Funding Source:							
Stormwater	\$ 3,381,000						\$ 3,381,000
TOTAL FUNDING	\$ 3,381,000						\$ 3,381,000



Miscellaneous Equipment Replacement and Upgrades

Water Improvements: For unspecified, miscellaneous equipment replacement and upgrades as needed, per Water System Plan SS1.

Operating Budget Impact: The project will not increase operating expenditures.

Key Departments: Public Works

	FY 2025	FY 2026	FY 2027	FY 2028	FY 2029	FY 2030	TOTAL
Capital Cost:							
Construction	\$		30,000	30,000			\$ 60,000
TOTAL ESTIMATED CAPITAL COST	\$		30,000	30,000			\$ 60,000
Funding Source:							
Water	\$		30,000	30,000			\$ 60,000
TOTAL FUNDING	\$		30,000	30,000			\$ 60,000

Monroe Street & Mullan Street Pipe Extension



Water Improvements:

Monroe Street Pipe Extension: Extend 8-inch waterline pipe main east from Linwood Avenue, down Monroe Street, then south on 66th Avenue to connect to the existing 6-inch water mainline. This project will provide redundancy in the system and improve fire flows in this area. Mullan Street Pipe Extension: Install water mainline pipe in Mullan Street to connect to the existing 6-inch water mainline pipe on 51st Avenue and near the intersection of Mullan Street and 54th Court. This project will address hydraulic, structural, and water quality issues as well as loop the system.

Operating Budget Impact:

This project is anticipated to reduce operating expenditures due to the anticipated reduction of water quality flushing.

Key Departments:

Engineering, Public Works

	FY 2025	FY 2026	FY 2027	FY 2028	FY 2029	FY 2030	TOTAL
Capital Cost:							
Construction	\$				409,000		\$ 409,000
TOTAL ESTIMATED CAPITAL COST	\$				409,000		\$ 409,000
Funding Source:							
Water	\$				409,000		\$ 409,000
TOTAL FUNDING	\$				409,000		\$ 409,000

Monroe Street Greenway



Transportation Improvements: The Monroe Greenway will create a nearly four-mile, continuous, low-stress bikeway from downtown Milwaukie to the I-205 multi-use path. Once complete, it will serve as the spine of Milwaukie’s active transportation network connecting users to the Max Orange Line, Max Green Line, Trolley Trail, 17th Avenue Bike Path, I-205 path, neighborhoods, schools, and parks.

The eastern segment runs from the cycle track at the intersection of 37th Avenue and Washington Street and runs along Washington Street before pivoting onto Monroe Avenue all the way to the eastern city limit at Linwood Avenue. This segment will include one ADA-compliant sidewalk along Monroe Street, ADA-compliant sidewalk on both sides of Washington Street, and incorporate traffic calming measures to make this an effective greenway.

The western segment will run from the intersection of Oak Street and Monroe Street, across the railroad tracks to Campbell Street, along Campbell Street to Monroe Street, and along Monroe Street across Highway 224 and the Max Orange Line to downtown Milwaukie.

- SAFE/SSMP Improvements:** Replace portions of existing sidewalk, remove barriers, and construct new surface overlay from 25th Avenue to 28th Avenue.
- Water Improvements:** Approximately 210 feet of water main will be enlarged crossing Highway-224.
- Stormwater Improvements:** Stormwater treatment facilities will be installed as required and flooding issues at the intersection of 55th Avenue and Monroe Street will be corrected.
- Operating Budget Impact:** Potential increase to ongoing operational needs due to the addition of new infrastructure. However, the pipe replacements would decrease ongoing operational needs by restoring infrastructure to good condition.
- Key Departments:** Community Development, Engineering, Public Works

	FY 2025	FY 2026	FY 2027	FY 2028	FY 2029	FY 2030	TOTAL
Capital Cost:							
Planning, Engineering, Design	\$ 582,000						\$ 582,000
Land / ROW Acquisition		671,000					671,000
Construction / Utility Relocates		6,921,000					6,921,000
TOTAL ESTIMATED CAPITAL COST	\$ 582,000	7,592,000					\$ 8,174,000
Central Funding Source:							
Water	\$ 250,000						\$ 250,000
ODOT/K22576		1,547,000					1,547,000
Urban Renewal Authority	332,000	1,000,000					1,332,000
East Funding Source:							
Transportation	\$	1,261,000					\$ 1,261,000
Stormwater		636,000					636,000
TOTAL CITY FUNDING	\$ 582,000	4,444,000					\$ 5,026,000
Other East Funding Source:							
ODOT/RRFA/Other/K22141	\$	3,148,000					\$ 3,148,000
TOTAL OTHER FUNDING	\$	3,148,000					\$ 3,148,000
TOTAL FUNDING	\$ 582,000	7,592,000					\$ 8,174,000



New Storage Reservoir

Water Improvements: Identify location and possible land acquisition. Determine pressure zone and size of reservoir. Design and construct a new storage reservoir.

Operating Budget Impact: The project will not increase operating expenditures.

Key Departments: Engineering, Public Works

	FY 2025	FY 2026	FY 2027	FY 2028	FY 2029	FY 2030	TOTAL
Capital Cost:							
Planning, Engineering, Design	\$	150,000	400,000				\$ 550,000
Land / ROW Acquisition				1,000,000			1,000,000
Construction						7,000,000	7,000,000
TOTAL ESTIMATED CAPITAL COST	\$	150,000	400,000	1,000,000		7,000,000	\$ 8,550,000
Funding Source:							
Water	\$	150,000	400,000	1,000,000		7,000,000	\$ 8,550,000
TOTAL FUNDING	\$	150,000	400,000	1,000,000		7,000,000	\$ 8,550,000



North Milwaukie Downtown Improvements

Harrison Street to Milwaukie Expressway

SAFE/SSMP Improvements: Main Street (Harrison Street to Milwaukie Expressway) construct downtown sidewalk improvements, improve bike connectivity, and repave road.

Wastewater Improvements: Main Street: Replace 445 feet of 8-inch sewer pipe from manhole 1157 to manhole 1156 to address multiple holes and fractures in the mainline, as well as significant buildup of fats, oils, and grease.

Stormwater Improvements: Add stormwater quality facilities.

Operating Budget Impact: The project is anticipated to reduce operating expenditures by replacing aging infrastructure, but increase operating expenditures through construction of new stormwater quality facilities.

Key Departments: Engineering, Public Works

	FY 2025	FY 2026	FY 2027	FY 2028	FY 2029	FY 2030	TOTAL
Capital Cost:							
Planning, Engineering, Design	\$				387,000		\$ 387,000
Construction						2,099,000	2,099,000
TOTAL ESTIMATED CAPITAL COST	\$				387,000	2,099,000	\$ 2,486,000
Funding Source:							
SSMP	\$				110,000	598,000	\$ 708,000
SAFE					90,000	491,000	581,000
Wastewater					76,000	409,000	485,000
Stormwater					111,000	601,000	712,000
TOTAL FUNDING	\$				387,000	2,099,000	\$ 2,486,000

Oatfield Road & Shell Lane Improvements

Oatfield Road, Lake Road to Kellogg Creek Bridge, and Shell Lane, Lake Road to Licyntra Lane



- SAFE/SSMP Improvements:** Oatfield Road (Lake Road to City Limits) construct sidewalk on both sides of street, add bike infrastructure, and repave road. Shell Lane (Lake Road to Licyntra Lane) repave road.
- Water Improvements:** Shell Lane: install 420 feet of 6-inch water mainline pipe to connect the existing pipes on Shell Lane and Licyntra Lane to address hydraulic, structural, and water quality issues.
- Stormwater Improvements:** Add stormwater quality facilities.
- Operating Budget Impact:** The project is anticipated to decrease operating expenditures related to maintenance of existing water mains and increase operating expenditures through construction of new stormwater quality facilities.
- Key Departments:** Engineering, Public Works

	FY 2025	FY 2026	FY 2027	FY 2028	FY 2029	FY 2030	TOTAL
Capital Cost:							
Planning, Engineering, Design	\$					128,000	\$ 128,000
TOTAL ESTIMATED CAPITAL COST	\$					128,000	\$ 128,000
Funding Source:							
SSMP	\$					37,000	\$ 37,000
SAFE						23,000	23,000
Water						19,000	19,000
Stormwater						49,000	49,000
TOTAL FUNDING	\$					\$ 128,000	\$ 128,000

Park Street & Lloyd Street Improvements

Park Street, Lloyd Street, Beckman Avenue, Stanley Avenue



- SAFE/SSMP Improvements:** Park Street (Home Avenue to Beckman Avenue), Beckman Terrace (Beckman Avenue to 56th Avenue), 56th Avenue (Beckman Terrace to Lloyd Street) and Lloyd Street (56th Avenue to Stanley Avenue) to add sidewalk or remove barriers in existing sidewalk and repave road. Beckman Avenue (Park Street to Beckman Terrace) to add sidewalk. Stanley Avenue (Railroad Avenue to Lloyd Street) to repave road.
- Water Improvements:** Beckman Avenue: Upsize from 6-inch water main to 8-inch. Park Street: Upsize from 6-inch to 8-inch.
- Wastewater Improvements:** Beckman Avenue: Replace 401 feet of 8-inch sewer pipe from manhole 3212 to manhole 3211 to address multiple bellies that can cause backup and property damage.
- Stormwater Improvements:** Add stormwater quality facilities.
- Operating Budget Impact:** The project is anticipated to decrease operating expenditures through replacement of aging infrastructure.
- Key Departments:** Engineering, Public Works

	FY 2025	FY 2026	FY 2027	FY 2028	FY 2029	FY 2030	TOTAL
Capital Cost:							
Planning, Engineering, Design	\$					919,000	\$ 919,000
TOTAL ESTIMATED CAPITAL COST	\$					919,000	\$ 919,000
Funding Source:							
SSMP	\$					186,000	\$ 186,000
SAFE						138,000	138,000
Water						350,000	350,000
Wastewater						77,000	77,000
Stormwater						168,000	168,000
TOTAL FUNDING	\$					919,000	\$ 919,000



Pipeline Rehabilitation & Replacement

Wastewater Improvements: Pipeline rehabilitation and replacement, per the Wastewater System plan C-1.

Operating Budget Impact: The project will not increase operating expenditures.

Key Departments: Public Works

	FY 2025	FY 2026	FY 2027	FY 2028	FY 2029	FY 2030	TOTAL
Capital Cost:							
Construction	\$				385,000	381,000	\$ 766,000
TOTAL ESTIMATED CAPITAL COST	\$				385,000	381,000	\$ 766,000
Funding Source:							
Wastewater	\$				385,000	381,000	\$ 766,000
TOTAL FUNDING	\$				385,000	381,000	\$ 766,000

Plum, Apple, & Hemlock Streets



Stormwater Improvements:

Plum Street and Apple Street: Install 780 feet of 12-inch stormwater pipe from the intersection of Plum and Apple Streets to the intersection of Juniper and Aspen Streets. This project will provide increased capacity to alleviate local flooding problems. Hemlock Street: Replace existing stormwater pipe on Hemlock Street and Cedarcrest Drive. The existing pipe is undersized and currently floods in heavy rain events.

Operating Budget Impact:

The project installs new pipe and replaces existing undersized pipe. There will be a net reduction in operating expenditures because stormwater crews are routinely called to this area to help alleviate flooding.

Key Departments:

Engineering, Public Works

	FY 2025	FY 2026	FY 2027	FY 2028	FY 2029	FY 2030	TOTAL
Capital Cost:							
Planning, Engineering, Design	\$				275,000		\$ 275,000
Construction						1,100,000	1,100,000
TOTAL ESTIMATED CAPITAL COST	\$				275,000	1,100,000	\$ 1,375,000
Funding Source:							
Stormwater	\$				275,000	1,100,000	\$ 1,375,000
TOTAL FUNDING	\$				275,000	1,100,000	\$ 1,375,000



Pump Station Condition Assessments

Wastewater Improvements: A detailed condition assessment of each of the five pump stations is recommended to determine potential repairs that may be required and to develop a schedule for anticipated refurbishments.

Operating Budget Impact: None

Key Departments: Public Works

	FY 2025	FY 2026	FY 2027	FY 2028	FY 2029	FY 2030	TOTAL
Capital Cost:							
Construction	\$	30,000					\$ 30,000
TOTAL ESTIMATED CAPITAL COST	\$	30,000					\$ 30,000
Funding Source:							
Wastewater	\$	30,000					\$ 30,000
TOTAL FUNDING	\$	30,000					\$ 30,000



Pump Station Improvements

Wastewater Improvements: These planned pump station upgrade projects consist of electrical and pumping upgrades for any equipment that has become obsolete and for which replacement parts are no longer available, or where reliability, efficiency, or accuracy has degraded below acceptable levels. Mechanical pumping equipment may consist of replacing pumps and motors to address changes in pump station capacity needs, or where reliability and efficiency have degraded below acceptable levels.

Operating Budget Impact: Completing preventative maintenance should reduce operating and emergency expenditures.

Key Departments: Public Works

	FY 2025	FY 2026	FY 2027	FY 2028	FY 2029	FY 2030	TOTAL
Capital Cost:							
Planning, Engineering, Design	\$		248,000				\$ 248,000
Construction				460,000			460,000
TOTAL ESTIMATED CAPITAL COST	\$		248,000	460,000			\$ 708,000
Funding Source:							
Wastewater	\$		248,000	460,000			\$ 708,000
TOTAL FUNDING	\$		248,000	460,000			\$ 708,000



Pump Station Lift & SCADA Controls Replacement

Wastewater Improvements: A program that replaces the city's lift station pumps and SCADA controls prior to failures and/or service interruptions.

Operating Budget Impact: Completing preventative maintenance in advance of emergency repairs should reduce the possibility of sewer back up, claims against the city, and reduce operating expenditures.

Key Departments: Public Works

	FY 2025	FY 2026	FY 2027	FY 2028	FY 2029	FY 2030	TOTAL
Capital Cost:							
Construction	\$	50,000					\$ 50,000
TOTAL ESTIMATED CAPITAL COST	\$	50,000					\$ 50,000
Funding Source:							
Wastewater	\$	50,000					\$ 50,000
TOTAL FUNDING	\$	50,000					\$ 50,000

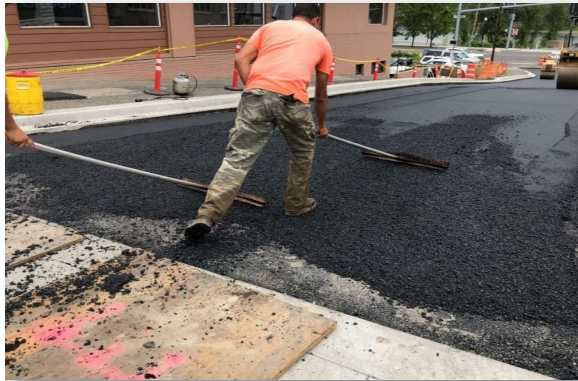

Residential Street Surface Repair

SAFE/SSMP Improvements: SSMP was expanded in 2016 to include maintenance of residential streets, however, no additional funding was identified. Residential Street Surface Repairs provide additional funding for maintenance and rehabilitation of residential streets.

Operating Budget Impact: This project will reduce maintenance operating expenditures related to filling pot holes and other temporary repairs.

Key Departments: Engineering, Public Works

	FY 2025	FY 2026	FY 2027	FY 2028	FY 2029	FY 2030	TOTAL
Capital Cost:							
Construction	\$ 500,000	500,000	500,000	500,000	500,000	500,000	\$ 3,000,000
TOTAL ESTIMATED CAPITAL COST	\$ 500,000	500,000	500,000	500,000	500,000	500,000	\$ 3,000,000
Funding Source:							
SSMP	\$ 500,000	500,000					\$ 1,000,000
Transportation			500,000	500,000	500,000	500,000	2,000,000
TOTAL FUNDING	\$ 500,000	500,000	500,000	500,000	500,000	500,000	\$ 3,000,000

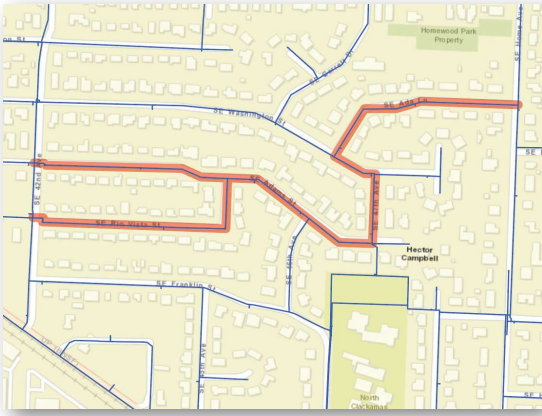

Rio Vista Street - Water System Improvements

Rio Vista Street, Adams Street, 47th Avenue, Washington Street, Ada Lane

Water Improvements: Replace 6-inch water mainline pipe with 1550 feet of 8-inch pipe on Adams Street. Replace 6-inch water mainline pipe with 300 feet of 8-inch pipe on 47th Avenue. Replace 6-inch water mainline pipe with 900 feet of 8-inch pipe on Ada Lane. Replace 4-, 6-inch pipe with 1,010 feet of 8-inch pipe on Rio Vista St. Replace 6-inch water mainline pipe with 190 feet of 8-inch pipe on Washington Street.

Operating Budget Impact: Replacement of aging and undersized water distribution infrastructure will decrease maintenance costs related to emergency repairs of water main breaks.

Key Departments: Engineering, Public Works

	FY 2025	FY 2026	FY 2027	FY 2028	FY 2029	FY 2030	TOTAL
Capital Cost:							
Construction	\$					993,000	\$ 993,000
TOTAL ESTIMATED CAPITAL COST	\$					\$ 993,000	\$ 993,000
Funding Source:							
Water	\$					993,000	\$ 993,000
TOTAL FUNDING	\$					\$ 993,000	\$ 993,000



SAFE Spot Program

SAFE/SSMP Improvements: The Safe Access for Everyone (SAFE) Spot Improvement program will fund small-scale, city identified or community requested transportation safety improvements, (i.e. sidewalk infill or repairs, curb ramp repairs at intersections, adding new crosswalks or other measures).

Operating Budget Impact: This project will increase operating expenditures by increasing the number of curb ramps city wide.

Key Departments: Engineering, Public Works

	FY 2025	FY 2026	FY 2027	FY 2028	FY 2029	FY 2030	TOTAL
Capital Cost:							
Construction	\$ 250,000	100,000					\$ 350,000
TOTAL ESTIMATED CAPITAL COST	\$ 250,000	100,000					\$ 350,000
Funding Source:							
SAFE	\$ 250,000	100,000					\$ 350,000
TOTAL FUNDING	\$ 250,000	100,000					\$ 350,000



Salt & Rock Cover

Transportation Improvements: Salt and rock cover for Public Works to maintain streets during snow and ice weather events, as well as a de-icer mixer.

Operating Budget Impact: The project will not increase operating expenditures.

Key Departments: Public Works

	FY 2025	FY 2026	FY 2027	FY 2028	FY 2029	FY 2030	TOTAL
Capital Cost:							
Construction	\$ 75,000	50,000					\$ 125,000
TOTAL ESTIMATED CAPITAL COST	\$ 75,000	\$ 50,000					\$ 125,000
Funding Source:							
Transportation	\$ 75,000	50,000					\$ 125,000
TOTAL FUNDING	\$ 75,000	\$ 50,000					\$ 125,000

Scott Park

COMING SOON!

LEGEND

1 Stormwater Swale	8 Rock Steppers
2 Stage	9 Picnic Table
3 Bench	10 Sign
4 Blue Rock	11 Drinking Fountain
5 Picnic Area	12 Soft Surface Trail
6 Native Planting	13 Park Entry Sign
7 Paved Platform	

PROJECT **Scott Park Construction** **LOCATION** **10662 SE 21st St.**

START **Spring 2024** **END** **Fall 2024**

NEW AMENITIES play area, rock steppers, drinking fountain, picnic table, new stage

OVERVIEW

Located next to the Ledding Library, the park site is designated as a natural resource area because of the critical habitat it provides for domestic and migratory waterfowl. Scott Park is an important pedestrian destination, and is a frequently used site for community, commercial and civic activities.

CITY OF MILWAUKIE **MORE INFO & UPDATES**
parkprojects.milwaukeeoregon.gov
milwaukeeoregon.gov/park-projects

Scott Park

Master Plan & Implementation

Improvements: Improvements to Scott Park were identified in a revised concept plan. A play area, picnic tables, benches, shelter, drinking fountain, irrigation, and electrical outlets will be installed in the park. Construction bids for Scott Park are \$761,030 not including frontage improvements which are part of another project.

Operating Budget Impact: None

Key Departments: Public Works, Community Development, Planning

	FY 2025	FY 2026	FY 2027	FY 2028	FY 2029	FY 2030	TOTAL
Capital Cost:							
Construction	\$ 366,000						\$ 366,000
TOTAL ESTIMATED CAPITAL COST	\$ 366,000						\$ 366,000
Funding Source:							
General Fund Public Works Admin - ARPA Parks Federal Funds	202,000						\$ 202,000
General Fund Intergovernmental: Metro Parks Bond - Nature in Neighborhoods Grant	30,000						30,000
General Fund Intergovernmental: Oregon State Parks - Local Government Grant Program	134,000						134,000
TOTAL FUNDING	\$ 366,000						\$ 366,000



Sewer Lining Projects

17th Avenue, 34th Avenue, 37th Avenue at Hwy 224, 37th Avenue at Monroe Street, Rio Vista Street, River Road & Stubb Street

Wastewater Improvements:

17th Avenue Sewer Repair: CIPP or line replacement due to substantial cracks/fractures that threaten structural integrity of mainline. MH 1133: length 233.4', upstream depth 4', downstream depth 5.42', number of services 2, diameter 6'.

34th Avenue: Address intrusion of seal material and multiple cracks/fractures that impact integrity of mainline. CO 2344 – 2018: length 257', upstream depth CO', downstream depth 10', number of services 6, diameter 8".

37th Avenue/Hwy 224 Sewer Replacement: Fix bellies in mainline that primarily collect grease from Milwaukie Marketplace. The downstream manhole can be eliminated and tie to 20 feet away. MH 3512–3511: length 324.95', upstream depth 8.42', downstream depth 10.17', number of services 1, diameter 8".

37th Ave at Monroe Street Sewer Replacement: Repair root intrusion in main from mainline joints and lateral connections. MH 2075–2070: length 263', upstream depth 8.9', downstream depth 9.5', number of services 8, diameter 8".

Rio Vista Street Sewer Repair: Full replacement recommended to address root infiltration in mainline. MH 3094 – 3093: length 298.1', upstream depth 9.17', downstream depth 9.42', number of services 10, diameter 8".

River Road Sewer Repair: Address known I&I issues. Joints and lateral connections of sewer mainline are failing and ground water is infiltrating. Eliminating I&I will relieve the Kellogg Creek Treatment Plant, reduce capacity issues, and maintain a water-tight mainline. Medium infiltration of 1-5 gallons per minute. This project may be eligible for 10% costshare from CCSD since it is a project designed to reduce I&I within the city. The project will be evaluated by CCSD for its impact on I&I. CIPP is recommended for the mainline. MH 5052–5051: length 304.0', upstream depth 6.4', downstream depth 6.2', number of services 7, diameter 8".

Roswell Street Sewer Repair: CIPP repair or full replacement to eliminate known I&I issues to reduce groundwater, including those at Kellogg Creek Treatment Plant. Removal of not-in-use laterals recommended. May be eligible for costshare from CCSD. MH 1204 – 1203: length 362.8', upstream depth 8.83', downstream depth 8.33', number of services 8, diameter 8".

Stubb Street Sewer Repair: CIPP repair or full replacement to eliminate known I&I issues, including those at Kellogg Creek Treatment Plant. Recommend removal of laterals not-in-use. May be eligible for costshare from CCSD. MH 1192–1034:

Operating Budget Impact: This project would decrease ongoing operational needs by restoring infrastructure to good condition.

Key Departments: Engineering, Public Works

	FY 2025	FY 2026	FY 2027	FY 2028	FY 2029	FY 2030	TOTAL
Capital Cost:							
Construction	\$ 1,359,000						\$ 1,359,000
TOTAL ESTIMATED CAPITAL COST	\$ 1,359,000						\$ 1,359,000
Funding Source:							
Wastewater	\$ 1,059,000						\$ 1,059,000
Wastewater - I&I Grant Program	300,000						300,000
TOTAL FUNDING	\$ 1,359,000						\$ 1,359,000



Signal and Intersection Upgrades

Transportation Improvements: The city contracts with Clackamas County to install and maintain traffic signals within city limits. Several signals need to be upgraded to meet standards required for ongoing maintenance. City staff will work with the county to identify the highest priority locations and seek out opportunities to leverage additional funding sources.

Operating Budget Impact: None. Clackamas County maintains signals within city limits.

Key Departments: Engineering, Public Works

	FY 2025	FY 2026	FY 2027	FY 2028	FY 2029	FY 2030	TOTAL
Capital Cost:							
Construction	\$ 100,000	100,000	100,000	100,000	100,000	100,000	\$ 600,000
TOTAL ESTIMATED CAPITAL COST	\$ 100,000	100,000	100,000	100,000	100,000	100,000	\$ 600,000
Funding Source:							
Transportation	\$ 100,000	100,000	100,000	100,000	100,000	100,000	\$ 600,000
TOTAL FUNDING	\$ 100,000	100,000	100,000	100,000	100,000	100,000	\$ 600,000

Sparrow Street Improvements

22nd Avenue to the Trolley Trail



- SAFE/SSMP Improvements:** Construct sidewalk and add pedestrian and bicycle crossing between River Road and 25th Avenue. Repave road from 22nd Avenue to River Road and from 25th Avenue to 26th Avenue.
- Water Improvements:** Replace 300 feet of 10-inch water mainline pipe with 16-inch pipe on Sparrow Street.
- Stormwater Improvements:** Improve stormwater facilities through this project.
- Operating Budget Impact:** The project is anticipated to decrease operating expenditures through replacement of aging water infrastructure and increase operating expenditures through construction of new infrastructure, including the multiuse path between River Road and 25th Avenue.
- Key Departments:** Engineering, Public Works

	FY 2025	FY 2026	FY 2027	FY 2028	FY 2029	FY 2030	TOTAL
Capital Cost:							
Planning, Engineering, Design	\$			18,000			\$ 18,000
Construction					281,000		281,000
TOTAL ESTIMATED CAPITAL COST	\$			18,000	281,000		\$ 299,000
Funding Source:							
SSMP	\$			5,000	84,000		\$ 89,000
SAFE				4,000	54,000		58,000
Water				5,000	80,000		85,000
Stormwater				4,000	63,000		67,000
TOTAL FUNDING	\$			18,000	281,000		\$ 299,000



Stanley Reservoir Improvements

American Rescue Plan Act (ARPA) Project

Water Improvements: The Stanley Reservoir is a 3.0 million gallon at-grade welded steel tank constructed in 1970 and is supplied directly from Well #6 on the same site. The coating system on the exterior has failed and large pieces of exterior coating is peeling. The project consists of abrasive blasting the exterior to a near white blast (SP-10) and then coating with a three-coat zinc, epoxy, stripe coat with urethane finish. Due to lead paint on the exterior, the project will require a full containment tent using shrink wrap plastic with scaffolding access around and over the top. The interior of the tank will be coated with a three-coat epoxy system as well. The project will include the installation of a seismic valve and seismic upgrades to roof rafter systems.

Operating Budget Impact: The project will not increase operating expenditures.

Key Departments: Public Works

	FY 2025	FY 2026	FY 2027	FY 2028	FY 2029	FY 2030	TOTAL
Capital Cost:							
Construction	\$ 2,600,000						\$ 2,600,000
TOTAL ESTIMATED CAPITAL COST	\$ 2,600,000						\$ 2,600,000
Funding Source:							
Water - ARPA Federal Funds	\$ 2,600,000						\$ 2,600,000
TOTAL FUNDING	\$ 2,600,000						\$ 2,600,000



Stanley SAFE Improvements

SAFE/SSMP Improvements: Grind and Inlay Stanley Ave between King Rd and Johnson Creek Blvd, construct continuous sidewalk and landscape strip on one side of roadway, upgrade ramps to ADA compliance, install crosswalks, install RRFB at Logus Rd crossing, add box culvert at Johnson Creek crossing for pedestrian access, and add overflow piping from UIC systems at Willow and Hill to Ball-Michel Park.

Operating Budget Impact: None

Key Departments: Engineering, Public Works

	FY 2025	FY 2026	FY 2027	FY 2028	FY 2029	FY 2030	TOTAL
Capital Cost:							
Planning, Engineering, Design	\$ 1,000,000						\$ 1,000,000
Construction		5,000,000					5,000,000
TOTAL ESTIMATED CAPITAL COST	\$ 1,000,000	5,000,000					\$ 6,000,000
Funding Source:							
Other/SRTS Grant	\$ 500,000	5,000,000					\$ 5,500,000
Transportation	500,000						500,000
TOTAL FUNDING	\$ 1,000,000	5,000,000					\$ 6,000,000



Stormwater Capital Maintenance Program

Stormwater Improvements: This yearly project will begin to replace Milwaukie's aging stormwater infrastructure. To complete replacement of the city's system on a 75-year cycle per the 2014 Stormwater Master Plan requires \$780,000 per year. Current funding does not meet planned future replacement costs.

Operating Budget Impact: This project will reduce the operating expenditures by upgrading materials which will require less maintenance.

Key Departments: Public Works

	FY 2025	FY 2026	FY 2027	FY 2028	FY 2029	FY 2030	TOTAL
Capital Cost:							
Construction	\$ 250,000	250,000	250,000	250,000	250,000	250,000	\$ 1,500,000
TOTAL ESTIMATED CAPITAL COST	\$ 250,000	250,000	250,000	250,000	250,000	250,000	\$ 1,500,000
Funding Source:							
Stormwater	\$ 250,000	250,000	250,000	250,000	250,000	250,000	\$ 1,500,000
TOTAL FUNDING	\$ 250,000	250,000	250,000	250,000	250,000	250,000	\$ 1,500,000

Stormwater System Plan

SDC Improvements: The Stormwater System Plan will identify strategies for maintaining adequate maintenance levels for the community. The updated plan will guide capital expenditures for the system and furnish guidance on operational issues and future stormwater rate structures, including:

1. Evaluating and summarizing existing stormwater system and key facilities.
2. Developing demand projections for several scenarios, including buildout, annexation of Dual Interest Areas, and annexation of UGMA.
3. Evaluating existing and future demands to develop a strategy for the city to meet existing and future stormwater management demands.
4. Developing performance and operational criteria under which the stormwater system will be analyzed and future facilities will be formulated.
5. Evaluating existing stormwater management system for seismic and climate resiliency and provide potential solutions.
6. Developing prioritized capital improvements for recommended existing and future stormwater system facilities and an analysis of potential funding.
7. Updating the system development charge rate.

Operating Budget Impact: None
Key Departments: Public Works



	FY 2025	FY 2026	FY 2027	FY 2028	FY 2029	FY 2030	TOTAL
Capital Cost:							
Construction	\$ 275,000	35,000					\$ 310,000
TOTAL ESTIMATED CAPITAL COST	\$ 275,000	35,000					\$ 310,000
Funding Source:							
Stormwater SDC	\$ 275,000	35,000					\$ 310,000
TOTAL FUNDING	\$ 275,000	35,000					\$ 310,000



Street Surface Slurry Seal

Improvements: Treat street surfaces in “good” condition prior to the need for grind and inlay/overlay. By surface sealing worn asphalt, the life of streets can be prolonged.

Operating Budget Impact: This project will reduce maintenance operating expenditures by providing a short-term wearing course on the streets and reduce the potential for potholes and surface cracking.

Key Departments: Engineering, Public Works

	FY 2025	FY 2026	FY 2027	FY 2028	FY 2029	FY 2030	TOTAL
Capital Cost:							
Construction	\$ 250,000	250,000	500,000	250,000	500,000	500,000	\$ 2,250,000
TOTAL ESTIMATED CAPITAL COST	\$ 250,000	250,000	500,000	250,000	500,000	500,000	\$ 2,250,000
Funding Source:							
SSMP	\$ 250,000	250,000	500,000				\$ 1,000,000
Transportation				250,000	500,000	500,000	1,250,000
TOTAL FUNDING	\$ 250,000	250,000	500,000	250,000	500,000	500,000	\$ 2,250,000

Transportation Capital Maintenance Program

Crack Seal/Slurry Seal/Grind & Inlay



Transportation Improvements:

Slurry Seal Program: Treat street surfaces in "good" condition prior to the need for grind and inlay/overlay. By surface sealing worn asphalt, the life of streets can be prolonged.

Crack Seal Program: Provides protection to roadways from possible damage due to water within cracks that form as part of the natural process by sealing them before more expensive measures are required.

Residential Surface Repair: Provides funding for residential surface work to include grind and inlays/overlays.

Operating Budget Impact: This project will reduce maintenance operating expenditures by providing a short-term wearing course on the streets and reduce the potential for potholes and surface cracking.

Key Departments: Public Works

	FY 2025	FY 2026	FY 2027	FY 2028	FY 2029	FY 2030	TOTAL
Capital Cost:							
Construction	\$ 500,000	500,000	500,000	500,000	500,000	500,000	\$ 3,000,000
TOTAL ESTIMATED CAPITAL COST	\$ 500,000	500,000	500,000	500,000	500,000	500,000	\$ 3,000,000
Funding Source:							
Transportation	\$ 500,000	500,000	500,000	500,000	500,000	500,000	\$ 3,000,000
TOTAL FUNDING	\$ 500,000	500,000	500,000	500,000	500,000	500,000	\$ 3,000,000

Transportation System Plan

Transportation System Plan

Transportation Improvements: A city typically reviews and updates its Transportation System Plan (TSP) every 10 years - Milwaukie's TSP was last updated in 2013. The TSP is guided by the city's updated Comprehensive Plan which was adopted in FY 2021. The TSP is the city's long-term plan for transportation improvements to accommodate growth forecasts and projections. Projects identified in it are implemented through the CIP. Updating the TSP fulfills the State of Oregon Transportation Planning Rule requirements for comprehensive transportation planning.

Operating Budget Impact: Unknown

Key Departments: Engineering, Public Works

	FY 2025	FY 2026	FY 2027	FY 2028	FY 2029	FY 2030	TOTAL
Capital Cost:							
Planning, Engineering, Design	\$ 250,000						\$ 250,000
TOTAL ESTIMATED CAPITAL COST	\$ 250,000						\$ 250,000
Funding Source:							
Transportation - ODOT Growth Management Grant	\$ 250,000						\$ 250,000
TOTAL FUNDING	\$ 250,000						\$ 250,000



VFD Improvements

Water Improvements: Install VFDs at water pump stations.

Operating Budget Impact: The project will not increase operating expenditures.

Key Departments: Public Works

	FY 2025	FY 2026	FY 2027	FY 2028	FY 2029	FY 2030	TOTAL
Capital Cost:							
Construction	\$ 50,000	50,000	50,000				\$ 150,000
TOTAL ESTIMATED CAPITAL COST	\$ 50,000	50,000	50,000				\$ 150,000
Funding Source:							
Water	\$ 50,000	50,000	50,000				\$ 150,000
TOTAL FUNDING	\$ 50,000	50,000	50,000				\$ 150,000

Washington Street Area Improvements

27th Avenue, 35th Avenue, 35th Avenue, Washington Street and Edison Street



- SAFE/SSMP Improvements:** 27th Ave (Lake Road to Willard St), 35th Ave (Washington St to Sellwood St), 35th Ave (Washington St to Edison St), and Washington St (27th Ave to 35th Ave) replace sidewalk. Edison St (35th Ave to 37th Ave) add sidewalk and repave road. 27th Ave (Lake Road to Washington St) and Washington St (23rd Ave to 35th Ave) repave road.
- Water Improvements:** Washington Street (28th Ave to Oak St) replace existing 6" water mainline pipe with 8" pipe.
- Wastewater Improvements:** Washington Street: Replace 780 feet of 10" sewer main from manhole 2228 to manhole 2226.
- Stormwater Improvements:** Washington Street: Replace 2,395 feet of 18" storm pipe with 24" pipe from manhole 41183 to manhole 41029. Construct a modular culvert or bridge at Washington St. and 27th Ave for Spring Creek. Add stormwater quality infrastructure.
- Operating Budget Impact:** The project is anticipated to decrease operating expenditures through replacement of aging infrastructure, and increase operating expenditures by adding stormwater quality facilities.
- Key Departments:** Engineering, Public Works

	FY 2025	FY 2026	FY 2027	FY 2028	FY 2029	FY 2030	TOTAL
Capital Cost:							
Planning, Engineering, Design	\$ 200,000						\$ 200,000
Construction	3,465,000						3,465,000
TOTAL ESTIMATED CAPITAL COST	\$ 3,665,000						\$ 3,665,000
Funding Source:							
SSMP	\$ 1,588,000						\$ 1,588,000
SAFE	1,000,000						1,000,000
State Gas Tax FILOC	377,000						377,000
Water	100,000						100,000
Wastewater	100,000						100,000
Stormwater	500,000						500,000
TOTAL FUNDING	\$ 3,665,000						\$ 3,665,000



Wastewater Capital Maintenance Program

Wastewater Improvements: Projects under this program consist of repair of pipe where structural conditions exist or lining is necessary to prevent groundwater infiltration and/or stormwater inflow. Projects are identified based on routine system monitoring.

Operating Budget Impact: Regular maintenance will reduce operating expenditures.

Key Departments: Public Works

	FY 2025	FY 2026	FY 2027	FY 2028	FY 2029	FY 2030	TOTAL
Capital Cost:							
Construction	\$ 50,000	50,000	50,000	50,000	50,000	50,000	\$ 300,000
TOTAL ESTIMATED CAPITAL COST	\$ 50,000	50,000	50,000	50,000	50,000	50,000	\$ 300,000
Funding Source:							
Wastewater	\$ 50,000	50,000	50,000	50,000	50,000	50,000	\$ 300,000
TOTAL FUNDING	\$ 50,000	50,000	50,000	50,000	50,000	50,000	\$ 300,000

Water Automation and Control Upgrades

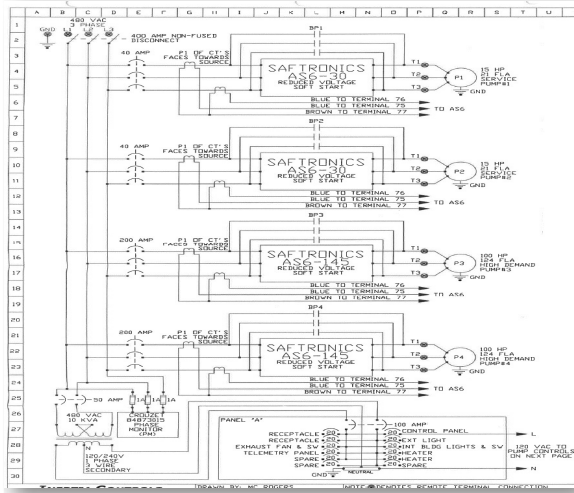

Water Improvements: This project provides for automation and control upgrades replacements at the wells, treatment plants, and pumping facilities.

Operating Budget Impact: Reduce personnel overtime costs.

Key Departments: Public Works

	FY 2025	FY 2026	FY 2027	FY 2028	FY 2029	FY 2030	TOTAL
Capital Cost:							
Construction	\$ 60,000	60,000	50,000	50,000	50,000	50,000	\$ 320,000
TOTAL ESTIMATED CAPITAL COST	\$ 60,000	60,000	50,000	50,000	50,000	50,000	\$ 320,000
Funding Source:							
Water	\$ 60,000	60,000	50,000	50,000	50,000	50,000	\$ 320,000
TOTAL FUNDING	\$ 60,000	60,000	50,000	50,000	50,000	50,000	\$ 320,000

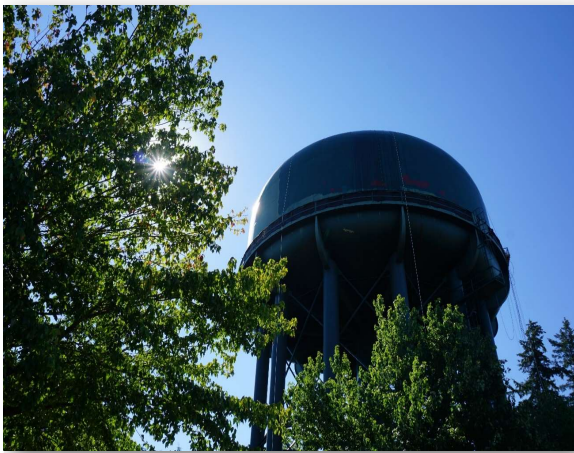

Water Capital Maintenance Program

Water Improvements: Projects under this program consist of repair or replacement of small segments of water main due to structure failure or breaks. Projects are identified based on routine system monitoring for leaks.

Operating Budget Impact: Regular maintenance will reduce operating expenditures.

Key Departments: Public Works

	FY 2025	FY 2026	FY 2027	FY 2028	FY 2029	FY 2030	TOTAL
Capital Cost:							
Construction	\$ 100,000	100,000	100,000	100,000	100,000	100,000	\$ 600,000
TOTAL ESTIMATED CAPITAL COST	\$ 100,000	100,000	100,000	100,000	100,000	100,000	\$ 600,000
Funding Source:							
Water	\$ 100,000	100,000	100,000	100,000	100,000	100,000	\$ 600,000
TOTAL FUNDING	\$ 100,000	100,000	100,000	100,000	100,000	100,000	\$ 600,000

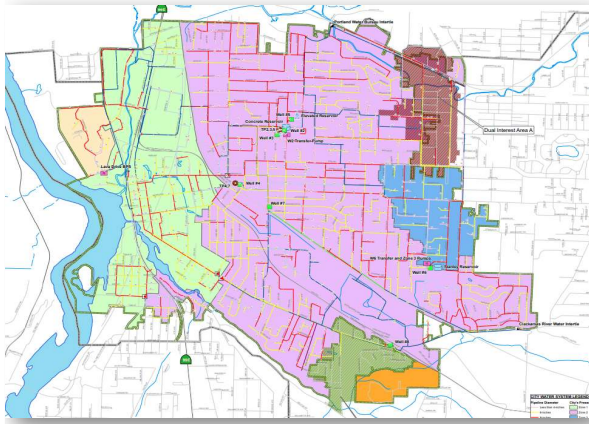

Water Pressure Zone Analysis

Water Improvements: Analysis city wide all pressure zones to ensure coverage and efficient pump needs between pressure zones.

Operating Budget Impact: None

Key Departments: Public Works

	FY 2025	FY 2026	FY 2027	FY 2028	FY 2029	FY 2030	TOTAL
Capital Cost:							
Construction	\$ 50,000						\$ 50,000
TOTAL ESTIMATED CAPITAL COST	\$ 50,000						\$ 50,000
Funding Source:							
Water	\$ 50,000						\$ 50,000
TOTAL FUNDING	\$ 50,000						\$ 50,000



Water System Intertie Evaluation

Water Improvements: Emergency interties are maintained by the City of Portland and Clackamas River Water. The city is interested in evaluating a new intertie with Oak Lodge Water Services on the southwestern boundary of Milwaukie. This intertie could potentially connect to pressure zones 1 or 2.

Operating Budget Impact: Unknown

Key Departments: Public Works

	FY 2025	FY 2026	FY 2027	FY 2028	FY 2029	FY 2030	TOTAL
Capital Cost:							
Planning, Engineering, Design	\$ 75,000						\$ 75,000
Construction		50,000	350,000				\$ 400,000
TOTAL ESTIMATED CAPITAL COST	\$ 75,000	50,000	350,000				\$ 475,000
Funding Source:							
Water	\$ 75,000	50,000	350,000				\$ 475,000
TOTAL FUNDING	\$ 75,000	50,000	350,000				\$ 475,000



Water Transfer Pump Upgrades

Water Improvements: The Water System Master Plan evaluated the city's distribution pumping capacity to determine existing pumping requirements and future requirements. The evaluation determined current deficiencies in the city's ability to meet future maximum day demand plus fire flow as well as a lack of pumping redundancy. This project will upsize selected pumps in pressure zones to provide the necessary capacity and redundancy.

Operating Budget Impact: Larger pumps may impact energy needs, but this may be mitigated by improved pump efficiency.

Key Departments: Public Works

	FY 2025	FY 2026	FY 2027	FY 2028	FY 2029	FY 2030	TOTAL
Capital Cost:							
Planning, Engineering, Design	\$		150,000				\$ 150,000
Construction				1,500,000			1,500,000
TOTAL ESTIMATED CAPITAL COST	\$		\$ 150,000	\$ 1,500,000			\$ 1,650,000
Funding Source:							
Water	\$		150,000	1,500,000			\$ 1,650,000
TOTAL FUNDING	\$		\$ 150,000	\$ 1,500,000			\$ 1,650,000



Water Transmission Main Replacement

Water System Improvements - Harvey Street, Balfour Street, Kelvin Street

Water Improvements: Replace 16-inch water transmission main from the Concrete Reservoir to Zone 2 with 3800 feet of 18-inch pipe.

Operating Budget Impact: Replacement of aging and undersized water distribution infrastructure will decrease maintenance costs related to emergency repairs of water main breaks.

Key Departments: Engineering, Public Works

	FY 2025	FY 2026	FY 2027	FY 2028	FY 2029	FY 2030	TOTAL
Capital Cost:							
Construction	\$					1,786,000	\$ 1,786,000
TOTAL ESTIMATED CAPITAL COST	\$					1,786,000	\$ 1,786,000
Funding Source:							
Water	\$					1,786,000	\$ 1,786,000
TOTAL FUNDING	\$					1,786,000	\$ 1,786,000



Water Treatment Plant

Upper & Lower Upgrades

Water Improvements: This multi year phased project will upgrade components of the water treatment plants (WTP235 and WTP47) and will include generator replacement, automatic transfer switch upgrades, blower replacements upgrades to the stripping towers, addition of a new tower, and a conversion to sodium hypochlorite disinfection system.

Operating Budget Impact: More efficient equipment will reduce energy needs.

Key Departments: Public Works

	FY 2025	FY 2026	FY 2027	FY 2028	FY 2029	FY 2030	TOTAL
Capital Cost:							
Planning, Engineering, Design	\$ 300,000	300,000					\$ 600,000
Construction			450,000	3,500,000	3,500,000		7,450,000
TOTAL ESTIMATED CAPITAL COST	\$ 300,000	300,000	450,000	3,500,000	3,500,000		\$ 8,050,000
Funding Source:							
Water	\$ 300,000	300,000	450,000	3,500,000	3,500,000		\$ 8,050,000
TOTAL FUNDING	\$ 300,000	300,000	450,000	3,500,000	3,500,000		\$ 8,050,000

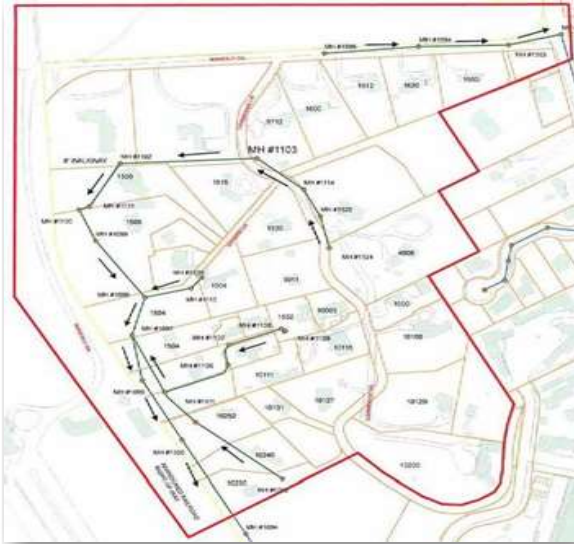

Waverly Heights Sewer System Reconfiguration

Waverly Drive and Cambridge Lane

Wastewater Improvements: Replace sewer pipes within the Waverly Heights area of northwest Milwaukee.

Operating Budget Impact: The project is anticipated to decrease operating expenditures through replacement of aging infrastructure.

Key Departments: Engineering, Public Works

	FY 2025	FY 2026	FY 2027	FY 2028	FY 2029	FY 2030	TOTAL
Capital Cost:							
Planning, Engineering, Design	\$ 350,000						350,000
Land / ROW Acquisition	100,000						100,000
Construction	1,241,000	1,671,000					2,912,000
TOTAL ESTIMATED CAPITAL COST	\$ 1,691,000	1,671,000					\$ 3,362,000
Funding Source:							
Wastewater	\$ 945,000	945,000					\$ 1,890,000
Wastewater SDC	170,000	150,000					320,000
Wastewater - I&I Grant Program	576,000	576,000					1,152,000
TOTAL FUNDING	\$ 1,691,000	1,671,000					\$ 3,362,000

Waverly South Improvements

Lava Drive, Waverly Court, Riverway Lane



- SAFE/SSMP Improvements:** Lava Drive (17th Avenue to Waverly Court) and Waverly Court (Lava Drive to apartment complex entrance at 10110 SE Waverly Court, near the dead end of Waverly Court) replace curb ramps and repave road.
- Water Improvements:** Riverway Lane: Replace 320 feet of 2-inch water mainline pipe with 6-inch pipe to address hydraulic, structural, and water quality issues.
- Wastewater Improvements:** Riverway Lane: Pipe burst or replace 220 feet of 10-inch sewer pipe from manhole 1087 to manhole 1086 to fix root intrusion in portions of the mainline.
- Stormwater Improvements:** Improve stormwater facilities through this project.
- Operating Budget Impact:** The project is anticipated to decrease operating expenditures through replacement of aging infrastructure.
- Key Departments:** Engineering, Public Works

	FY 2025	FY 2026	FY 2027	FY 2028	FY 2029	FY 2030	TOTAL
Capital Cost:							
Construction	819,000						\$ 819,000
TOTAL ESTIMATED CAPITAL COST	\$ 819,000						\$ 819,000
Funding Source:							
SSMP	\$ 359,000						\$ 359,000
SAFE	84,000						\$ 84,000
Water	162,000						\$ 162,000
Wastewater	202,000						\$ 202,000
Stormwater	12,000						\$ 12,000
TOTAL FUNDING	\$ 819,000						\$ 819,000



Well 4 Reconditioning

Water Improvements: Water wells require regular maintenance to ensure adequate water flow and continued drinking water safety, and should be professionally inspected by a water well contractor every 10 years. As a well ages, the rate at which water may be pumped (commonly referred to as well yield, flow, or performance) tends to decrease. Reduced well yield over time can be related to changes in the well itself including: incrustation from mineral deposits, bio-fouling by the growth of microorganisms, physical plugging of “aquifer” (the saturated layer of sand, gravel, or rock through which water is transmitted) by sediment, sand pumping, well screen or casing corrosion, and pump damage.

Well #4 is located at the intersection of Monroe Street, Railroad Avenue, and Oak Street adjacent to Water Treatment Plant 47. It pumps approximately 605 gpm directly into Tower #4 at the treatment plant TP47 site. This project consists of inspecting by video, disinfecting, and reconditioning the well.

Operating Budget Impact: None

Key Departments: Public Works

	FY 2025	FY 2026	FY 2027	FY 2028	FY 2029	FY 2030	TOTAL
Capital Cost:							
Construction	\$	60,000					\$ 60,000
TOTAL ESTIMATED CAPITAL COST	\$	60,000					\$ 60,000
Funding Source:							
Water	\$	60,000					\$ 60,000
TOTAL FUNDING	\$	60,000					\$ 60,000



Well 5 Improvements

Water Improvements: Water wells require regular maintenance to ensure adequate water flow and continued drinking water safety, and should be professionally inspected by a water well contractor every 10 years. As a well ages, the rate at which water may be pumped (commonly referred to as well yield, flow, or performance) tends to decrease. Reduced well yield over time can be related to changes in the well itself including: incrustation from mineral deposits, bio-fouling by the growth of microorganisms, physical plugging of "aquifer" (the saturated layer of sand, gravel, or rock through which water is transmitted) by sediment, sand pumping, well screen or casing corrosion, and pump damage.

The old Well #1 building requires minor repairs, weatherproofing, and rehabilitation. This building is located near the base of the elevated storage tower and houses the communication equipment for the Supervisory Control and Data Acquisition (SCADA) system.

Well #5 is located north of the intersection of Harvey Street and 40th Avenue, adjacent to the Elevated Storage Reservoir and is part of the Well #2, #3, and #5 well field. It pumps approximately 605 gallons per minute directly into Tower #5 at the treatment plan TP235 site. This project consists of repairing the existing building which is in poor condition, replacing and upgrading the electrical panel and motor start, and inspecting and reconditioning the well.

Operating Budget Impact: None

Key Departments: Public Works

	FY 2025	FY 2026	FY 2027	FY 2028	FY 2029	FY 2030	TOTAL
Capital Cost:							
Construction	\$ 50,000	600,000					\$ 650,000
TOTAL ESTIMATED CAPITAL COST	\$ 50,000	600,000					\$ 650,000
Funding Source:							
Water	\$ 50,000	600,000					\$ 650,000
TOTAL FUNDING	\$ 50,000	600,000					\$ 650,000



Well 6 Pump Station Improvements

Water Improvements: Replace the Well 6 Pump Station with two (2) 2,000 GPM pumps at Stanley, per Water System Plan P3.

Operating Budget Impact: The project will not increase operating expenditures.

Key Departments: Public Works

	FY 2025	FY 2026	FY 2027	FY 2028	FY 2029	FY 2030	TOTAL
Capital Cost:							
Construction	\$		50,000				\$ 50,000
TOTAL ESTIMATED CAPITAL COST	\$		50,000				\$ 50,000
Funding Source:							
Water	\$		50,000				\$ 50,000
TOTAL FUNDING	\$		50,000				\$ 50,000



Well 6 & 7 Reconditioning Project

Water Improvements: Water wells require regular maintenance to ensure adequate water flow and continued drinking water safety, and should be professionally inspected by a water well contractor every 10 years. As a well ages, the rate at which water may be pumped (commonly referred to as well yield, flow, or performance) tends to decrease. Reduced well yield over time can be related to changes in the well itself including: incrustation from mineral deposits, bio-fouling by the growth of microorganisms, physical plugging of “aquifer” (the saturated layer of sand, gravel, or rock through which water is transmitted) by sediment, sand pumping, well screen or casing corrosion, and pump damage.

Well #7 is located near the intersection of Washington Street and 37th Avenue, and pumps approximately 1,120 gpm directly into Tower at Treatment Plant 47. Well #7 has a sand separator and onsite back-up generator. Well #6 is located near the Stanley Reservoir at Stanley Avenue, pumps approximately 670 gpm, and is the primary well for the 3rd pressure zone. This project consists of inspecting by video, disinfecting, and reconditioning the wells pump motor, and pump as necessary.

Operating Budget Impact: None

Key Departments: Public Works

	FY 2025	FY 2026	FY 2027	FY 2028	FY 2029	FY 2030	TOTAL
Capital Cost:							
Construction	\$	60,000	60,000				\$ 120,000
TOTAL ESTIMATED CAPITAL COST	\$	60,000	60,000				\$ 120,000
Funding Source:							
Water	\$	60,000	60,000				\$ 120,000
TOTAL FUNDING	\$	60,000	60,000				\$ 120,000



Well 8

Water Improvements: Well 8 pumps between 300 and 700 gallons per minute (gpm) directly into the Zone 2 distribution system and has an active water right certified through the Oregon Water Resources Department of 727 gpm. The well water is treated with chlorine which is injected upstream of the buried chlorine contact tank. The well is experiencing issues with excessive iron in the water its drawing and has been out of operation for about 7 years. The well will undergo both a mechanical and chemical cleaning.

Operating Budget Impact: Unknown

Key Departments: Public Works

	FY 2025	FY 2026	FY 2027	FY 2028	FY 2029	FY 2030	TOTAL
Capital Cost:							
Construction	\$ 300,000						\$ 300,000
TOTAL ESTIMATED CAPITAL COST	\$ 300,000						\$ 300,000
Funding Source:							
Water	\$ 300,000						\$ 300,000
TOTAL FUNDING	\$ 300,000						\$ 300,000



Well House HVAC Upgrades

Water Improvements: This project focuses on providing upgraded heating, cooling and ventilations systems at the well sites. The current ventilation systems are inadequate during the summer and during times when the system is operating under emergency power. The upgrades include improved venting on the doors and improved exhaust fans.

Operating Budget Impact: The new systems be more efficient and reduce costs and protect well house electrical systems.

Key Departments: Public Works

	FY 2025	FY 2026	FY 2027	FY 2028	FY 2029	FY 2030	TOTAL
Capital Cost:							
Construction	\$ 25,000	25,000	50,000	50,000			\$ 150,000
TOTAL ESTIMATED CAPITAL COST	\$ 25,000	25,000	50,000	50,000			\$ 150,000
Funding Source:							
Water	\$ 25,000	25,000	50,000	50,000			\$ 150,000
TOTAL FUNDING	\$ 25,000	25,000	50,000	50,000			\$ 150,000

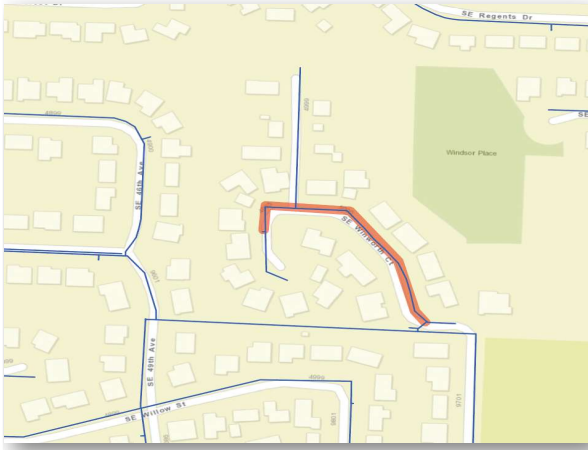

Winworth Court - Water System Improvements

Water Improvements: Replace 4-inch water mainline pipe with 500 feet of 8-inch pipe on Winworth Court.

Operating Budget Impact: Replacement of aging and undersized water distribution infrastructure will decrease maintenance costs related to emergency repairs of water main breaks.

Key Departments: Engineering, Public Works

	FY 2025	FY 2026	FY 2027	FY 2028	FY 2029	FY 2030	TOTAL
Capital Cost:							
Construction	\$					125,000	\$ 125,000
TOTAL ESTIMATED CAPITAL COST	\$					125,000	\$ 125,000
Funding Source:							
Water	\$					125,000	\$ 125,000
TOTAL FUNDING	\$					125,000	\$ 125,000



RS412

CHAPTER 2

OPERATIONAL FACILITIES AND EQUIPMENT

The projects and capital needs within this chapter are necessary to keep the existing city facilities and operational needs maintained and up to date. Projects within this chapter include facility improvements, vehicle replacements, information technology upgrades, and other enhancements necessary to extend the useful life of existing city facilities and equipment.

OVERVIEW

The General Fund is the main operating fund of the city and encompasses several funds that include internal services and external services such as the library and police departments.

Revenue sources for the General Fund include property taxes, franchise fees, business taxes, permitting fees not related to building, and intergovernmental sources that are either ongoing or one-time funds. Many of the capital improvement costs are related to facility upgrades and maintenance improvements, however, there are costs associated with technical equipment and vehicles or fleet. Fleet maintenance is within the General Fund; however, the individual funds and departments allocated the costs of new vehicles within those budgets.

Below is an outline of costs by type:

FUND	FY 2025	FY 2026	FY 2027	FY 2028	FY 2029	FY 2030	TOTAL
General	\$ 1,750,000	412,000	1,706,000	505,000	990,000	360,000	\$ 5,723,000
Building	50,000	50,000					100,000
Transportation	141,000	123,000	100,000	50,000	150,000	50,000	614,000
Water	170,000	38,000	180,000	50,000	85,000	100,000	623,000
Wastewater	486,000		165,000	115,000	535,000	500,000	1,801,000
Stormwater	256,000	885,000	205,000	295,000	450,000	550,000	2,641,000
TOTAL	\$2,853,000	1,508,000	2,356,000	1,015,000	2,210,000	1,560,000	\$ 11,502,000

SUMMARY BY PROJECT & FUND

Facility Improvements

GENERAL FUND - FACILITIES

PAGE	PROJECT NAME	FY 2025	FY 2026	FY 2027	FY 2028	FY 2029	FY 2030	TOTAL
90	City Hall Badge Readers	\$ 20,000						\$ 20,000
90	City Hall Window Seal Replacement	30,000						30,000
91	Citywide HVAC Controls	100,000						100,000
91	Johnson Creek Campus Solar Array Installation	475,000						475,000
92	Ledding Library Bollard Installation	20,000						20,000
92	Public Safety Building Boiler	15,000						15,000
93	Public Works Admin Building Bathroom Renovation:	85,000						85,000
93	Gutter Installation		45,000					45,000
94	Public Works Parking Lot Repair		30,000					30,000
94	Public Safety Building Roof		30,000					30,000
95	Bertman House Deconstruction			120,000				120,000
95	Bertman Property Landscape Improvements			35,000				35,000
96	City Hall Fence			28,000				28,000
96	Citywide EV Chargers			65,000	65,000	65,000	65,000	260,000
97	Feasibility Study			45,000				45,000
97	HVAC Electric Units Installation			650,000	65,000	650,000	65,000	1,430,000
98	Johnson Creek Campus Fence Line Adjustment			35,000				35,000
98	Johnson Creek Campus Barn Installation			85,000				85,000
99	Public Facility Electrical Upgrades			50,000				50,000
99	Public Safety Building Carpet			48,000				48,000
100	Public Safety Building Parking Lot Repair			15,000	50,000			65,000
100	Public Works Admin Building Breakroom Upgrades			35,000				35,000
101	Public Works Operations Cabinet Installation			50,000				50,000
101	ADA Improvements				95,000	50,000	50,000	195,000
102	Public Safety Building Exterior Paint				50,000			50,000
SUBTOTAL FACILITY IMPROVEMENTS / GENERAL FUND - FACILITIES		\$ 745,000	105,000	1,261,000	325,000	765,000	180,000	\$3,381,000

SEISMIC REHABILITATION OREGON GRANT

PAGE	PROJECT NAME	FY 2025	FY 2026	FY 2027	FY 2028	FY 2029	FY 2030	TOTAL
102	Public Safety Building Seismic Retrofit	\$ 500,000						\$ 500,000
SUBTOTAL / SEISMIC REHABILITATION OREGON GRANT - FACILITIES		\$ 500,000						\$ 500,000

GENERAL FUND - POLICE

PAGE	PROJECT NAME	FY 2025	FY 2026	FY 2027	FY 2028	FY 2029	FY 2030	TOTAL
103	Public Safety Building Detectives Office	\$ 15,000	15,000					\$ 30,000
SUBTOTAL PSB IMPROVEMENTS / GENERAL FUND - POLICE		\$ 15,000	15,000					\$ 30,000

TOTAL GENERAL FUND (MULTIPLE DEPARTMENTS)		\$1,260,000	120,000	1,261,000	325,000	765,000	180,000	\$3,911,000
--	--	--------------------	----------------	------------------	----------------	----------------	----------------	--------------------

Information Technology

GENERAL FUND - INFORMATION TECHNOLOGY

PAGE	PROJECT NAME	FY 2025	FY 2026	FY 2027	FY 2028	FY 2029	FY 2030	TOTAL
104	Police MDC Refresh	\$ 35,000	35,000					\$ 70,000
104	Enterprise Firewall & Servers Refresh	145,000						145,000
105	Camera Storage & Server Refresh			50,000				50,000
SUBTOTAL GENERAL FUND - INFORMATION TECHNOLOGY		\$ 180,000	35,000	50,000				\$ 265,000

UTILITY FUNDS - SCADA EQUIPMENT REFRESH

PAGE	PROJECT NAME	FY 2025	FY 2026	FY 2027	FY 2028	FY 2029	FY 2030	TOTAL
105	SCADA Equipment Refresh - Water	\$		100,000				\$ 100,000
105	SCADA Equipment Refresh - Wastewater			100,000				100,000
SUBTOTAL UTILITY FUNDS		\$		200,000				\$ 200,000
TOTAL INFORMATION TECHNOLOGY (MULTIPLE FUNDS)		\$ 180,000	35,000	250,000				\$ 465,000

Vehicles & Equipment

PAGE	FUND	FY 2025	FY 2026	FY 2027	FY 2028	FY 2029	FY 2030	TOTAL
106	General	\$ 310,000	257,000	395,000	180,000	225,000	180,000	\$ 1,547,000
106	Building	50,000	50,000					100,000
106	Transportation	141,000	123,000	100,000	50,000	150,000	50,000	614,000
107	Water	170,000	38,000	80,000	50,000	85,000	100,000	523,000
107	Wastewater	486,000		65,000	115,000	535,000	500,000	1,701,000
107	Stormwater	256,000	885,000	205,000	295,000	450,000	550,000	2,641,000
TOTAL VEHICLES & EQUIPMENT (MULTIPLE FUNDS)		\$1,413,000	1,353,000	845,000	690,000	1,445,000	1,380,000	\$7,126,000

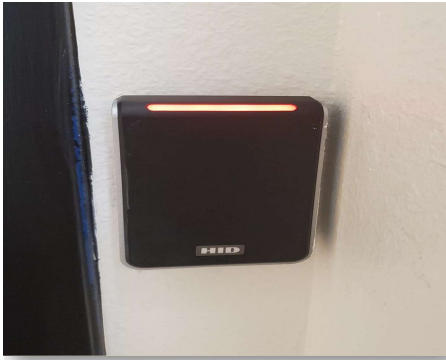

City Hall Badge Readers

Improvements: City Hall requires five (5) new badge readers. Two (2) badge readers at the janitorial closets on the second floor, and one (1) badge reader each at the fire rise door, the City Recorder department on the third floor, and the basement of the west stairwell for staff access.

Operating Budget Impact: None

Key Departments: Public Works, Facilities, HR, OCR, IT

	FY 2025	FY 2026	FY 2027	FY 2028	FY 2029	FY 2030	TOTAL
Funding Source:							
General Fund - Facilities	\$	20,000					\$ 20,000
TOTAL FUNDING	\$	20,000					\$ 20,000



City Hall Window Seal Replacement

Improvements: City Hall building will require window seal replacements to address failed seams.

Operating Budget Impact: None

Key Departments: Facilities

	FY 2025	FY 2026	FY 2027	FY 2028	FY 2029	FY 2030	TOTAL
Funding Source:							
General Fund - Facilities	\$	30,000					\$ 30,000
TOTAL FUNDING	\$	30,000					\$ 30,000



Citywide HVAC Controls

Improvements: Citywide HVAC controls will require full heating and cooling integration to be run on the same HVAC controls for best efficiency.

Operating Budget Impact: None

Key Departments: Public Works, Facilities

	FY 2025	FY 2026	FY 2027	FY 2028	FY 2029	FY 2030	TOTAL
Funding Source:							
General Fund - Facilities	\$	100,000					\$ 100,000
TOTAL FUNDING	\$	100,000					\$ 100,000



Johnson Creek Campus Solar Array Installation

Improvements: Installation of a solar array at the Johnson Creek Campus to offset energy usage and further the city's decarbonization goals. It is anticipated that the installation would be a roof top installation and would take advantage of the open roof space at the campus.

Operating Budget Impact: These costs will be split between the utility funds occupying the Johnson Creek Building.

Key Departments: Public Works, Facilities, Utility Funds

	FY 2025	FY 2026	FY 2027	FY 2028	FY 2029	FY 2030	TOTAL
Capital Cost:							
Planning, Engineering, Design	\$	75,000					\$ 75,000
Construction		400,000					400,000
TOTAL ESTIMATED CAPITAL COST	\$	475,000					\$ 475,000
Funding Source:							
General Fund - Facilities	\$	100,000					\$ 100,000
General Fund Facilities: Senate Bill 5506 General Fund Grant		375,000					375,000
TOTAL FUNDING	\$	475,000					\$ 475,000

Ledding Library Bollard Installation



Improvements: The project would involve the installation of 8 bollards below and above surface level to assist with safety.

Operating Budget Impact: None

Key Departments: Public Works, Facilities, Building, Library

	FY 2025	FY 2026	FY 2027	FY 2028	FY 2029	FY 2030	TOTAL
Funding Source:							
General Fund - Facilities	\$	20,000					\$ 20,000
TOTAL FUNDING	\$	20,000					\$ 20,000



Public Safety Building Boiler

Improvements: The Public Safety Building gas boiler requires new electric boiler.

Operating Budget Impact: None

Key Departments: Public Works, Facilities, Police Department

	FY 2025	FY 2026	FY 2027	FY 2028	FY 2029	FY 2030	TOTAL
Funding Source:							
General Fund - Facilities	\$	15,000					\$ 15,000
TOTAL FUNDING	\$	15,000					\$ 15,000

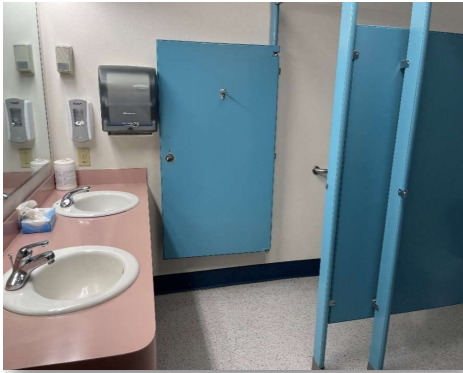

Public Works Admin Building Bathroom Renovations

Improvements: Public Works Administration Building renovation of two bathrooms to include ADA design.

Operating Budget Impact: None

Key Departments: Public Works, Facilities

	FY 2025	FY 2026	FY 2027	FY 2028	FY 2029	FY 2030	TOTAL
Funding Source:							
General Fund - Facilities	\$	85,000					\$ 85,000
TOTAL FUNDING	\$	85,000					\$ 85,000



Gutter Installation

Improvements: The Public Works Operations Building and Harvey & 40th require the removal of old leaking gutters and installation of new gutters.

Operating Budget Impact: None

Key Departments: Public Works, Facilities

	FY 2025	FY 2026	FY 2027	FY 2028	FY 2029	FY 2030	TOTAL
Funding Source:							
General Fund - Facilities	\$	45,000					\$ 45,000
TOTAL FUNDING	\$	45,000					\$ 45,000



Public Works Parking Lot Repair

Improvements: The back parking lot at the Public Works require crack sealing, slurry sealing, and re-striping.

Operating Budget Impact: None

Key Departments: Public Works, Facilities

	FY 2025	FY 2026	FY 2027	FY 2028	FY 2029	FY 2030	TOTAL
Funding Source:							
General Fund - Facilities	\$	30,000					\$ 30,000
TOTAL FUNDING	\$	30,000					\$ 30,000



Public Safety Building Roof

Improvements: Remove existing roof material and install new to stop roof leaks at the Public Safety Building.

Operating Budget Impact: None

Key Departments: Public Works, Facilities, Police Department

	FY 2025	FY 2026	FY 2027	FY 2028	FY 2029	FY 2030	TOTAL
Funding Source:							
General Fund - Facilities	\$	30,000					\$ 30,000
TOTAL FUNDING	\$	30,000					\$ 30,000



Bertman House Deconstruction

Improvements: The project would involve deconstruction of the Bertman house, removal of foundation, utilities, construction of a swift tower, and landscape restoration.

Operating Budget Impact: None

Key Departments: Public Works, Facilities

	FY 2025	FY 2026	FY 2027	FY 2028	FY 2029	FY 2030	TOTAL
Funding Source:							
General Fund - Facilities	\$		120,000				\$ 120,000
TOTAL FUNDING	\$		120,000				\$ 120,000



Bertman Property Landscape Improvements

Improvements: Bertman Property landscape improvements will support drainage with new drains and foliage.

Operating Budget Impact: None

Key Departments: Public Works, Streets, Facilities

	FY 2025	FY 2026	FY 2027	FY 2028	FY 2029	FY 2030	TOTAL
Funding Source:							
General Fund - Facilities	\$		35,000				\$ 35,000
TOTAL FUNDING	\$		35,000				\$ 35,000



City Hall Fence

Improvements: City Hall garage installation of a new tall black Montage Plus fence with two (2) ADA gates and badge access to secure city vehicles.

Operating Budget Impact: None

Key Departments: Facilities, Fleet

	FY 2025	FY 2026	FY 2027	FY 2028	FY 2029	FY 2030	TOTAL
Funding Source:							
General Fund - Facilities	\$		28,000				\$ 28,000
TOTAL FUNDING	\$		28,000				\$ 28,000



Citywide EV Chargers

Improvements: Installing EV Charging stations at City Hall and expanding charging infrastructure at other buildings to L2 and faster to accommodate a growing public need for these services.

Operating Budget Impact: None

Key Departments: Public Works, Facilities

	FY 2025	FY 2026	FY 2027	FY 2028	FY 2029	FY 2030	TOTAL
Funding Source:							
General Fund - Facilities	\$		65,000	65,000	65,000	65,000	\$ 260,000
TOTAL FUNDING	\$		65,000	65,000	65,000	65,000	\$ 260,000



Feasibility Study

Improvements: City Council Resolution No. 80-2022 to decarbonize city-owned and city-financed buildings. The city manager is directed to inventory city-owned facilities that currently use natural gas and evaluate the feasibility of retrofitting those facilities to cease using natural gas, with a priority of decarbonization where feasible. The inventory and evaluation will make use existing reports and data to prepare preliminary feasibility recommendations.

Operating Budget Impact: None

Key Departments: Public Works, Facilities, City Manager

	FY 2025	FY 2026	FY 2027	FY 2028	FY 2029	FY 2030	TOTAL
Funding Source:							
General Fund - Facilities	\$		45,000				\$ 45,000
TOTAL FUNDING	\$		45,000				\$ 45,000



HVAC Electric Units Installation

Improvements: Installation of new fully-electric HVAC systems to offset energy usage and further the city's decarbonization goals. It is anticipated that the installation would be mix of roof top and ground level units.

Operating Budget Impact: None

Key Departments: Public Works and Facilities

	FY 2025	FY 2026	FY 2027	FY 2028	FY 2029	FY 2030	TOTAL
Funding Source:							
General Fund - Facilities	\$		650,000	65,000	650,000	65,000	\$1,430,000
TOTAL FUNDING	\$		650,000	65,000	650,000	65,000	\$1,430,000

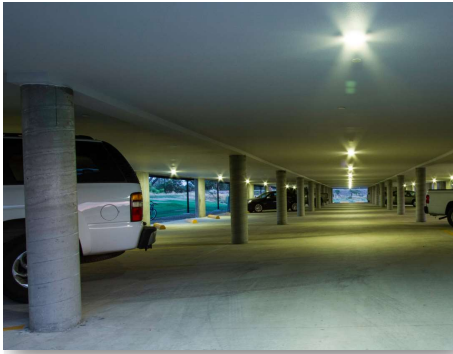

Johnson Creek Campus Fence Line Adjustment

Improvements: The Johnson Creek Campus fence line adjustment will include more fencing and two (2) badge readers to support activities at the campus.

Operating Budget Impact: None

Key Departments: Public Works, Facilities, Fleet

	FY 2025	FY 2026	FY 2027	FY 2028	FY 2029	FY 2030	TOTAL
Funding Source:							
General Fund - Facilities	\$		35,000				\$ 35,000
TOTAL FUNDING	\$		35,000				\$ 35,000



Johnson Creek Campus Barn Installation

Improvements: Installation of a vehicle and supplies barn at the Johnson Creek Campus to accommodate the city's Fleet operational goals.

Operating Budget Impact: None

Key Departments: Public Works, Facilities and Utility Funds

	FY 2025	FY 2026	FY 2027	FY 2028	FY 2029	FY 2030	TOTAL
Funding Source:							
General Fund - Facilities	\$		85,000				\$ 85,000
TOTAL FUNDING	\$		85,000				\$ 85,000



Public Facility Electrical Upgrades

Improvements: Electrical improvements to public facilities that will support access and local markets.

Operating Budget Impact: None

Key Departments: Public Works and Facilities

	FY 2025	FY 2026	FY 2027	FY 2028	FY 2029	FY 2030	TOTAL
Funding Source:							
General Fund - Facilities	\$		50,000				\$ 50,000
TOTAL FUNDING	\$		50,000				\$ 50,000



Public Safety Building Carpet

Improvements: The carpet on the second floor of the Public Safety Building requires replacement.

Operating Budget Impact: None

Key Departments: Public Works, Facilities, Police Department

	FY 2025	FY 2026	FY 2027	FY 2028	FY 2029	FY 2030	TOTAL
Funding Source:							
General Fund - Facilities	\$		48,000				\$ 48,000
TOTAL FUNDING	\$		48,000				\$ 48,000



Public Safety Building Parking Lot Repair

Improvements: The parking lots at the Public Safety Building require crack sealing, slurry sealing, and re-striping.

Operating Budget Impact: None

Key Departments: Public Works, Facilities and Police Department

	FY 2025	FY 2026	FY 2027	FY 2028	FY 2029	FY 2030	TOTAL
Funding Source:							
General Fund - Facilities	\$		15,000	50,000			\$ 65,000
TOTAL FUNDING	\$		15,000	50,000			\$ 65,000



Public Works Admin Building Breakroom Upgrades

Improvements: The Public Works Administration Building breakroom upgrades will include new furniture for staff, counterspace and a coffee bar.

Operating Budget Impact: None

Key Departments: Public Works, Facilities, Fleet

	FY 2025	FY 2026	FY 2027	FY 2028	FY 2029	FY 2030	TOTAL
Funding Source:							
General Fund - Facilities	\$		35,000				\$ 35,000
TOTAL FUNDING	\$		35,000				\$ 35,000



Public Works Operations Cabinet Installation

Improvements: Installation of six (6) new cabinets at the Public Works Operations Building to help staff with storage and organization.

Operating Budget Impact: None

Key Departments: Public Works and Facilities

	FY 2025	FY 2026	FY 2027	FY 2028	FY 2029	FY 2030	TOTAL
Funding Source:							
General Fund - Facilities	\$		50,000				\$ 50,000
TOTAL FUNDING	\$		50,000				\$ 50,000



ADA Improvements

Improvements: Citywide ADA improvements will support access.

Operating Budget Impact: None

Key Departments: Public Works, Streets, Facilities

	FY 2025	FY 2026	FY 2027	FY 2028	FY 2029	FY 2030	TOTAL
Funding Source:							
General Fund - Facilities	\$			95,000	50,000	50,000	\$ 145,000
TOTAL FUNDING	\$			95,000	50,000	50,000	\$ 145,000



Public Safety Building Exterior Paint

Improvements: The exterior walls of the Public Safety Building will require painting.

Operating Budget Impact: None

Key Departments: Public Works, Facilities, Police Department

	FY 2025	FY 2026	FY 2027	FY 2028	FY 2029	FY 2030	TOTAL
Funding Source:							
General Fund - Facilities	\$			50,000			\$ 50,000
TOTAL FUNDING	\$			50,000			\$ 50,000



Public Safety Building Seismic Retrofit

Improvements: The Public Safety Building is designated as an Emergency Operations Center and is required to meet certain seismic requirements. The city obtained preliminary design and assessment documents, and was awarded a state rehabilitation grant to perform a retrofit through the Seismic Rehabilitation Grant Program by December 2024.

Operating Budget Impact: None

Key Departments: Public Works, Facilities and Police Department

	FY 2025	FY 2026	FY 2027	FY 2028	FY 2029	FY 20230	TOTAL
Capital Cost:							
Construction	\$	500,000					\$ 500,000
TOTAL ESTIMATED CAPITAL COST	\$	500,000					\$ 500,000
Funding Source:							
General Fund Facilities: Oregon Seismic Rehabilitation Grant	\$	500,000					500,000
TOTAL FUNDING	\$	500,000					\$ 500,000

Public Safety Building Detectives Office



Improvements: A phased improvement of the detectives office is planned to replace furniture, chairs, cubicles, storage, and shelving. Several items are used or in various states of disrepair, and the improvements will provide a more functional workspace, improved efficiencies, and optimized shared space. Also, new technology has rendered some current configurations obsolete so additional upgrades are required, including built-in charging stations and integrated cable management. These capital improvements will not only enhance the aesthetic appeal but contribute meaningfully to workplace efficiency and employee well-being.

Operating Budget Impact: None

Key Departments: Police Department

	FY 2025	FY 2026	FY 2027	FY 2028	FY 2029	FY 2030	TOTAL
Funding Source:							
General Fund - Police	\$ 15,000	15,000					\$ 30,000
TOTAL FUNDING	\$ 15,000	15,000					\$ 30,000

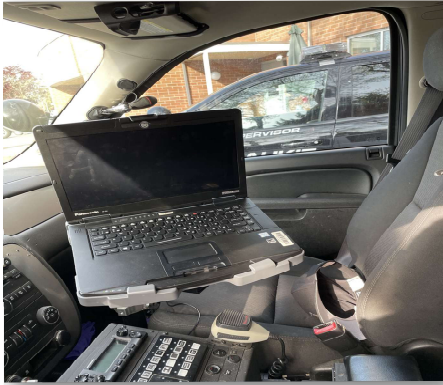

Police MDC Refresh

Improvements: Police Mobile Data Computers (MDC) are due for replacement based upon a lifecycle of approximately 5 years. Replacement will update to the latest operating system in order to maintain security updates well into the future. This refresh is lifecycle management.

Operating Budget Impact: None

Key Departments: Information Technology

	FY 2025	FY 2026	FY 2027	FY 2028	FY 2029	FY 2030	TOTAL
Funding Source:							
General Fund - Information Technology	\$ 35,000	35,000					\$ 70,000
TOTAL FUNDING	\$ 35,000	35,000					\$ 70,000

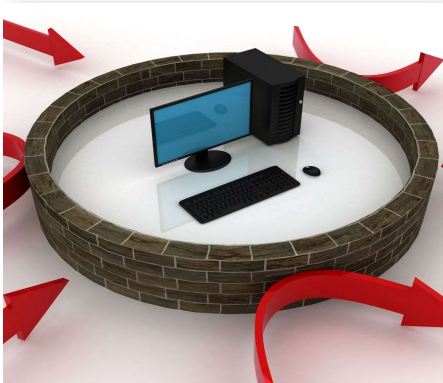

Enterprise Firewall & Servers Refresh

Improvements: One component for network security and remote access is with a robust enterprise firewall. The lifecycle replacement of a firewall is every four years. The Enterprise servers are the foundation of what applications exist and how staff complete their work. This refresh is lifecycle management.

Operating Budget Impact: None

Key Departments: Information Technology

	FY 2025	FY 2026	FY 2027	FY 2028	FY 2029	FY 2030	TOTAL
Funding Source:							
General Fund - Information Technology Enterprise Firewall Refresh	\$ 85,000						\$ 85,000
General Fund - Information Technology Servers Refresh		60,000					60,000
TOTAL FUNDING	\$ 145,000						\$ 145,000



Camera Storage & Server Refresh

Improvements: CCTV security cameras are one of the security measures used by the city to deter crime in and around city facilities. All camera recordings are stored in city-owned data storage. Lifecycle replacement of servers and data storage is five years.

Operating Budget Impact: None

Key Departments: Information Technology

	FY 2025	FY 2026	FY 2027	FY 2028	FY 2029	FY 2030	TOTAL
Funding Source:							
General Fund - Information Technology	\$		50,000				\$ 50,000
TOTAL FUNDING	\$		50,000				\$ 50,000



SCADA Equipment Refresh

Improvements: The city's SCADA system is on a lifecycle replacement schedule. This includes replacement of existing firewalls, servers, storage, and other devices to keep the system operational and secure.

Operating Budget Impact: None

Key Departments: Information Technology, Water, Wastewater

	FY 2025	FY 2026	FY 2027	FY 2028	FY 2029	FY 2030	TOTAL
Funding Source:							
Water	\$		100,000				\$ 100,000
Wastewater			100,000				100,000
TOTAL FUNDING	\$		200,000				\$ 200,000

Vehicles & Equipment



Improvements: The Public Works Fleet Division works constantly to ensure the profile of the fleet matches the needs, goals, and budgetary restrictions of the organization. The fleet needs to be right-sized as well as regularly evaluated for reduction or addition. Vehicles are examined through a number of filters to establish need:

- Is the vehicle near the end of its useful life (typically 8-10 years or 100,000 miles)?
- How many miles per year does the vehicle travel? Is it low-use and could it be combined with another vehicle?
- What is the vehicle's condition? Are repair costs anticipated? Is the vehicle's value approaching 30% of residual value?
- Does the vehicle serve a critical function (snowplow, emergency response, etc.)?
- Is the vehicle task-specific? Could functions be subcontracted at a lower cost than the purchase/maintenance of a vehicle?
- Is it a passenger or light-duty vehicle that could be replaced with an EV or hybrid?

* Police vehicle purchase for FY 2025 is four (4) due to total loss vehicle in FY 2024.

Operating Budget Impact: Regular and ongoing maintenance of the vehicles and equipment.

Key Departments: Public Works, Fleet and various departments

Funding Source	FY 2025	FY 2026	FY 2027	FY 2028	FY 2029	FY 2030	TOTAL
General Fund							
Police Vehicles	\$ 240,000	180,000	180,000	180,000	180,000	180,000	\$1,140,000
Public Works Admin EV	60,000						60,000
Public Works Admin GPS Equipment	10,000						10,000
Facilities Vehicle		65,000					65,000
Fleet Lift Equipment		12,000					12,000
Code Enforcement Hybrid Replacement			30,000				30,000
Code Enforcement Leaf			30,000				30,000
Engineering Vehicle			40,000				40,000
Community Development Prius Replacement EV			45,000		45,000		90,000
Public Works Admin GIS Van			70,000				70,000
Subtotal General	\$ 310,000	257,000	395,000	180,000	225,000	180,000	\$1,547,000
Building Fund							
Building Official and Inspections EV	\$ 50,000	50,000					100,000
Subtotal Building	\$ 50,000	50,000					\$ 100,000
Transportation Fund							
5-Yard Dump Truck & Plow (\$252,000 total)	\$ 63,000						\$ 63,000
Chase Truck	65,000						65,000
Flatbed Trailer (shared)	13,000						13,000
Sign Shop Truck		85,000					85,000
Supervisor Vehicle (shared with Water)		38,000					38,000
Roller			100,000				100,000
1.5 Ton Dump Truck (shared)				50,000			50,000
Tractor with Boom Mower					150,000		150,000
Utility Backhoe (shared)						50,000	50,000
Subtotal Transportation	\$ 141,000	123,000	100,000	50,000	150,000	50,000	\$ 614,000

Vehicles & Equipment (continued)

Funding Source	FY 2025	FY 2026	FY 2027	FY 2028	FY 2029	FY 2030	TOTAL
Water Fund							
5-Yard Dump Truck & Plow (\$252,000 total)	\$ 63,000						\$ 63,000
Flatbed Trailer (shared)	13,000						13,000
Service Truck	94,000				85,000		179,000
Supervisor Vehicle (shared with Transportation)		38,000					38,000
Sprinter Utility Van			80,000				80,000
1.5 Ton Dump Truck (shared)				50,000			50,000
Water Service Van						50,000	50,000
Utility Backhoe (shared)						50,000	50,000
Subtotal Water	\$ 170,000	38,000	80,000	50,000	85,000	100,000	\$ 523,000
Wastewater Fund							
5-Yard Dump Truck & Plow (\$252,000 total)	\$ 63,000						\$ 63,000
Flatbed Trailer (shared)	13,000						13,000
TV Van	300,000						300,000
Service Truck	110,000				85,000		195,000
Chase Truck EV			65,000				65,000
1.5 Ton Dump Truck (shared)				50,000			50,000
Easement Machine				65,000			65,000
Combination Truck					450,000	450,000	900,000
Utility Backhoe (shared)						50,000	50,000
Subtotal Wastewater	\$ 486,000		65,000	115,000	535,000	500,000	\$1,701,000
Stormwater Fund							
5-Yard Dump Truck & Plow (\$252,000 total)	\$ 63,000						\$ 63,000
Mower	75,000						75,000
Flatbed Trailer (shared)	13,000						13,000
Service Truck	105,000						105,000
Combination Truck		800,000					800,000
Crane Truck		85,000					85,000
Chase Truck			65,000				65,000
TV Van			140,000	160,000			300,000
1.5 Ton Dump Truck (shared)				50,000			50,000
Landscape Truck				85,000			85,000
Sweeper EV					450,000		450,000
Large Sweeper						500,000	500,000
Utility Backhoe (Shared)						50,000	50,000
Subtotal Stormwater	\$ 256,000	885,000	205,000	295,000	450,000	550,000	\$2,641,000
TOTAL FUNDING	\$1,413,000	1,353,000	845,000	690,000	1,445,000	1,380,000	\$7,126,000



RS434

CHAPTER 3

URBAN RENEWAL AUTHORITY

The Urban Renewal Authority chapter of the Capital Improvement Plan identifies infrastructure improvements and amenities that enhance the economic vitality and livability of the community. Projects within this chapter include new community facilities, economic development programming, and urban renewal needs. Many of the capital improvement projects listed are in response to growing demands of the community in housing, livability, and economic development. With adoption of the Urban Renewal Plan (2016) and adoption of the five-year action plan (2023), enhancements to downtown and central Milwaukie will provide for a more walkable, accessible, and livable community. The projects listed are not standalone - to best utilize staff resources, these projects are being incorporated as components of larger CIP projects called out in Chapter 1.

METRO PARKS BOND - LOCAL SHARE ALLOCATION GRANT

PAGE	PROJECT NAME	FY 2025	FY 2026	FY 2027	FY 2028	FY 2029	FY 2030	TOTAL
115	Dogwood Park	\$	60,000					\$ 60,000
TOTAL METRO PARKS BOND LOCAL GRANT		\$	60,000					\$ 60,000

URBAN RENEWAL AUTHORITY

PAGE	PROJECT NAME	FY 2025	FY 2026	FY 2027	FY 2028	FY 2029	FY 2030	TOTAL
110	Downtown Main Street Enhancements	\$ 650,000						\$ 650,000
111	Downtown Streetscape Improvements	500,000						500,000
112	McLoughlin Boulevard Intersections	250,000						250,000
112	Milwaukie Bay Parking Reconfiguration	200,000	200,000					400,000
113	Parking Solutions	250,000	250,000					500,000
114	Transit Stop Improvements	300,000						300,000
115	Dogwood Park		400,000					400,000
116	Opportunity Site Access		250,000					250,000
116	Trolley Trail		600,000					600,000
117	Kellogg Dam			1,000,000				1,000,000
TOTAL URBAN RENEWAL AUTHORITY		\$ 2,150,000	1,700,000	1,000,000				\$ 4,850,000



Downtown Main Street Enhancements

Improvements: Urban renewal can be used fund a portion of some activities included in a Main Street Program. Such funding will go towards:

- Replacing First Friday and Farmer's Market Signage
- Installing more wayfinding signage
- Pursuing partnerships to underground utilities
- Installing vertical element and shade at the South Downtown Plaza

Operating Budget Impact: This project will potentially increase ongoing operational needs due to the addition of new infrastructure.

Key Departments: Community Development

	FY 2025	FY 2026	FY 2027	FY 2028	FY 2029	FY 2030	TOTAL
Capital Cost:							
Planning, Engineering, Design	\$ 250,000						\$ 250,000
Construction	400,000						400,000
TOTAL ESTIMATED CAPITAL COST	\$ 650,000						\$ 650,000
Funding Source:							
Urban Renewal Authority	\$ 650,000						\$ 650,000
TOTAL FUNDING	\$ 650,000						\$ 650,000

Downtown Streetscape Improvements



Improvements: Sections of sidewalk on Main Street, between Washington and Jackson, are in disrepair due to tree root growth. To facilitate saving the street trees, while also ensuring Americans with Disability Act (ADA) access, the city will use TIF funds to design and construct new sidewalk.

Operating Budget Impact: Sidewalk repair should reduce ongoing maintenance costs for the city and adjacent property owners.

Key Departments: Engineering, Public Works

	FY 2025	FY 2026	FY 2027	FY 2028	FY 2029	FY 2030	TOTAL
Capital Cost:							
Construction	\$ 500,000						\$ 500,000
TOTAL ESTIMATED CAPITAL COST	\$ 500,000						\$ 500,000
Funding Source:							
Urban Renewal Authority	\$ 500,000						500,000
TOTAL FUNDING	\$ 500,000						\$ 500,000



McLoughlin Boulevard Intersections

Intersection Upgrades

Improvements: McLoughlin Boulevard is owned and maintained by the Oregon Department of Transportation (ODOT). The purpose of allocating TIF resources to McLoughlin is to incentivize repainting and upgrading of crosswalks at Harrison, Monroe, and Washington. Should such improvements trigger the replacement of traffic signals, the vast majority of those costs would need to be covered by the state.

MRC would also like to work with ODOT to make pedestrian and cyclist crossing of McLoughlin more comfortable through modifications to the signal infrastructure and timing.

Operating Budget Impact: None; ODOT maintains McLoughlin Blvd.

Key Departments: Engineering

	FY 2025	FY 2026	FY 2027	FY 2028	FY 2029	FY 2030	TOTAL
Capital Cost:							
Construction	\$ 250,000						\$ 250,000
TOTAL ESTIMATED CAPITAL COST	\$ 250,000						\$ 250,000
Funding Source:							
Urban Renewal Authority	\$ 250,000						\$ 250,000
TOTAL FUNDING	\$ 250,000						\$ 250,000



Milwaukie Bay Parking Reconfiguration

Improvements: TIF resources will be used to plan and implement additional standard vehicle parking spaces by reconfiguring the existing lots and agreeing to any new terms with the Marine Board. This would add more parking capacity at Milwaukie Bay Park.

Operating Budget Impact: The project would increase operational expenses by adding infrastructure.

Key Departments: Community Development, Engineering, Public Works

	FY 2025	FY 2026	FY 2027	FY 2028	FY 2029	FY 2030	TOTAL
Capital Cost:							
Planning, Engineering, Design	\$ 50,000	50,000					\$ 100,000
Construction	150,000	150,000					300,000
TOTAL ESTIMATED CAPITAL COST	\$ 200,000	200,000					\$ 400,000
Funding Source:							
Urban Renewal Authority	\$ 200,000	200,000					\$ 400,000
TOTAL FUNDING	\$ 200,000	200,000					\$ 400,000

Parking Solutions



Improvements:

TIF resources will be used to implement many of the near-term actions identified in the city's 2018 adopted Downtown Parking Management Plan. Such projects will include:

- New signage to reflect zone timing changes recommended in plan
- Better delineation of loading zones
- Development of shared parking agreements with new downtown developments
- Installation of secure bike parking downtown to incentivize non-auto trips
- Study and potential acquisition of paid parking technology for downtown

Operating Budget Impact:

The project would increase operational expenses by adding infrastructure.

Key Departments:

Community Development, Engineering, Public Works

	FY 2025	FY 2026	FY 2027	FY 2028	FY 2029	FY 2030	TOTAL
Capital Cost:							
Planning, Engineering, Design	\$ 100,000	50,000					\$ 150,000
Construction	150,000	200,000					350,000
TOTAL ESTIMATED CAPITAL COST	\$ 250,000	250,000					\$ 500,000
Funding Source:							
Urban Renewal Authority	\$ 250,000	250,000					\$ 500,000
TOTAL FUNDING	\$ 250,000	250,000					\$ 500,000

Transit Stop Improvements



Improvements: Transit stops in Milwaukie are owned and maintained by TriMet. The purpose of the project is to facilitate improvements to bus shelters in partnership projects with TriMet.

Operating Budget Impact: None; anticipated to be owned and maintained by TriMet.

Key Departments: Community Development, Planning

	FY 2025	FY 2026	FY 2027	FY 2028	FY 2029	FY 2030	TOTAL
Capital Cost:							
Planning, Engineering, Design	\$ 50,000						\$ 50,000
Construction		250,000					250,000
TOTAL ESTIMATED CAPITAL COST	\$ 300,000						\$ 300,000
Funding Source:							
Urban Renewal Authority	\$ 300,000						\$ 300,000
TOTAL FUNDING	\$ 300,000						\$ 300,000

Dogwood Park



Improvements: Through a joint planning project with North Clackamas Parks and Recreation District, a framework plan is being created to help integrate Dogwood Park into the new built environment in South Downtown along with the Coho Point development site to the north. This project will implement the framework plan. The estimated total project cost (as of 2016) is \$480,000 with additional potential funding from the Urban Renewal Area revenue.

Operating Budget Impact: None

Key Departments: Public Works, City Manager's Office

	FY 2025	FY 2026	FY 2027	FY 2028	FY 2029	FY 2030	TOTAL
Capital Cost:							
Planning, Engineering, Design	\$	100,000					\$ 100,000
Construction		360,000					360,000
TOTAL ESTIMATED CAPITAL COST	\$	460,000					\$ 460,000
Funding Source:							
Urban Renewal Authority	\$	400,000					\$ 400,000
General Fund Public Works Admin - Metro Parks Bond - Local Share Allocation		60,000					60,000
TOTAL FUNDING	\$	460,000					\$ 460,000



Opportunity Site Access

Improvements: The city's updated Transportation System Plan, expected to be complete in 2024, will identify new projects that could be funded with TIF dollars in a 5-10 year period. A small amount of early funding has been identified to acquire needed property adjacent to Harrison Street.

Operating Budget Impact: Unknown

Key Departments: Community Development

	FY 2025	FY 2026	FY 2027	FY 2028	FY 2029	FY 2030	TOTAL
Capital Cost:							
Land / ROW Acquisition	\$	250,000					\$ 250,000
TOTAL ESTIMATED CAPITAL COST	\$	250,000					\$ 250,000
Funding Source:							
Urban Renewal Authority	\$	250,000					\$ 250,000
TOTAL FUNDING	\$	250,000					\$ 250,000



Trolley Trail

Milwaukie Bay Park

Improvements: Re-align the trolley trail within Milwaukie Bay Park as part of the Phase III improvements to the park. The realignment of the trail will reduce conflicts between cyclists and pedestrians, who currently share a sidewalk, and facilitate the development of the overall project.

Operating Budget Impact: None

Key Departments: Community Development, Engineering, Public Works, City Manager

	FY 2025	FY 2026	FY 2027	FY 2028	FY 2029	FY 2030	TOTAL
Capital Cost:							
Construction	\$	600,000					\$ 600,000
TOTAL ESTIMATED CAPITAL COST	\$	600,000					\$ 600,000
Funding Source:							
Urban Renewal Authority	\$	600,000					\$ 600,000
TOTAL FUNDING	\$	600,000					\$ 600,000

Kellogg Dam

Removal & Pedestrian Undercrossing

Improvements: Prior recommendations to use TIF funds to establish a dedicated bicycle and pedestrian connection across McLoughlin Boulevard. A natural location for such a crossing is under the Kellogg Bridge on OR 99E (McLoughlin). The city aspires to restore Kellogg Creek by removing a dam that is structurally integral to the bridge. Restoring the creek will provide critical fish habitat for endangered and threatened species while also facilitating construction of a separated crossing for bikes and pedestrians that would directly connect downtown to Milwaukie Bay Park.

ODOT owns 99E and is responsible for any improvements to the highway and Kellogg Bridge. The cost of bridge replacement far exceeds the financial capabilities of the city, and more specifically, the tax increment financing district. The purpose of programming TIF resources to the dam removal project is to catalyze action and leverage funding at the state and federal levels. Prior to releasing funds, however, the MRC would need direct assurance (via formal agreement) that state resources will be committed to the project.



Operating Budget Impact: Unknown impact due to ODOT/city partnership.

Key Departments: Community Development, Engineering, Planning, Public Works

	FY 2025	FY 2026	FY 2027	FY 2028	FY 2029	FY 2030	TOTAL
Capital Cost:							
Construction	\$		1,000,000				\$ 1,000,000
TOTAL ESTIMATED CAPITAL COST	\$		1,000,000				\$ 1,000,000
Funding Source:							
Urban Renewal Authority	\$		1,000,000				\$ 1,000,000
TOTAL FUNDING	\$		1,000,000				\$ 1,000,000



RS444

CHAPTER 4

UNFUNDED

The unfunded chapter includes projects from city plan that do not have identified resources at this time. Unfunded projects in the CIP help inform future grant applications and inform discussions about funding allocation through sources not currently available to the city. At this time, funds that may become available for capital projects over the next fiscal years include additional bonds, state or federal infrastructure stimulus and competition grants.

Should significant reductions in funding occur after adoption of the budget, projects will need to be deferred or defunded until resources can be identified.

UNFUNDED – SUMMARY BY PROJECT TOTALS

PAGE	PROJECT	ESTIMATED COST
120	29th Avenue-Monroe Street Greenway Connector	\$ 3,400,000
120	32nd Avenue Improvements	1,500,000
120	37th Avenue Improvements	1,560,000
121	51st Avenue and Casa Del Rey Drive	TBD
121	Bicycle & Pedestrian Railroad Avenue Overpass	4,678,000
121	Bowman Street and Brae Street	TBD
122	Downtown Parking Garage	33,484,000
122	Fiber Optic Service	TBD
123	Harmony Road	1,500,000
123	Harrison Street Capacity Improvements	8,300,000
124	Hwy 224 & Hwy 99E Improvements	27,561,000
125	Island Station Neighborhood Greenway	6,150,000
125	Lake Road SAFE Improvements (Where Else Lane to Harmony Road)	1,560,000
125	Lake Road/Harmony Road/Railroad Avenue Intersection	48,517,000
126	Milwaukie Bay Park	12,600,000
127	Milwaukie Bay Park Trail Improvements	TBD
127	North Milwaukie Industrial Area Street Improvements	1,900,000
127	Ochoco Street & Roswell Street Bicycle & Pedestrian Connections	TBD
128	Olsen Street	TBD
128	Railroad Avenue	10,136,000
129	Springwater Corridor Trail Bicycle & Pedestrian Connections Improvements	TBD
130	Where Else Lane	TBD
TOTAL		\$ 162,846,000



29th Avenue - Monroe Street Greenway Connector

29th Avenue to Railroad Avenue

- Operating Budget Impact:** This project would increase operational expenses by increasing infrastructure.
- Source:** TSP, CMLUTP, URAP
- Key Departments:** Community Development, Engineering, Planning
- Potential Funding Sources:** Transportation, Urban Renewal Area
- Estimated Capital Cost:** \$3,400,000



32nd Avenue Improvements

Roswell Street to Sherrett Street

Reconstruct portions of existing sidewalk on 32nd Avenue from Roswell Street to city limits. Pave 32nd Avenue from city limits to Van Water Street.

- Estimated Capital Cost:** \$1,500,000



37th Avenue Improvements

Harrison Street to International Way

Construct continuous sidewalk on 37th Avenue between Harrison Street and International Way. Pave 37th Avenue from International Way to Railroad Avenue and from Monroe Street to Harrison Street.

- Operating Budget Impact:** Unknown
- Source:** SAFE, SSMP, BPAP, TSP, RTP (#10096)
- Key Departments:** Engineering
- Potential Funding Sources:** SAFE, SSMP, Transportation (State Gas Tax)
- Estimated Capital Cost:** \$1,560,000



51st Avenue & Casa Del Rey Drive

Lake Road to North Clackamas Park

Install pedestrian facilities.

Estimated Capital Cost: TBD

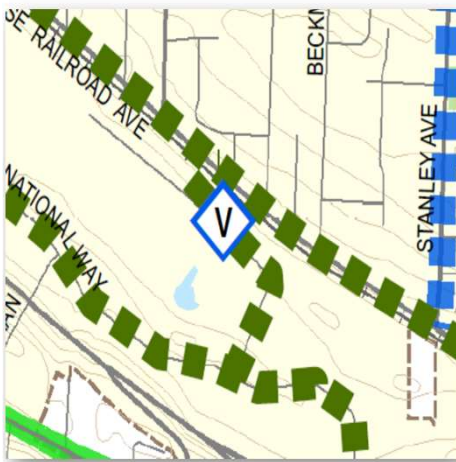

Bicycle & Pedestrian Railroad Avenue Overpass

Railroad Avenue and International Way

Establish a dedicated bicycle and pedestrian connection across Railroad Ave and the railroad tracks that connects Railroad Avenue with International Way and connections to transit. The purpose of this project is to improve north-south bicycle and pedestrian connections, and enhance the accessibility to transit, and the Milwaukie Business Employment area.

Operating Budget Impact: Project would add infrastructure by constructing a new multiuse path.

Source: TSP, RTP (#11533), SAFE

Key Departments: Engineering

Potential Funding Sources: SAFE, Transportation

Estimated Capital Cost: \$4,678,000



Bowman Street and Brae Street

Bowman-Brae Park to City Limits

Install pedestrian facilities and maintain roadway pavement.

Estimated Capital Cost: TBD



Downtown Parking Garage

Construct a 3- to 4-story public parking structure with retail at ground floor for visitor/employee parking. The purpose is to expand off-street parking supply downtown.

Operating Budget Impact: The project would increase operational expenses by adding infrastructure.

Source: TSP, RTP (#11175)

Key Departments: Community Development, Engineering

Potential Funding Sources: Transportation, Urban Renewal Area

Estimated Capital Cost: \$33,484,000



Fiber Optic Service

NMIA and Downtown Milwaukie

Extend high speed fiber optic service to the NMIA and downtown Milwaukie as funding becomes available. Clackamas County's Economic Development division oversees the implementation funding for dark fiber and staff will work with them on funding allocation and grant writing.

Operating Budget Impact: The project will potentially increase ongoing operational needs due to addition of new infrastructure.

Source: NMIA

Key Departments: Community Development

Potential Funding Sources: TBD

Estimated Capital Cost: TBD



Harmony Road

International Way to City Limits

Install pedestrian facilities along Harmony Road from International Way to the city limits.

Estimated Capital Cost: \$1,500,000

Harrison Street Capacity Improvements

McLoughlin Boulevard to 42nd Avenue



Widen to standard three lane cross-section with bike lanes, filling in last portion of on-street bike lanes along one of the city's principle arterials.

Operating Budget Impact: Unknown

Source: Engineering

Key Departments: Engineering

Potential Funding Sources: Transportation

Estimated Capital Cost: \$8,300,000



Hwy 224 & Hwy 99E Improvements

PLANNING

HWY 224 & HWY 99E Refinement Plan

Conduct refinement study to establish alternative mobility targets for Hwy 224 and McLoughlin Blvd (Hwy 99) for locations not meeting applicable state targets and explore ways to minimize barrier effect and improve pedestrian, auto, and freight mobility.

Hwy 224 Upgrades

Pedestrian Improvements at Hwy 224: This project will reconfigure the intersections of Harrison Street, 37th Avenue, and Freeman Way at Highway 224 by adding left turn lanes and protected signal phasing on the local streets together with reconfiguring the intersections as needed to improve overall intersection functioning.

Hwy 99 Upgrades

East Sidewalk Improvements: Improve the east sidewalk from north of Harrison Street to Hwy 224. These improvements are to enhance pedestrian safety and signal visitors that they are entering downtown.

Sidewalks from Harrison Street to UPRR: Address gaps in pedestrian system and improve connection between downtown and Milwaukie Bay Park. Provide grade-separated crossing.

Crosswalk/Intersection Upgrades: Improve all existing crossings of McLoughlin Boulevard, using better signage, extended crossing times, and distinctive crosswalk paving. Construct improvements at Harrison Street, Monroe Street, Jackson Street, Jefferson Street, and Washington Street to enhance bike/pedestrian crossings to the Trolley Trail and Milwaukie Bay Park.

Intersection improvements at McLoughlin Boulevard and River Road: Consolidate a single access point for the area at Bluebird Street with full intersection treatment and signalization or add second northbound left-turn lane at River Road to reduce congestion and improve safety.

Construct multiuse walkway from McLoughlin Boulevard to Kronberg Park Multiuse Path south of UPRR to complete pedestrian connection.

Operating Budget Impact:	Unknown
Source:	TSP, RTP (#11620, #11537, #10098, #11539, #11623), URAP, DRFP
Key Departments:	Engineering
Potential Funding Sources:	Transportation
Estimated Capital Cost:	\$27,561,000



Island Station Neighborhood Greenway

19th Avenue and Sparrow Street

Designate 19th Avenue and Sparrow Street as a neighborhood greenway connecting the south end of Kellogg Creek Trail with the Trolley Trail.

Operating Budget Impact: This project will potentially increase ongoing operational needs due to the addition of new infrastructure.

Source: TSP, RTP (#11622)

Key Departments: Engineering

Status: Unfunded

Potential Funding Sources: SAFE, Transportation

Estimated Capital Cost: \$6,150,000



Lake Road SAFE Improvements

Where Else Lane to Harmony Road/Railroad Avenue

Fill in sidewalk gaps on both sides of street, widen to provide for standard three-way cross-section west of Highway 224, fill in gaps in existing bicycle network with bike lanes, provide intersection improvements, and ADA ramps.

Operating Budget Impact: This project will potentially increase ongoing operational needs due to the addition of new infrastructure.

Source: BPAP, TSP, RTP (#10094)

Key Departments: Engineering

Potential Funding Sources: SAFE, Transportation

Estimated Capital Cost: \$1,560,000



Lake Road/Harmony Road/Railroad Avenue Intersection

Railroad crossing and intersection improvements based on further study of intersection operations, including bicycle and pedestrian facilities to be undertaken jointly by the city and Clackamas County.

Operating Budget Impact: This project will potentially increase ongoing operational needs due to the addition of new infrastructure.

Source: RTP (#10000)

Key Departments: Engineering, Clackamas County

Potential Funding Sources: SAFE, Transportation

Estimated Capital Cost: \$48,517,000

Milwaukie Bay Park

Final Design Implementation



Implementation of North Clackamas Parks and Recreation District's final design of Milwaukie Bay Park. The estimated project cost (as of 2022) is approximately \$12.6 million.

Operating Budget Impact: None

Key Departments: Public Works, Community Development, Engineering, City Manager

Estimated Capital Cost: \$12,600,000



Milwaukie Bay Park Trail Improvements

Milwaukie Bay Park to 19th Avenue

Construct trail improvements to create an ADA-accessible path from the Milwaukie Bay Park to 19th Avenue.

Operating Budget Impact: None

Source: BPAP, ADA

Key Departments: Engineering

Potential Funding Sources: Transportation

Estimated Capital Cost: TBD



North Milwaukie Industrial Area Street Improvements

Stubb Street, Beta Street, Hanna Harvester Street

Construct street improvements on Stubb Street, Beta Street and Hanna Harvester Street.

Estimated Capital Cost: \$1,900,000

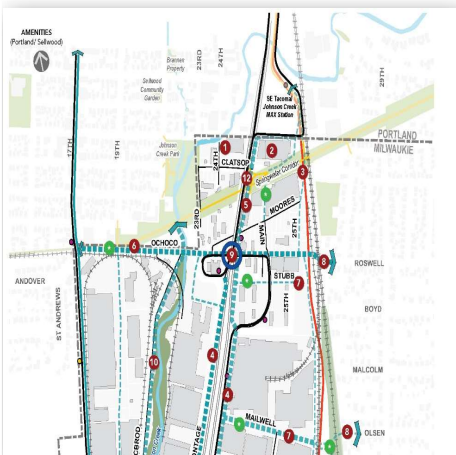

Ochoco Street & Roswell Street Bicycle & Pedestrian Connections

Extend bicycle and pedestrian connections along Ochoco Street to Roswell Street across the railroad tracks to improve connectivity and circulation to/from the project area.

Operating Budget Impact: This project constructs a new bridge and supporting infrastructure, increasing operational expenses.

Source: NMIA Plan

Key Departments: Community Development, Planning, Engineering, Public Works

Potential Funding Sources: Transportation

Estimated Capital Cost: TBD



Olsen Street

Dead End to 42nd Avenue

Install pedestrian facilities and maintain roadway pavement from the western end of Olsen Street to 42nd Avenue. Water system improvements from 29th Avenue to 32nd Avenue.

Estimated Capital Cost: TBD



Railroad Avenue

37th Avenue to Harmony Road

This project will have a pedestrian component and a public transit component. The pedestrian aspect involves the construction of a new multi-use path located along one side of Railroad Avenue between 37th Avenue and Harmony Road. The public transit aspect involves providing bus service which will extend to the Clackamas Town Center and points further east. The purpose of the project is to address gaps in the pedestrian and bicycle systems and improve transit facilities.

Estimated Capital Cost: \$10,136,000

Springwater Corridor Trail Bicycle & Pedestrian Connections Improvements

Springwater Corridor to Tacoma Station Area



Enhance bicycle and pedestrian facilities within residential neighborhood and establish bicycle and pedestrian connections from Springwater Corridor Trail to Tacoma Station Area.

- Improved connection from Springwater Trail to Pendleton Site (Ramps) – Construct ramps to improve existing connection of Springwater Trail to Pendleton site at Clatsop Street.
- Improved connection from Springwater Trail to Pendleton Site (Widened Undercrossing) – Widen existing undercrossing to improve connection of Springwater Trail to Pendleton site at Clatsop Street.
- Improved connection from Springwater Trail to Pendleton Site (Tunnel) – Construct tunnel under Springwater Trail to improve connection to Pendleton site at Clatsop Street.
- Improved connection from Springwater Trail to McLoughlin Boulevard – Construct stairs or other facility to connect Springwater Trail to west side of McLoughlin Boulevard.
- Bicycle/Pedestrian Improvements to Main Street – Construct multiuse path or other improved bike/ped facilities to Main Street to provide safer connection between downtown Milwaukie and Tacoma Station.
- Bicycle/Pedestrian connection over Johnson Creek – Construct bike/ped bridge over Johnson Creek along Clatsop Street at 23rd Avenue to connect Tacoma Station area with adjacent neighborhood.
- Improved Bicycle/Pedestrian connections on West Side of Tacoma Station Area – Improve bike/ped connections to adjacent neighborhood to west of Tacoma Station area at Ochoco Street and Milport Road.

Operating Budget Impact: This project will potentially increase ongoing operational needs due to the addition of new infrastructure.

Source: TSP, RTP (#11174), NMIA Plan

Key Departments: Engineering

Potential Funding Sources: Transportation

Estimated Capital Cost: TBD

Where Else Lane

Lake Road to Bowman Brae Park

Install pedestrian facilities and maintain roadway pavement.

Estimated Capital Cost: TBD





CITY OF MILWAUKIE

Special thanks to:

City Council

Lisa Batey, mayor
Adam Khosroabadi
Robert Massey, council president
Shane Abma
Rebecca Stavenjord

Citizens Utility Advisory Board

David Chitsazan
William Johnson
Mary Rowe
Leslie Schockner
Sofie Sherman-Burton

Budget Committee Community Members

Leslie Schockner, chair
David Chitsazan
William Johnson
Mary Rowe
Sofie Sherman-Burton

Public Safety Advisory Board

Jay Panagos, chair (unincorporated)
Elvis Clark, member (Ardenwald-Johnson Creek)
Pam Denham, member (Island Station)
Christine Giatti, member (Lake Road)
Stephan Lashbrook, member (Lewelling)
Jessica Peterson, member (Hector Campbell)
Shimron Tubman, member (Linwood)
Ashley Akerberg, member at-large
Christina Cole, member at-large
David Enciso, member at-large
vacant, member (Historic Milwaukie)

City Staff

Taylor Bremont, Keisha Brewster, Ryan Burdick,
Emilie Bushlen, Mattie Dulka, Joe Gardner,
Mike Harman, Shane Hart, Scott Pierce,
Judy Serio, Kelli Tucker, and Keven Worden

CONTACT US

Finance

Finance Director: Michael Osborne

City Manager

Acting City Manager: Emma Sagor

Acting Assistant City Manager: Joseph Briglio

Engineering Services

City Engineer: Jennifer Garbely

Assistant City Engineer: Jeff Tolentino

Community Development

Community Development Director: Joseph Briglio

Public Works

Public Works Director: Peter Passarelli



CITY OF MILWAUKIE

10501 SE Main Street, Milwaukie, OR 97222 503.786.7555 www.milwaukieoregon.gov



**RS 8. C. 6/4/24
Presentation**



CITY OF MILWAUKIE

**APPROVED
BIENNIUM
BUDGET
2025-2026**

**Council Meeting
June 4, 2024**

2025-26 Budget *North Stars*



BUDGET AT A GLANCE

Total citywide budget:
\$192 Million

City's tax rate:
**\$4.1367 per \$1,000 of
assessed value**

Full-time equivalent
employees as of
completion of the
biennium: **149.25**

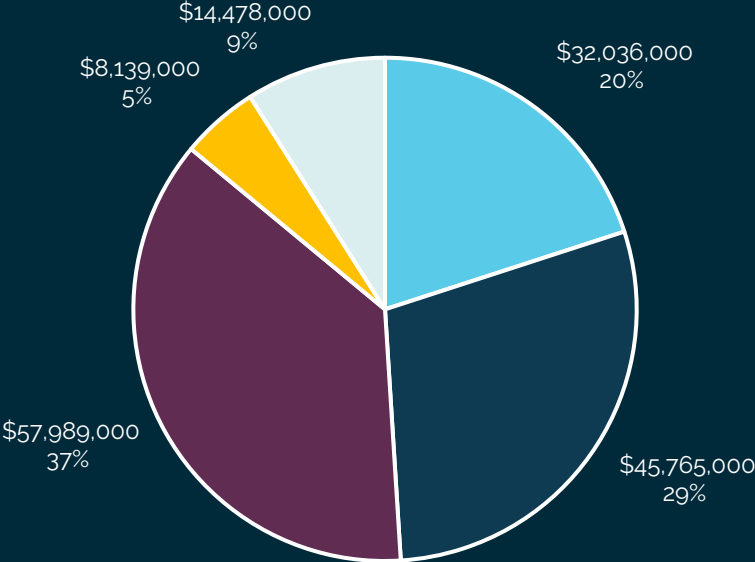

- Materials and Services
- Personnel
- Capital
- Debt Service
- Transfers



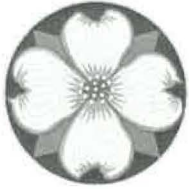

PUBLIC HEARING ATTENDANCE SIGN-UP SHEET

If you wish to have appeal standing and/or to be on the mailing list for Council information from tonight's hearing, please sign-in below.

6/4/2024

8. C. 2025-2026 Biennial City Budget and Capital Improvement Plan Adoption – Resolution

Land Use File No. (none)

NAME	ADDRESS	PHONE	EMAIL